

Technical Data Sheet

Side View Red SMD LEDs

57-21SYGC/S530-XX/TR8

Features

- Fluorescence Type
- High Luminous Intensity
- High Efficiency
- Pb-free.
- The product itself will remain with RoHS compliant version



Descriptions

The 57-21series is available in soft orange, green, blue and yellow. Due to the package design, the LED has wide viewing angle and optimized light coupling by inter reflector. This feature makes ideal for light pipe application. The low current requirement makes this device ideal for portable equipment or any other application where power is at a premium.

Applications

- OA Equipment
- Backlighting of Full Color LCD
- Replacement of Conventional Light Bulbs and Fluorescent Lamps

Device Selection Guide

Chip	Emitted Color	Resin Color
Material		
AlGaInP	Brilliant Yellow Green	Water Clear

Technical Data Sheet
Side View Red SMD LEDs

57-21SYGC/S530-XX/TR8

Package Dimensions

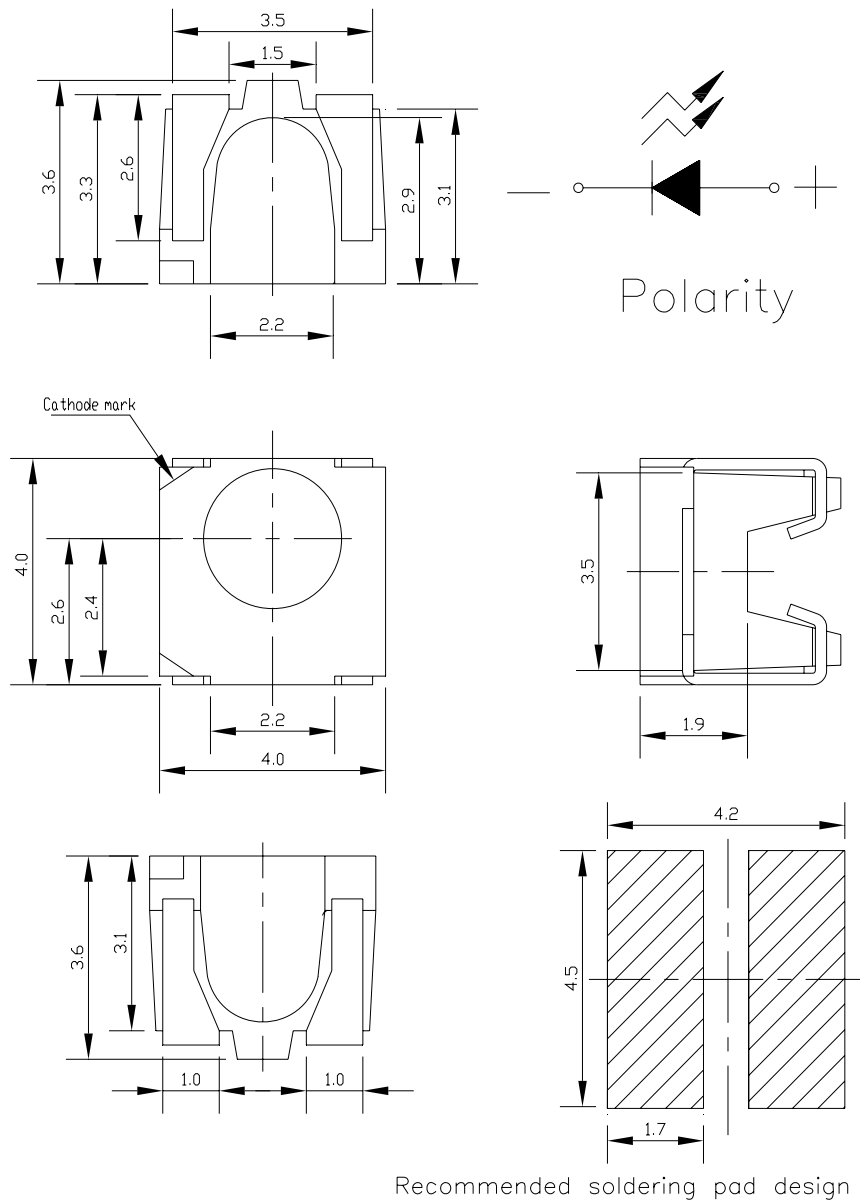

Recommended soldering pad design

Note: The tolerances unless mentioned is ± 0.1 mm ,Unit = mm

Technical Data Sheet

Side View Red SMD LEDs

57-21SYGC/S530-XX/TR8

Absolute Maximum Ratings (Ta=25°C)

Parameter	Symbol	Rating	Unit
Reverse Voltage	V _R	5	V
Forward Current	I _F	25	mA
Peak Forward Current (Duty 1/10 @1KHz)	I _{FP}	60	mA
Power Dissipation	P _d	60	mW
Electrostatic Discharge(HBM)	ESD	2000	V
Operating Temperature	T _{opr}	-40 ~ +85	°C
Storage Temperature	T _{stg}	-40 ~+100	°C
Soldering Temperature	T _{sol}	Reflow Soldering : 260 °C for 10 sec. Hand Soldering : 350 °C for 3 sec.	

Technical Data Sheet
Side View Red SMD LEDs

57-21SYGC/S530-XX/TR8

Electro-Optical Characteristics (Ta=25°C)

Parameter	Symbol	*Chip Rank	Min.	Typ.	Max.	Unit	Condition
Luminous Intensity	I _v	E3	32	51	-----	mcd	I _F =20mA
		E4	41	61	-----		
		E5	53	73	-----		
Viewing Angle	2θ 1/2	-----	-----	120	-----	deg	I _F =20mA
Peak Wavelength	λ _p	-----	-----	575	-----	nm	I _F =20mA
Dominant Wavelength	λ _d	-----	-----	573	-----	nm	I _F =20mA
Spectrum Radiation Bandwidth	Δλ	-----	-----	20	-----	nm	I _F =20mA
Forward Voltage	V _F	-----	1.7	2.0	2.4	V	I _F =20mA
Reverse Current	I _R	-----	-----	-----	10	μA	V _R =5V

*57-21SYGC/S530-XX/TR8

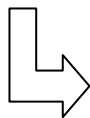

Chip Rank

Technical Data Sheet
Side View Red SMD LEDs

57-21SYGC/S530-XX/TR8

Typical Electro-Optical Characteristics Curves

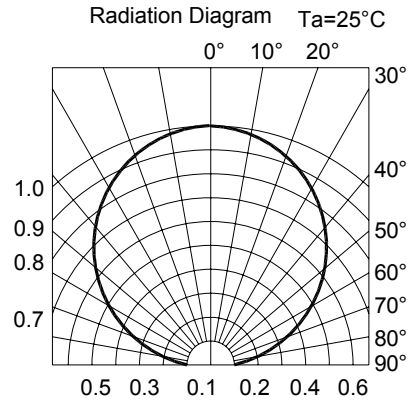
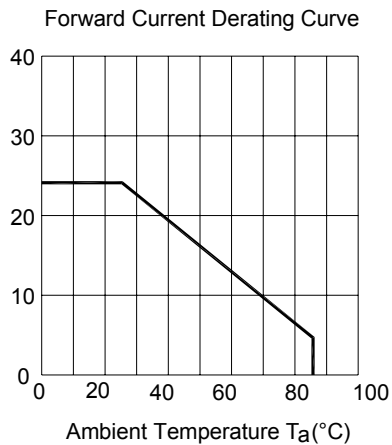
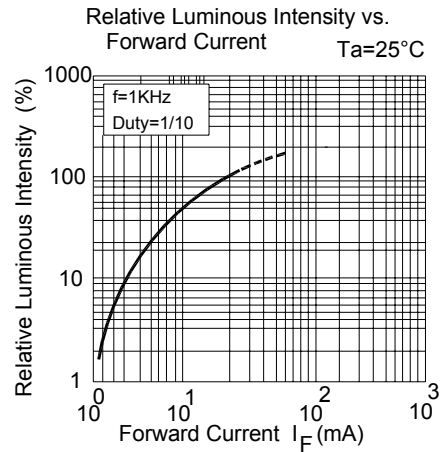
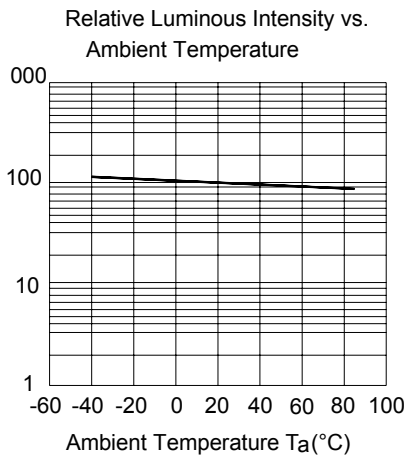
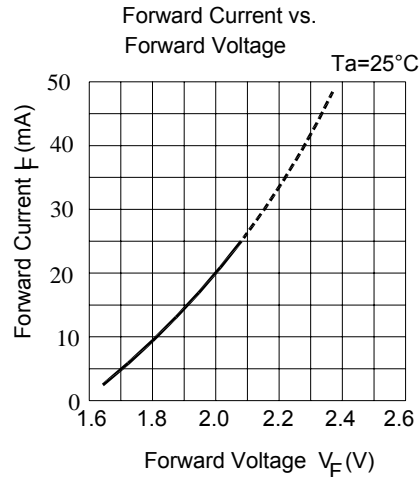
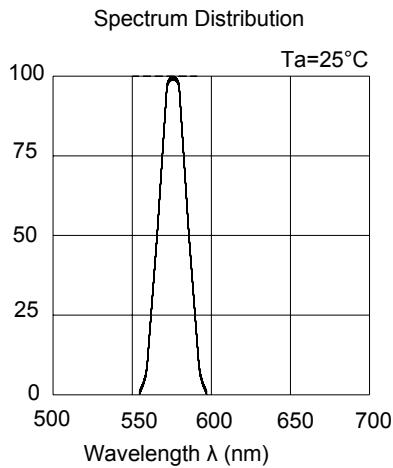

Technical Data Sheet
Side View Red SMD LEDs

57-21SYGC/S530-XX/TR8

Label Explanation

CAT: Luminous Intensity Rank

HUE: Dom. Wavelength Rank

REF: Forward Voltage Rank

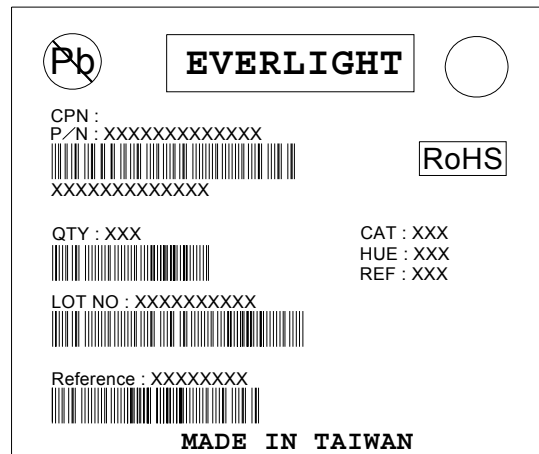

Reel Dimensions

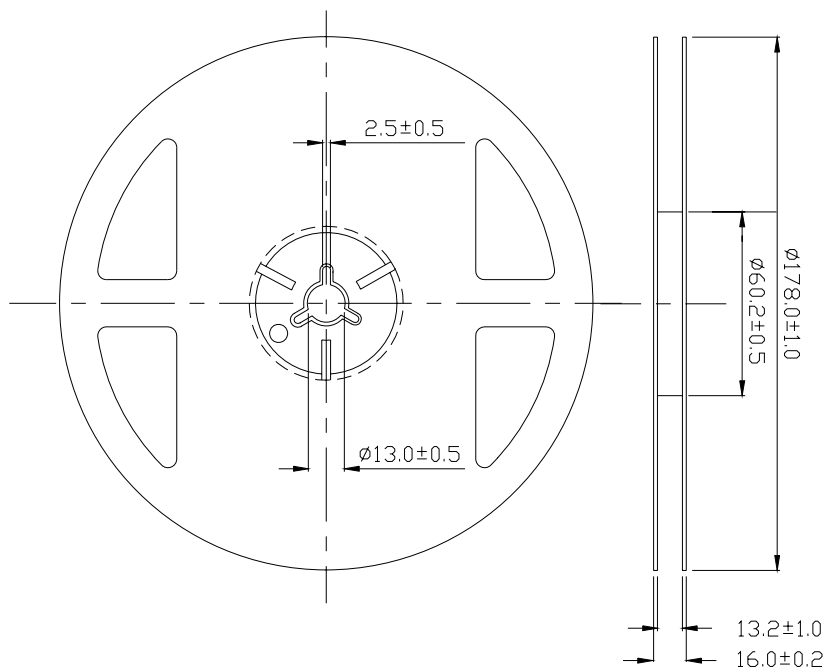

Note: The tolerances unless mentioned is ± 0.1 mm ,Unit = mm

Technical Data Sheet
Side View Red SMD LEDs

57-21SYGC/S530-XX/TR8

Carrier Tape Dimensions: Loaded Quantity 500 pcs Per Reel.

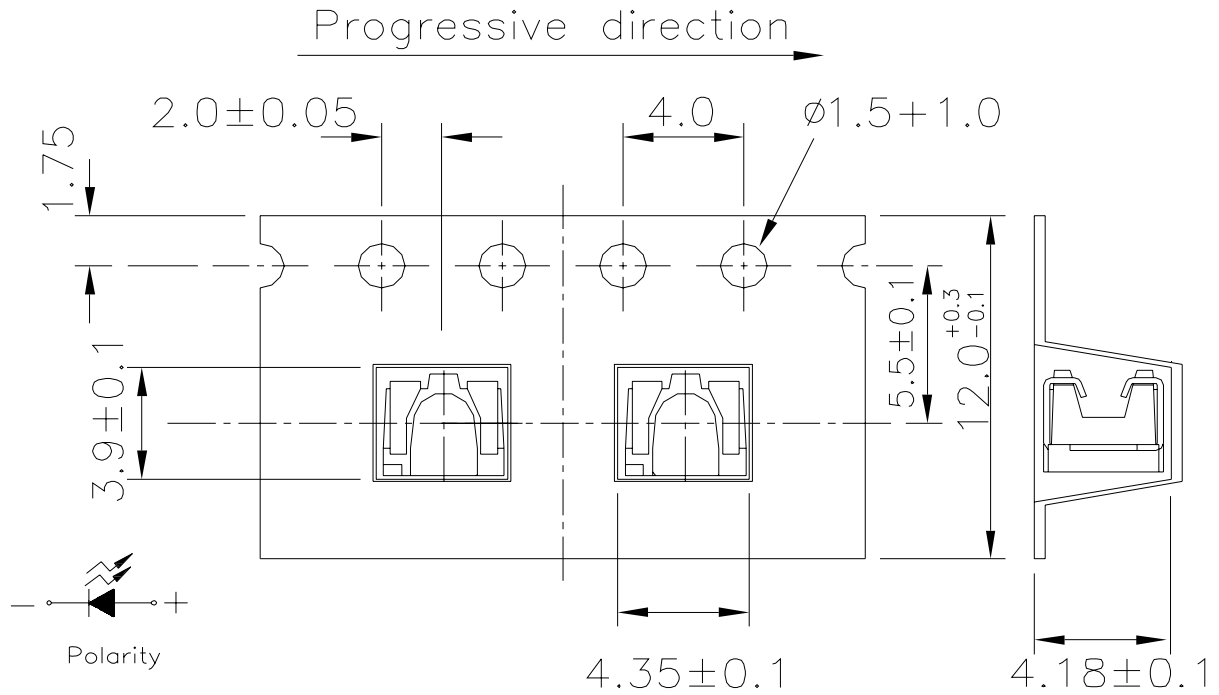

Note: The tolerances unless mentioned is ± 0.1 mm ,Unit = mm

Moisture Resistant Packaging

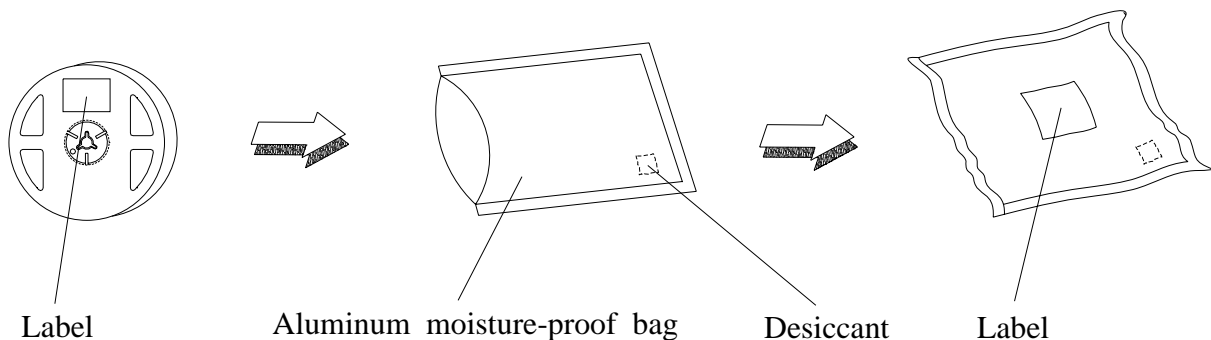

Technical Data Sheet
Side View Red SMD LEDs

57-21SYGC/S530-XX/TR8

Reliability Test Items And Conditions

The reliability of products shall be satisfied with items listed below.

Confidence level : 90%

LTPD : 10%

No.	Items	Test Condition	Test Hours/Cycles	Sample Size	Ac/Re
1	Reflow Soldering	Temp. : 260°C±5°C Max. 10 sec.	6 min	22 PCS.	0/1
2	Temperature Cycle	H : +100°C 15min ∫ 5 min L : -40°C 15min	300 Cycles	22 PCS.	0/1
3	Thermal Shock	H : +100°C 5min ∫ 10 sec L : -10°C 5min	300 Cycles	22 PCS.	0/1
4	High Temperature Storage	Temp. : 100°C	1000 Hrs.	22 PCS.	0/1
5	Low Temperature Storage	Temp. : -40°C	1000 Hrs.	22 PCS.	0/1
6	DC Operating Life	I _F = 20 mA	1000 Hrs.	22 PCS.	0/1
7	High Temperature / High Humidity	85°C / 85%RH	1000 Hrs.	22 PCS.	0/1

Technical Data Sheet
Side View Red SMD LEDs

57-21SYGC/S530-XX/TR8

Precautions For Use

1. Over-current-proof

Customer must apply resistors for protection, otherwise slight voltage shift will cause big current change (Burn out will happen).

2. Storage

2.1 Do not open moisture proof bag before the products are ready to use.

2.2 Before opening the package: The LEDs should be kept at 30°C or less and 90%RH or less.

2.3 After opening the package: The LED's floor life are 168 hours under 30 deg C or less and 60% RH or less.

If unused LEDs remain, it should be stored in moisture proof packages.

2.4 If the moisture absorbent material (silica gel) has faded away or the LEDs have exceeded the storage time, baking treatment should be performed using the following conditions.

Baking treatment : 60±5°C for 24 hours.

3. Soldering Condition 1~5 °C / Sec.

3.1 Pb-free solder temperature profile

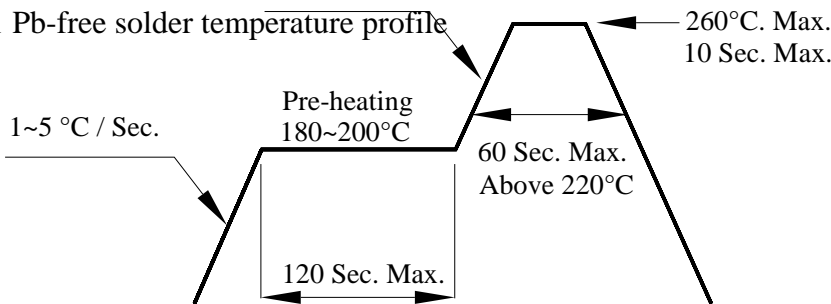

3.2 Reflow soldering should not be done more than two times.

3.3 When soldering, do not put stress on the LEDs during heating.

3.4 After soldering, do not warp the circuit board.

Technical Data Sheet

Side View Red SMD LEDs

57-21SYGC/S530-XX/TR8

4.Soldering Iron

Each terminal is to go to the tip of soldering iron temperature less than 350°C for 3 seconds within once in less than the soldering iron capacity 25W. Leave two seconds and more intervals, and do soldering of each terminal. Be careful because the damage of the product is often started at the time of the hand solder.

5.Repairing

Repair should not be done after the LEDs have been soldered. When repairing is unavoidable, a double-head soldering iron should be used (as below figure). It should be confirmed beforehand whether the characteristics of the LEDs will or will not be damaged by repairing.

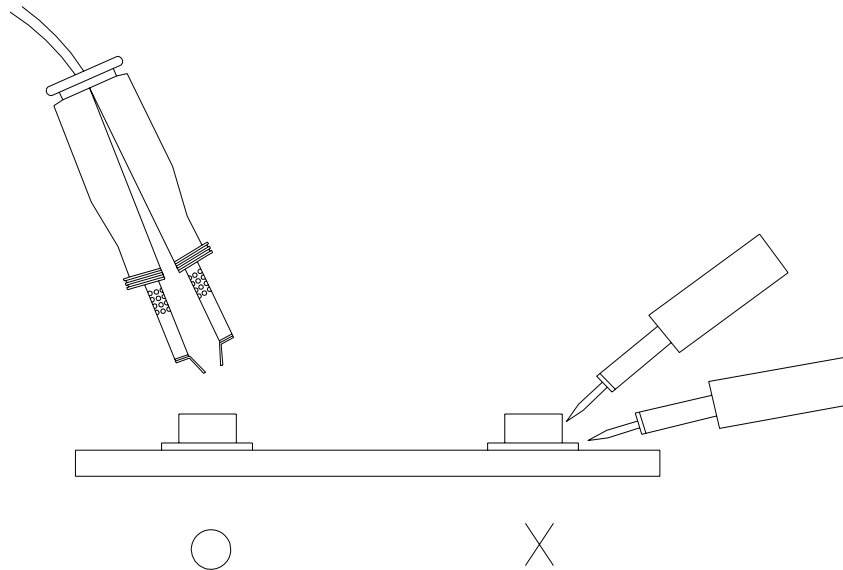

EVERLIGHT ELECTRONICS CO., LTD.
Office: No 25, Lane 76, Sec 3, Chung Yang Rd,
Tucheng, Taipei 236, Taiwan, R.O.C

Tel: 886-2-2267-2000, 2267-9936
Fax: 886-2267-6244, 2267-6189, 2267-6306
<http://www.everlight.com>