

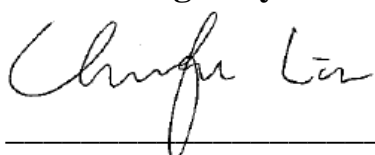

Harvatek Surface Mount CHIP LEDs Approval Sheet

Model No.: HT-358FCH

Acknowledged by



Section Manager
Production Engineering Dept.



Manager
Production Engineering Dept.

Official Product	HT Part No. HT-358FCH	Your Part No.		Data Sheet No.
Tentative Product	*****	*****		HDS-358-K221
Specifications are subject to changes for improvement without advance notice. Proprietary data, drawings, and company confidential all rights reserved.		Mar-7, 2005	Version of 1.0	Page 1/15

INTRODUCTION 3

PRODUCT SPECIFICATION 4

 ATTENTION: ELECTRICSTATIC DISCHARGE (ESD) PROTECTION 4

LABEL SPEC: 5

CHARACTERISTICS OF HT-358FCH SERIES 8

 TAPE DIMENSION 9

 REEL DIMENSION 10

 PACKING MODEL 10

PRECAUTION OF APPLICATION 11

 DESIGNING 1: SOLDERING PATTERN 11

 DESIGNING 2: CIRCUIT LAYOUT 11

 DESIGNING 3: ELECTRIC STATIC DISCHARGE (ESD) PROTECTION 11

 DESIGNING 4: MAX RATING 11

 DRY PACK 11

 STORAGE 12

 BAKING 12

 SOLDERING 13

 RE-FLOW SOLDERING 13

LEAD SOLDER PROFILE 13

LEAD-FREE SOLDER PROFILE 14

 REWORK 14

 CLEANING 14

 CAUTIONS OF PICK AND PLACE 14

RELIABILITY TEST 15

Official Product	HT Part No. HT-358FCH	Your Part No.		Data Sheet No.
Tentative Product	*****	*****		HDS-358-K221
Specifications are subject to changes for improvement without advance notice. Proprietary data, drawings, and company confidential all rights reserved.		Mar-7, 2005	Version of 1.0	Page 2/15

Introduction

- The information contained herein is presented only as a guide for the applications of our products. No responsibility is assumed by HARVATEK for any infringements of intellectual properties or other rights of the third parties which may result from their use.
- Harvatek is continually improving the quality of its products. Nevertheless, semiconductor devices in general can malfunction or fail due to their inherent electrical sensitivity and vulnerability to physical stress. It is the responsibility of the buyer, when utilizing HARVATEK products, to comply with the standards of safety in making a safe design for the entire system, and to avoid situations in which a malfunction or failure of such HARATEK products can cause loss of human life, bodily injury or damage to property.
- The HARVATEK products listed in this document are intended for usage in general electronics (computer, personal equipment, office equipment, industrial robotics, domestic, etc...). These products are neither intended nor warranted for usage in equipment that requires extraordinarily high quality and/or reliability.
- In developing your designs, please ensure that HARVATEK products are used within the specified operating ranges as set forth in the most recent HARVATEK products specifications.
- Also, please keep in mind the precautions listed in this document.

Official Product	HT Part No. HT-358FCH	Your Part No.		Data Sheet No.
Tentative Product	*****	*****		HDS-358-K221
Specifications are subject to changes for improvement without advance notice. Proprietary data, drawings, and company confidential all rights reserved.		Mar-7, 2005	Version of 1.0	Page 3/15

Product Specification

	Specification	Material	Quantity
Iv	Red: Rank R ~100-220 mcd Green: Rank R ~100-180 mcd Rank S ~180-285 mcd Blue: Rank Q ~ 50-112 mcd @20mA/ Ta= 25° C		
lambda(λ_D)	Red: 615-635 nm Green: 515-535 nm Blue: 465-480 nm @20mA/ Ta=25° C		
Vf	Red: 1.8-2.3V Green: 2.7-3.7V Blue: 2.7-3.7V @20mA/ Ta=25° C Tolerance±0.05V		
Ir	HT standard		
Resin	Milky Diffused	Epoxy resin	
Carrier tape	According to EIA 481-1A specs	Conductive Black tape	2000pcs per reel
Reel	According to EIA 481-1A specs	Conductive Black	
Label	HT standard	Paper	
Packing bag	220x240mm	Aluminum laminated bag/ no-zipper	One reel one bag
Carton	HT standard	Paper	Non-specified

Others:

ATTENTION: Electricstatic Discharge (ESD) protection



The symbol shown on the page herein to introduce 'Electro-Optical Characteristics'. ESD protection for GaP and AlGaAs based chips is still necessary even though they are safe in low static-electric discharge. Parts built with AlInGaP, GaN, or/and InGaN based chips are

STATIC SENSITIVE devices. ESD protection has to considered and taken in the initial design stage. If manual work/process is needed, please ensure the device is well protected from ESD during all the process.

Official Product	HT Part No. HT-358FCH	Your Part No.		Data Sheet No.
Tentative Product	*****	*****		HDS-358-K221
Specifications are subject to changes for improvement without advance notice. Proprietary data, drawings, and company confidential all rights reserved.		Mar-7, 2005	Version of 1.0	Page 4/15

Label Spec:

HARVATEK		Date: yyyy/mm/dd
CUSTOMER P/N: 		
HARVATEK P/N: 	QTY: PCS 	
LOT NO: 		QC
IV BIN: COLOR BIN: VF:		

■ Customer P/N: To Be Defined

■ Harvatek P/N

H T - 3 5 8 F C H

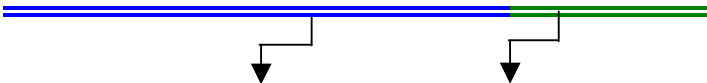

Series Name	Emitting Color
HT-358: 3.2x2.7x1.1mm	Full Color: Red, Green and Blue

■ Lot No.

1 2 3 4 5 6 7 8 9 10
P 1 2 2 3 0 A - D T

Code 1	Code 2	Code 3	Code 4, 5	Code 6, 7	Code 9	Code 10
	Mfg. Year	Mfg. Month	Mfg. Date	Lots	Resin Color	Packaging
Internal Tracing Code	Z: 2000 1: 2001 2: 2002 3: 2003	1: Jan. 2: Feb. 9: Sep. A: Oct. B: Nov. C: Dec.	1~31/ (30)	01~99, A,B,C...	D: Milky White	T: Taped Reel

Official Product	HT Part No. HT-358FCH	Your Part No.	Data Sheet No.
Tentative Product	*****	*****	HDS-358-K221
Specifications are subject to changes for improvement without advance notice. Proprietary data, drawings, and company confidential all rights reserved.		Mar-7, 2005	Version of 1.0 Page 5/15

■ **Iv Bin: Red / Green / Blue**

Color	Bin Code	Spec. Range
Red	R	100-220mcd
Green	R	100-180mcd
	S	180-285mcd
Blue	Q	50-112mcd

■ **Color Bin: Red / Green / Blue**

Color	Bin Code	Spec. Range
Red	-	615-635nm
Green	G	515-525nm
	H	525-535nm
Blue	B	465-470nm
	C	470-475nm
	D	475-480nm

■ **Vf Bin: Red / Green / Blue**

Color	Bin Code	Spec. Range
Red	-	1.8-2.3V
Green	G45	2.7-3.2V
	J15	3.2-3.7V
Blue	G45	2.7-3.2V
	J15	3.2-3.7V

Official Product	HT Part No. HT-358FCH	Your Part No.		Data Sheet No.
Tentative Product	*****	*****		HDS-358-K221
Specifications are subject to changes for improvement without advance notice. Proprietary data, drawings, and company confidential all rights reserved.		Mar-7, 2005	Version of 1.0	Page 6/15

Product Feature

■ Electro-Optical Characteristics

(IF = 20mA, Ta 25°C)

Code for parts	Lighting Color			VF		λ (nm)			I _V (mcd)	
				typ	max	λ _D	λ _P	Δλ	Min	Typ
HT-358FCH	Die1	Ultra Bright Red	USD	1.8	2.3	622	636	17	100	120
	Die2	Green	NG	2.8	3.2	529	522	40	100	160
	Die3	Blue	NB	2.8	3.2	480	477	26	50	80

■ Package Outline Dimension and Recommended Soldering Pattern for Reflow Soldering

Tolerance: +/-0.1

Outline Dim.	Soldering Pattern
	<p style="text-align: center;">Unit: mm</p>
<ol style="list-style-type: none"> Soldering terminal may shift in x, y direction. Common anode. 	

■ Absolute Maximum Ratings

(Ta 25°C)

Series	P _d (mW)	I _F (mA)	I _{FP} (mA)	V _R (V)	I _R (uA)	T _{OP} (°C)	T _{ST} (°C)
USD	46	20	100**	5	<100@ V _R = 5	-30~+80	-40~+85
NB/NG	78	20	80**				

** Condition for I_{FP} is pulse of 1/10 duty and 0.1msec width

Official Product	HT Part No. HT-358FCH	Your Part No.		Data Sheet No.	
Tentative Product	*****	*****		HDS-358-K221	
Specifications are subject to changes for improvement without advance notice. Proprietary data, drawings, and company confidential all rights reserved.		Mar-7, 2005	Version of 1.0	Page 7/15	

Characteristics of HT-358FCH Series

Relative Intensity vs. Forward Current

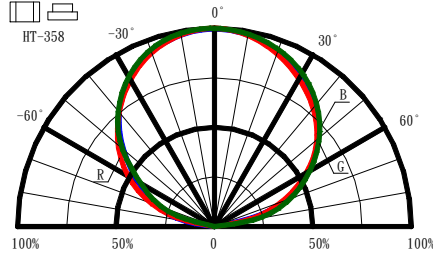
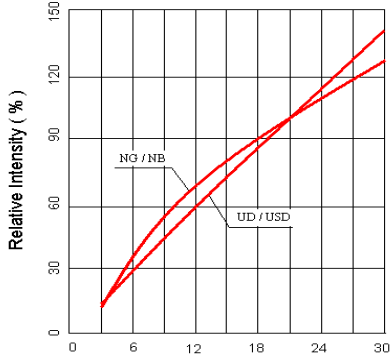

Forward Current vs. Ambient Temperature

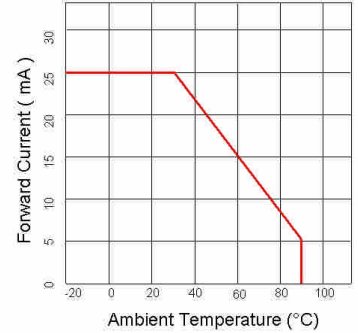

Forward Voltage vs. Forward Current

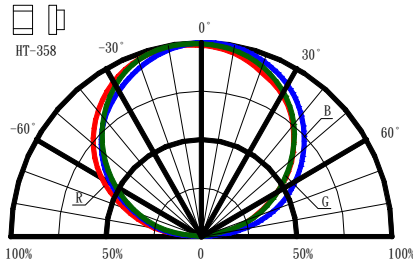
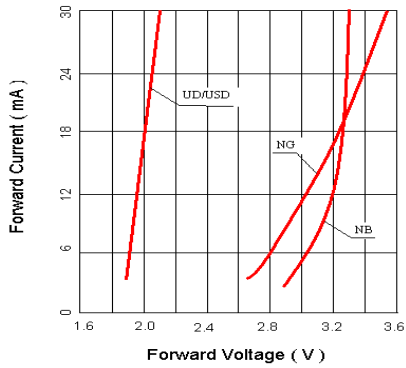

Forward Current vs. Ambient Temperature

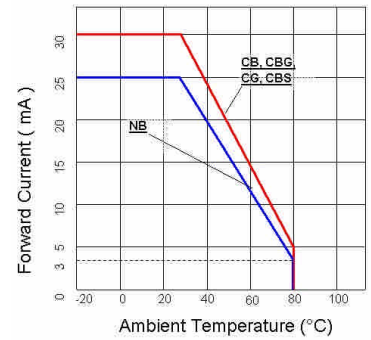

Official Product	HT Part No. HT-358FCH	Your Part No.		Data Sheet No.
Tentative Product	*****	*****		HDS-358-K221
Specifications are subject to changes for improvement without advance notice. Proprietary data, drawings, and company confidential all rights reserved.		Mar-7, 2005	Version of 1.0	Page 8/15

Tape Dimension

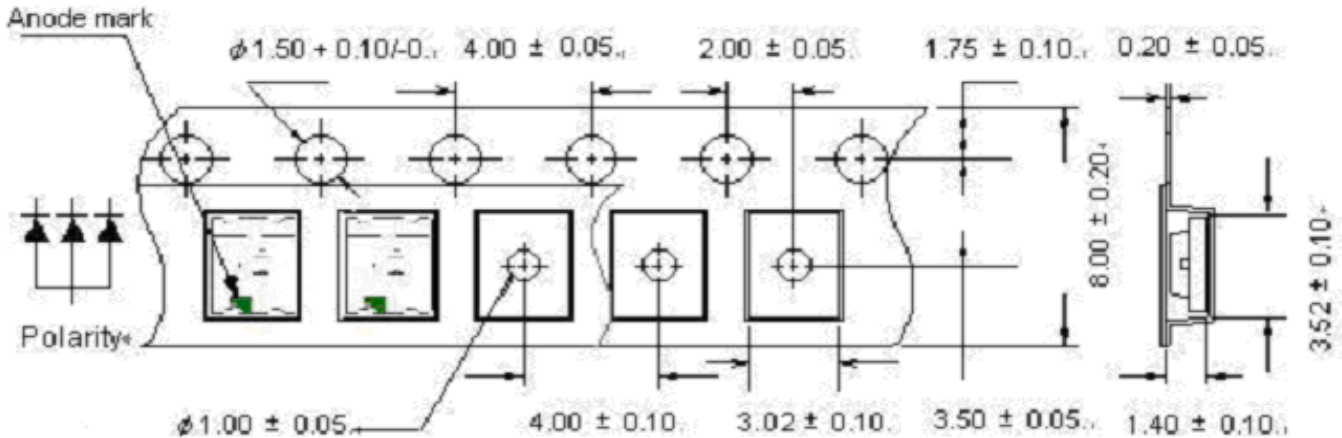

The carrier tape and components loading specifications meet the EIA 481-1A Standard.

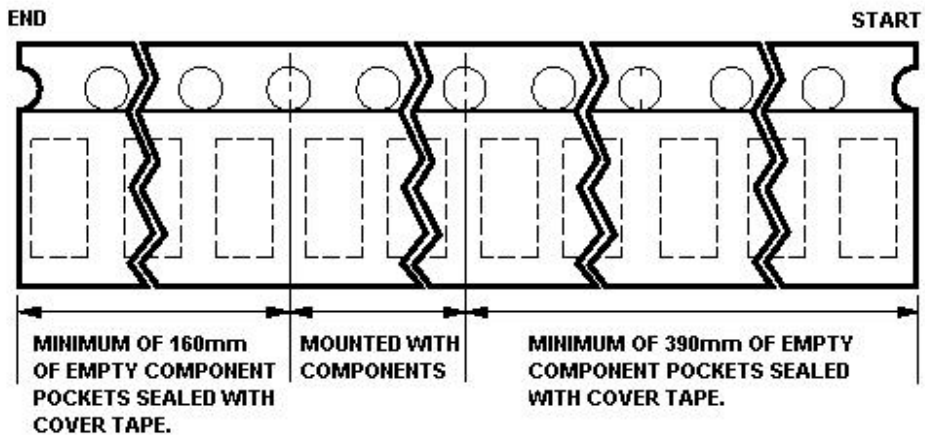

Official Product	HT Part No. HT-358FCH	Your Part No.		Data Sheet No.
Tentative Product	*****	*****		HDS-358-K221
Specifications are subject to changes for improvement without advance notice. Proprietary data, drawings, and company confidential all rights reserved.		Mar-7, 2005	Version of 1.0	Page 9/15

Reel Dimension

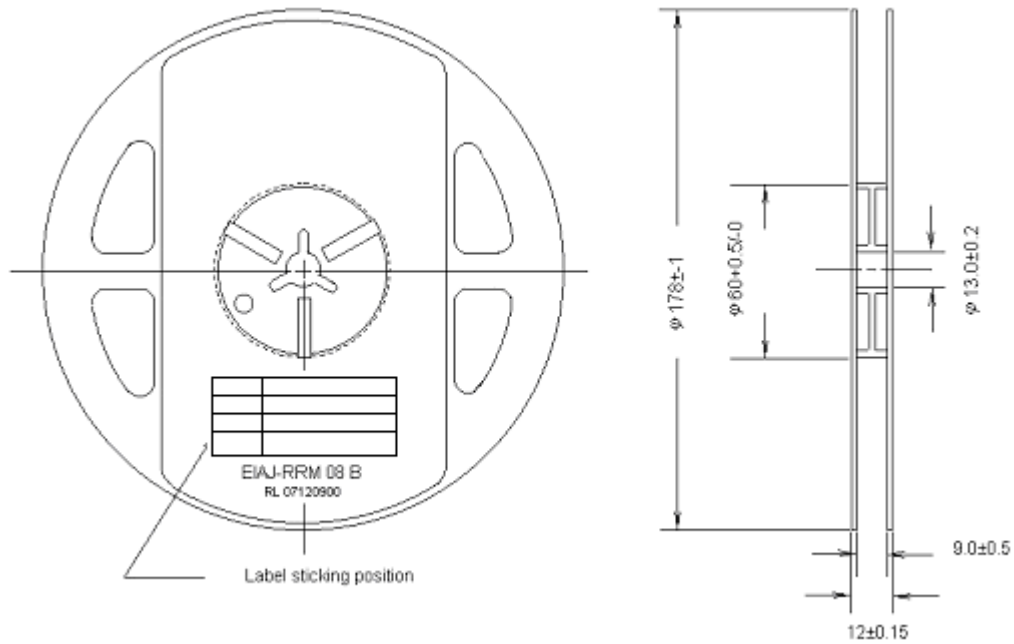

Packing model

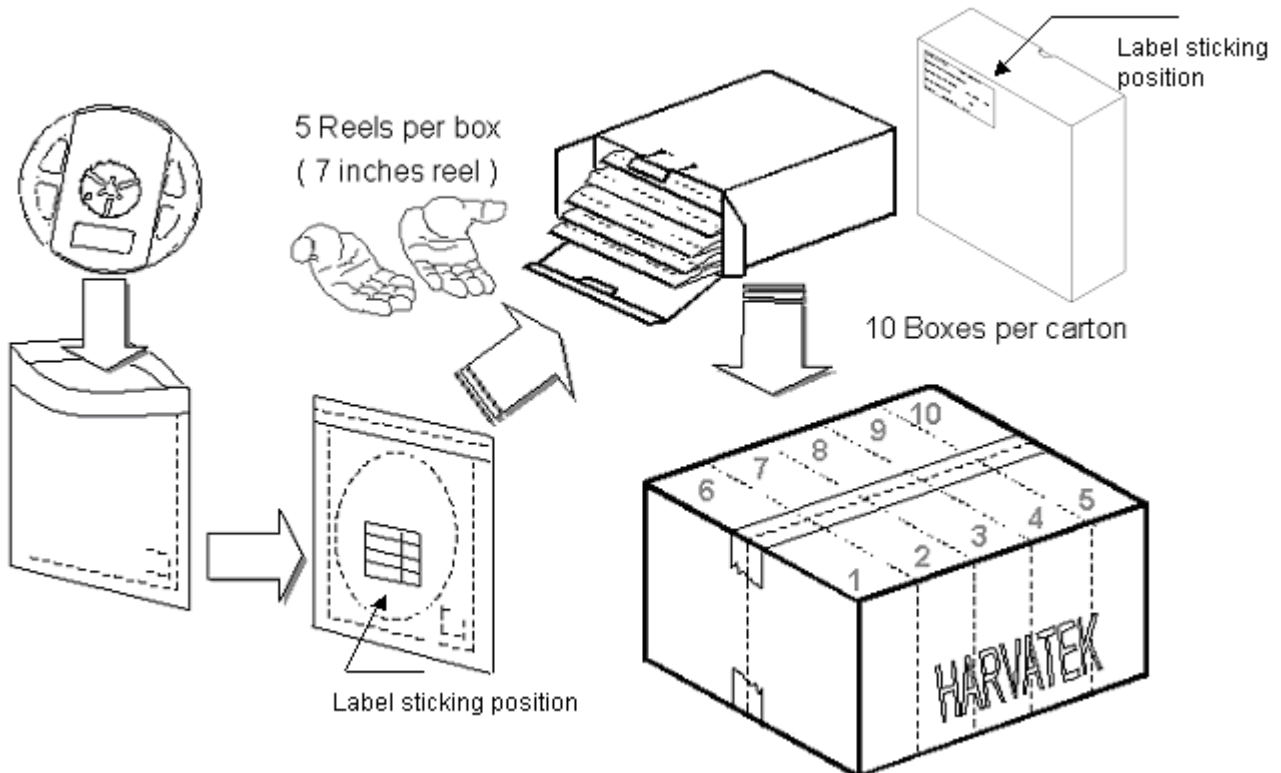

5 boxes per carton is available according to shipping quantity.

Official Product	HT Part No. HT-358FCH	Your Part No.	Data Sheet No.
Tentative Product	*****	*****	HDS-358-K221
Specifications are subject to changes for improvement without advance notice. Proprietary data, drawings, and company confidential all rights reserved.		Mar-7, 2005	Version of 1.0
			Page 10/15

Precaution of Application

Designing 1: Soldering pattern

The dimensions of the recommended soldering pattern may not meet every user. Please confirm and study first before designing the soldering pattern in order to obtain the best performance of soldering.

Designing 2: Circuit layout

Due to the circuit design is not available, assuming the LED are used in parallel and one resistor that is put in series in the circuit, it may not provide an effective current-limiting function to the LEDs due to each LED has own inherent resistance, maybe the resistance each other is different. Different inherent resistance will cause different current; the LED on the different path would be driven at different power. If one LED with a higher resistance, it would be dimmer than the others.

To solve this situation, a suitable resistor is put in series with each LED to limit the current disparity through the LED will be very useful.

Designing 3: Electric Static Discharge (ESD) protection



ESD protection for GaP and AlGaAs chips are still necessary even though they are safety in low static-electric discharge. Material in AlInGaP, GaN, or/and InGaN chips are **STATIC SENSITIVE device**. ESD protection shall be considered and taken in the initial design stage.

If manual work/process is needed, please ensure the device is well protective from ESD within all the process.

Designing 4: Max Rating

Any application should refer to the specifications of absolute maximum ratings.

Dry Pack

Any SMD optical device, like this chip LED, is **MOISTURE SENSITIVE device**. Avoid absorbing moisture at any time during transportation or storage. Every reel will be packaged in the moisture barrier anti-static bag (Specific bag material will depend upon customers' requirement or option). And the bag is well sealed before shipment.

The package is the following:

Official Product	HT Part No. HT-358FCH	Your Part No.		Data Sheet No.
Tentative Product	*****	*****		HDS-358-K221
Specifications are subject to changes for improvement without advance notice. Proprietary data, drawings, and company confidential all rights reserved.		Mar-7, 2005	Version of 1.0	Page 11/15

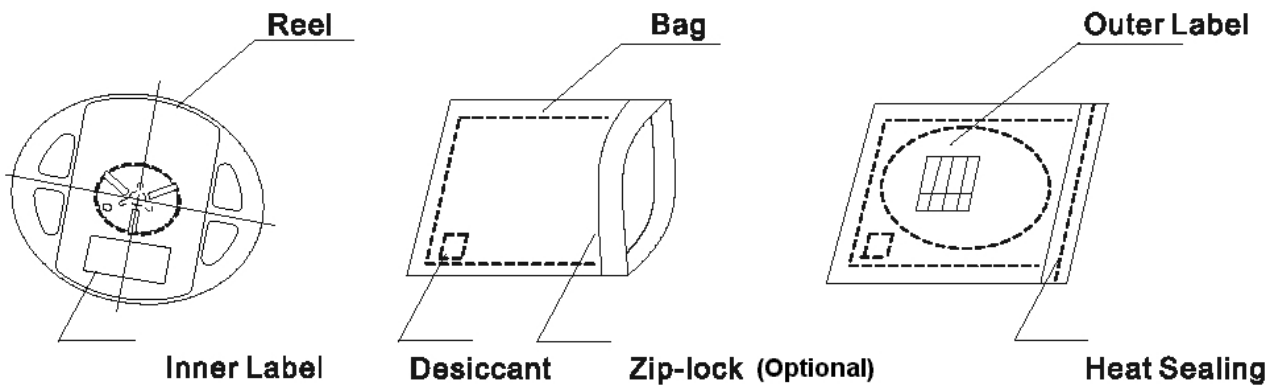

Storage

It's recommended to store the products in the following conditions:

Humidity: 60 %RH Max.

Temperature: 5 °C ~30 °C (41°F~86 °F)

- 1 Shelf life in sealed bag: 12 month at 40°C and $90\% \text{RH}$. (Base on aluminum laminated moisture barrier bag.)
- 2 After the bag is opened, devices that will be subjected to infrared reflow, vapor-phase reflow, or equivalent processing must be:
 - 2.1 Mounted within 72 hours at factory conditions of $\leq 30^{\circ}\text{C} / 60\% \text{RH}$, or
 - 2.2 Stored at $\leq 20\% \text{RH}$ with zip-lock sealed.

Baking

It's recommended to bake before soldering when the pack is unsealed after 15 days. The conditions are as followings:

- a) $60 \pm 3^{\circ}\text{C} \times (12 \sim 24 \text{hrs})$ and $5\% \text{RH}$, taped reel type
- b) $100 \pm 3^{\circ}\text{C} \times (45 \text{min} \sim 1 \text{hr})$, bulk type
- c) $130 \pm 3^{\circ}\text{C} \times (15 \sim 30 \text{min})$, bulk type

Official Product	HT Part No. HT-358FCH	Your Part No.		Data Sheet No.
Tentative Product	*****	*****		HDS-358-K221
Specifications are subject to changes for improvement without advance notice. Proprietary data, drawings, and company confidential all rights reserved.		Mar-7, 2005	Version of 1.0	Page 12/15

Soldering

Manual soldering (We do not recommend this method strongly.)

- ◆ Soldering tin material: tin 6/4 alloy or contained Ag.
- ◆ To prevent cracking, please bake before manual soldering.
- ◆ Keep the temperature on the edge of iron at $300^{\circ}\text{C} \pm 5^{\circ}\text{C}$ max. (25W) and apply for 3 seconds. If the temperature become higher, apply in a shorter time (1 sec. per 10°C)
- ◆ In manual soldering, take care not to damage the package especially terminal or resin. (Do not give stress to the product when soldering)
- ◆ Do not use again if you remove the soldered product.
- ◆ It is recommended using an iron with a temperature control.

Re-flow Soldering

- ◆ Recommend tin glue specifications:
Melting temperature: $178\sim 192^{\circ}\text{C}$
- ◆ Never take next process until the component is cooled down to room temperature after re-flow.
- ◆ The recommended re-flow soldering profile (measuring on the surface of the LED resin) is following:

Lead Solder profile

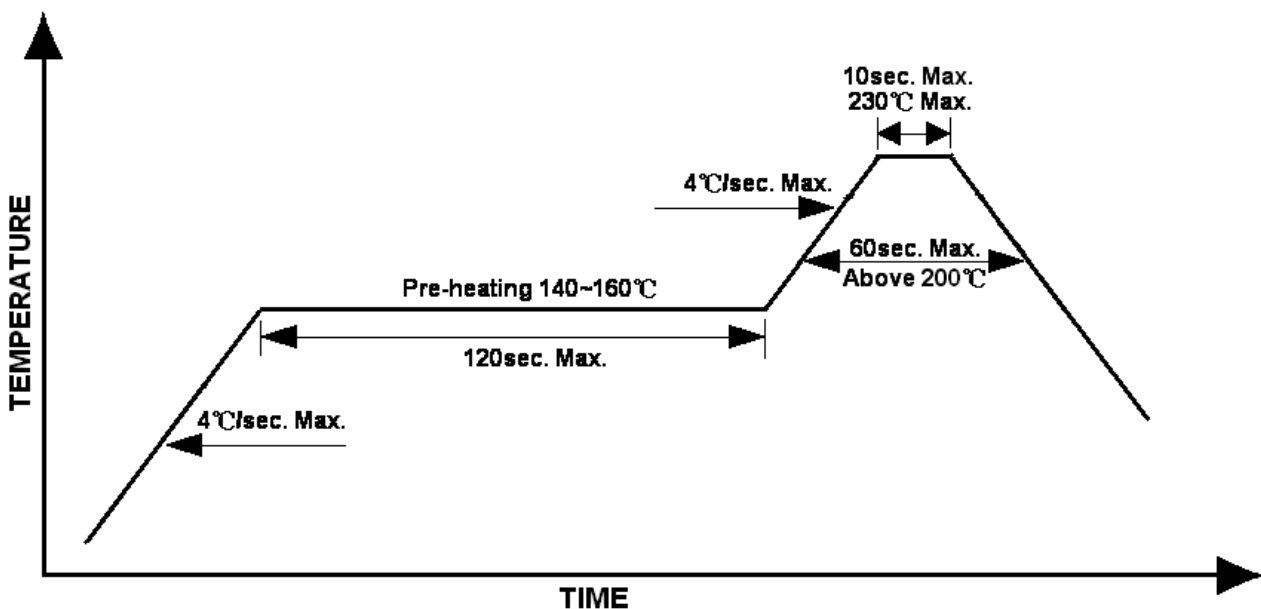

Official Product	HT Part No. HT-358FCH	Your Part No.		Data Sheet No.
Tentative Product	*****	*****		HDS-358-K221
Specifications are subject to changes for improvement without advance notice. Proprietary data, drawings, and company confidential all rights reserved.		Mar-7, 2005	Version of 1.0	Page 13/15

Lead-free Solder profile

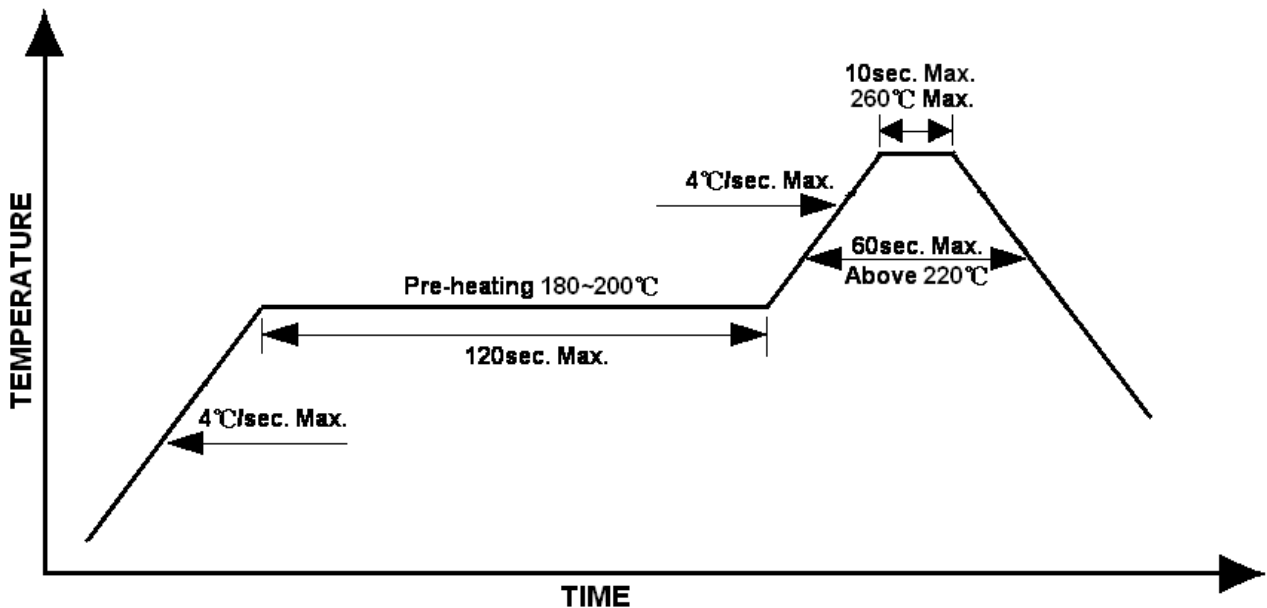

Rework

- ◆ Customer must finish rework within 5 sec. under 260 °C.
- ◆ The head of iron cannot touch copper foil.
- ◆ Twin-head type is preferred.

Cleaning

- ◆ The conditions of cleaning after soldering:
- ◆ An alcohol-based solvent such as Isopropyl Alcohol (IPA) is recommended.
- ◆ Temperature×Time: <50 °C×30sec, or <30 °C×3min
- ◆ Ultra sonic cleaning: < 15W/ bath; Bath volume: 1liter max.
- ◆ Curing: 100 °C max, <3min

Cautions of Pick and Place

- ◆ It should be avoided to load stress on the resin during high temperature.
- ◆ Avoid rubbing or scraping the resin by any object.
- ◆ Electric-static may cause damage to the component. Please confirm that the equipment is grounding well. Using an ionizer fan is recommended.

Official Product	HT Part No. HT-358FCH	Your Part No.		Data Sheet No.
Tentative Product	*****	*****		HDS-358-K221
Specifications are subject to changes for improvement without advance notice. Proprietary data, drawings, and company confidential all rights reserved.		Mar-7, 2005	Version of 1.0	Page 14/15

Reliability Test

Item	Frequency/ lots/ samples/ failures	Standards Reference	Conditions
Precondition	For all reliability monitoring tests according to JEDEC Level 2	J-STD-020	1.) Baking at 85°C for 24hrs 2.) Moisture storage at 85°C/ 60% R.H. for 168hrs
Solderability	1Q/ 1/ 22/ 0	JESD22-B102-B And CNS-5068	Accelerated aging 155°C/ 24hrs Tinning speed: 2.5±0.5cm/s Tinning: A: 215°C/ 3±1s or B: 260°C/ 10±1s
Resistance to soldering heat		CNS-5067	Dipping soldering terminal only Soldering bath temperature A: 260±5°C; 10±1s B: 350±10°C; 3±0.5s
Operating life test	1Q/ 1/ 40/ 0	CNS-11829	1.) Precondition: 85°C baking for 24hrs 85°C/ 60%R.H. for 168hrs 2.) T _{amb} 25°C; I _F =20mA; duration 1000hrs
High humidity, high temperature bias	1Q/ 1/ 45/ 0	JESD-A101-B	T _{amb} : 85°C Humidity: 85% R.H., I _F =5mA Duration: 1000hrs
High temperature bias	1Q/ 1/ 20/ 0	HT specs.	T _{amb} : 55°C I _F =20mA Duration: 1000hrs
Pulse life test	1Q/ 1/ 40/ 0		T _{amb} 25°C, I _F =20mA, I _p =100mA, Duty cycle=0.125 (tp=125 μs, T=1sec) Duration 500hrs)
Temperature cycle	1Q/ 1/ 76/ 0	JESD-A104-A IEC 68-2-14, Nb	A cycle: -40 degree C 15min; +85 degree C 15min Thermal steady within 5 min.. 300 cycles 2 chamber/ Air-to-air type
High humidity storage test	1Q/ 1/ 40/ 0	CNS-6117	60±3°C 90±5/-10% R.H. for 500hrs
High temperature storage test	1Q/ 1/ 40/ 0	CNS-554	100±10°C for 500hrs
Low temperature storage test	1Q/ 1/ 40/ 0	CNS-6118	-40±5°C for 500hrs

Official Product	HT Part No. HT-358FCH	Your Part No.		Data Sheet No.
Tentative Product	*****	*****		HDS-358-K221
Specifications are subject to changes for improvement without advance notice. Proprietary data, drawings, and company confidential all rights reserved.		Mar-7, 2005	Version of 1.0	Page 15/15