

Features

- 2.3 inch digit height.
- Low current operation.
- Excellent character appearance.
- High light output.
- Easy mounting on P.C. boards or sockets.
- Multicolor available.
- Mechanically rugged.
- Standard : gray face, white segment.
- RoHS compliant.

Description

The Green source color devices are made with AlGaInP on GaAs substrate Light Emitting Diode.

Package Dimensions & Internal Circuit Diagram

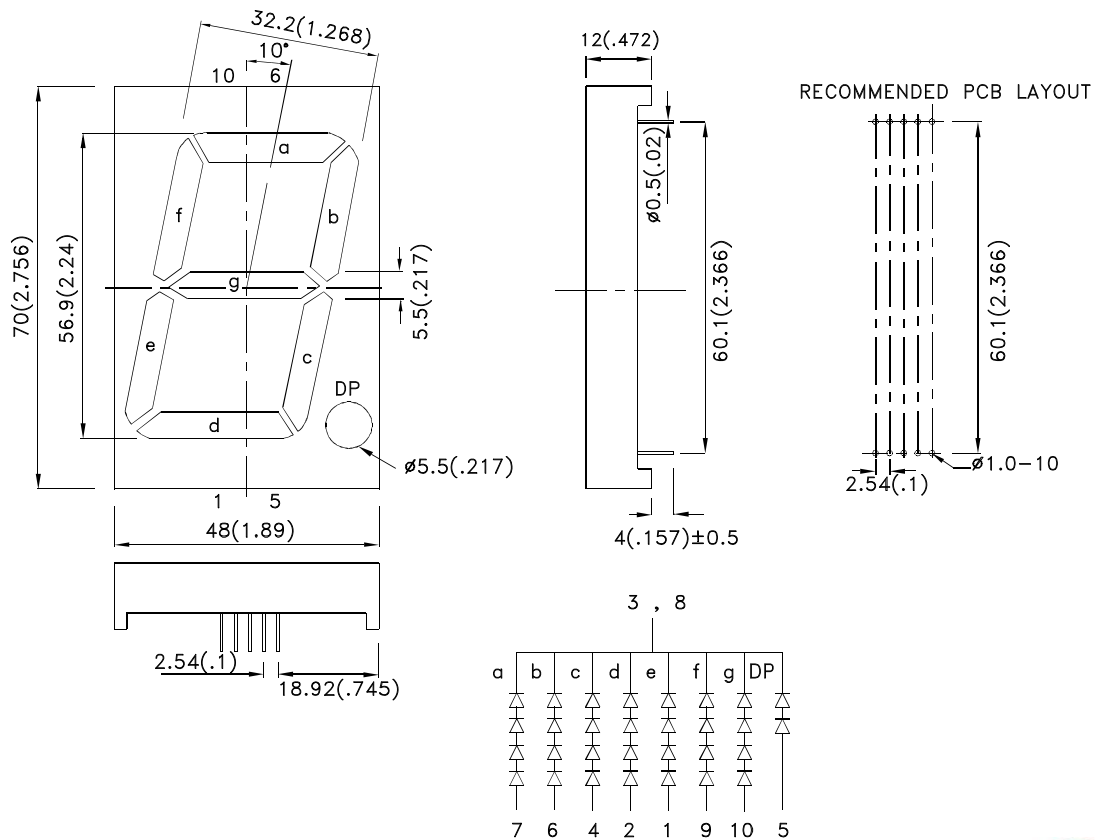

Notes:

1. All dimensions are in millimeters (inches), Tolerance is $\pm 0.25 (0.01)$ unless otherwise noted.
2. The specifications, characteristics and technical data described in the datasheet are subject to change without prior notice.



Selection Guide

Part No.	Dice	Lens Type	Iv (ucd) [1] @ 10mA		Description
			Min.	Typ.	
SC23-12CGKWA	Green (AlGaInP)	WHITE DIFFUSED	44000	200300	Common Cathode. Rt. Hand Decimal

Note:

1. Luminous intensity/ luminous Flux: +/-15%.

Electrical / Optical Characteristics at TA=25°C

Symbol	Parameter	Device	Typ.	Max.	Units	Test Conditions
λ peak	Peak Wavelength	Green	574		nm	IF=20mA
λ D [1]	Dominant Wavelength	Green	570		nm	IF=20mA
$\Delta\lambda$ 1/2	Spectral Line Half-width	Green	20		nm	IF=20mA
C	Capacitance	Green	15		pF	VF=0V;f=1MHz
VF [2]	Forward Voltage Per Segment or (DP)	Green	8.4 (4.2)	10.0 (5.0)	V	IF=20mA
IR	Reverse Current Per Segment or (DP)	Green		10 (10)	uA	VR=20V (VR=10V)

Notes:

1. Wavelength: +/-1nm.
2. Forward Voltage: +/-0.1V.

Absolute Maximum Ratings at TA=25°C

Parameter	Green	Units
Power dissipation Per Segment or (DP)	300 (150)	mW
DC Forward Current Per Segment or (DP)	30 (30)	mA
Peak Forward Current [1] Per Segment or (DP)	150 (150)	mA
Reverse Voltage Per Segment or (DP)	20 (10)	V
Operating/Storage Temperature	-40°C To +85°C	
Lead Solder Temperature [2]	260°C For 3 ~5 Seconds	

Notes:

1. 1/10 Duty Cycle, 0.1ms Pulse Width.
2. 2mm below package base.

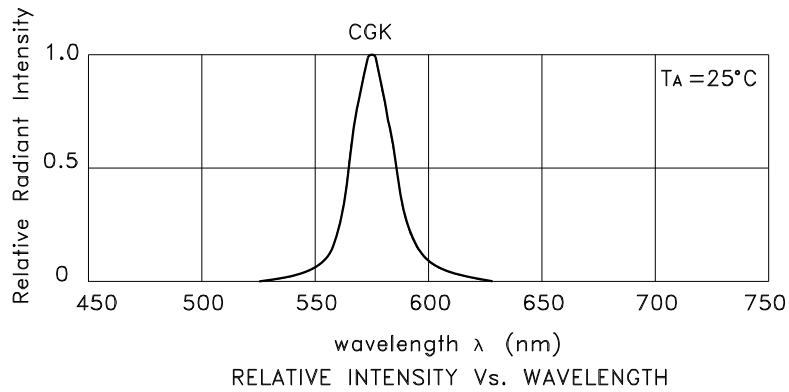

Green

SC23-12CGKWA

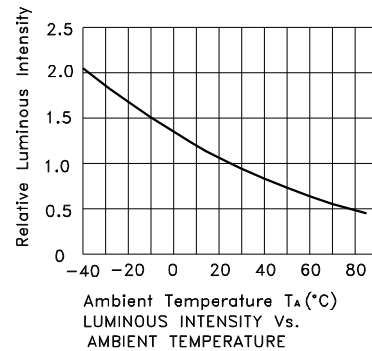
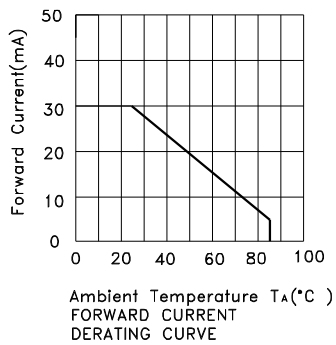
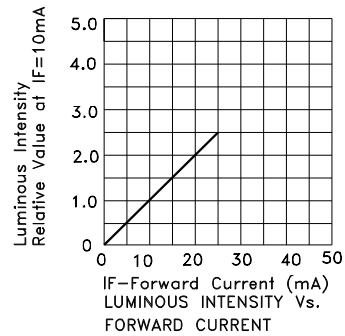
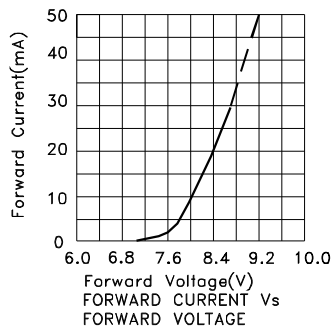

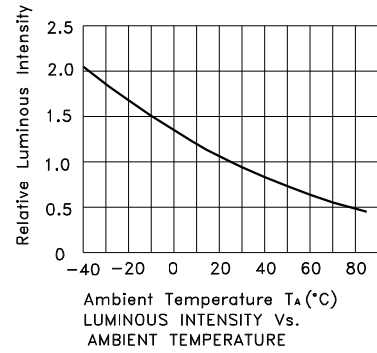
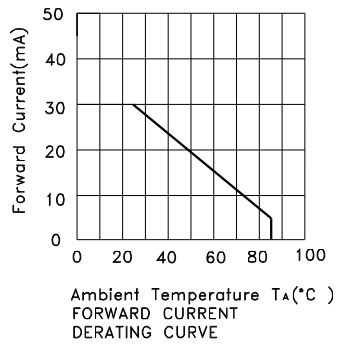
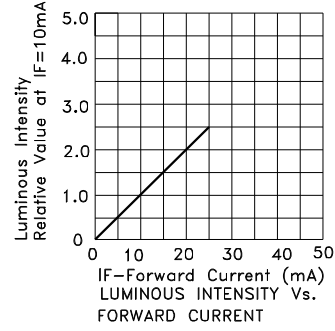
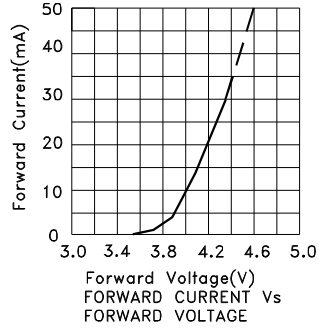

PACKING & LABEL SPECIFICATIONS

SC23-12CGKWA

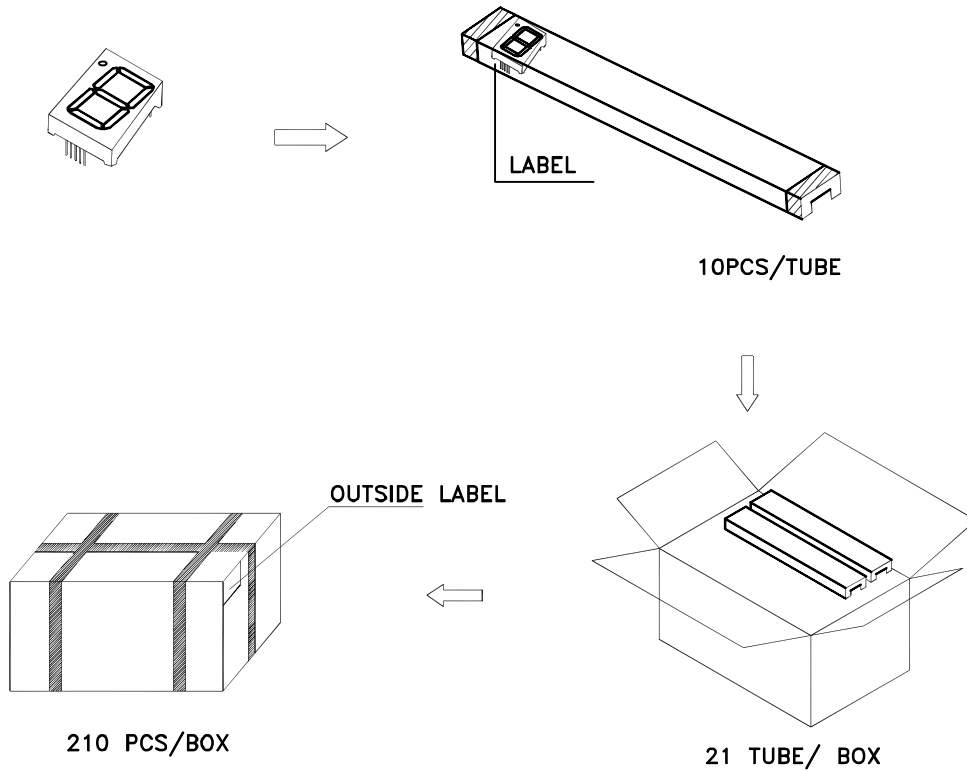

Inside LABEL Paste On The IC-tube

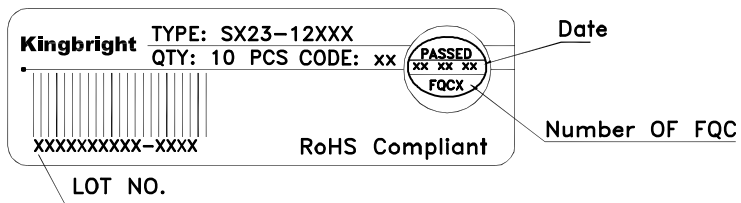

Outside LABEL Paste On The Box

