



ATTENTION
OBSERVE PRECAUTIONS
FOR HANDLING
ELECTROSTATIC
DISCHARGE
SENSITIVE
DEVICES

WP7676CPBC/H

BLUE

Features

- SUPER FLUX OUTPUT.
- DESIGN FOR HIGH CURRENT OPERATION.
- OUTSTANDING MATERIAL EFFICIENCY.
- RELIABLE AND RUGGED.
- RoHS COMPLIANT.
- UV RATED EPOXY.

Description

The Blue source color devices are made with InGaN on SiC Light Emitting Diode.

Static electricity and surge damage the LEDs.

It is recommended to use a wrist band or anti-electrostatic glove when handling the LEDs.

All devices, equipment and machinery must be electrically grounded.

Package Dimensions

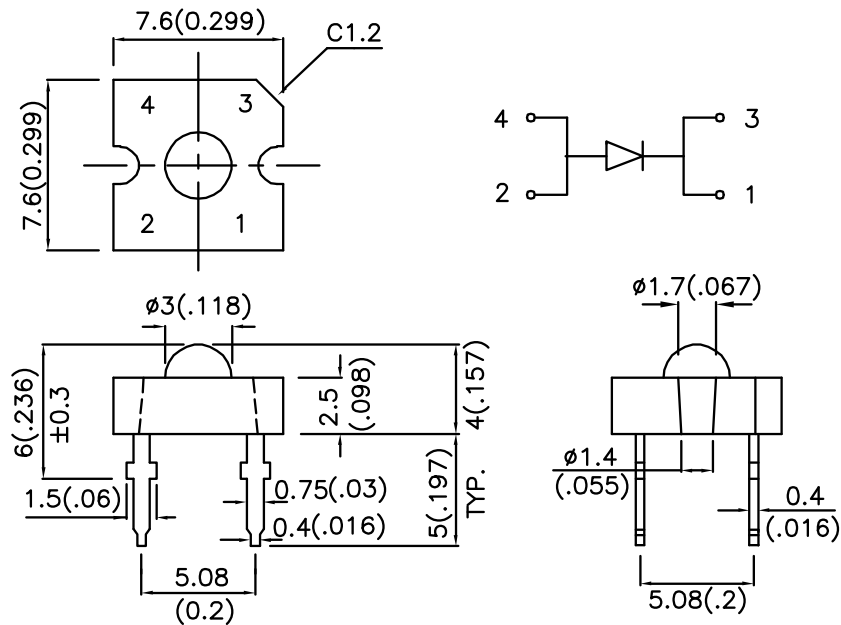

Notes:

1. All dimensions are in millimeters (inches).
2. Tolerance is $\pm 0.25(0.01)$ unless otherwise noted.
3. Lead spacing is measured where the leads emerge from the package.
4. Specifications are subject to change without notice.

Selection Guide

Part No.	Dice	Lens Type	Iv (mcd) @ 20mA *70mA		Viewing Angle
			Min.	Typ.	2 θ 1/2
WP7676CPBC/H	BLUE (InGaN)	WATER CLEAR	380	800	70°
			*1200	*1900	70°

Notes:

1. θ1/2 is the angle from optical centerline where the luminous intensity is 1/2 the optical centerline value.
2. * Luminous intensity with asterisk is measured at 70mA under 40ms pulse width.
3. Drive current between 10mA and 30mA are recommended for long term performance.
4. Operation at current below 10mA is not recommended.

Electrical / Optical Characteristics at TA=25°C

Symbol	Parameter	Device	Typ.	Max.	Units	Test Conditions
λ _{peak}	Peak Wavelength	Blue	467		nm	I _F =20mA
λ _D	Dominant Wavelength	Blue	470		nm	I _F =20mA
Δλ _{1/2}	Spectral Line Half-width	Blue	30		nm	I _F =20mA
C	Capacitance	Blue	110		pF	V _F =0V;f=1MHz
V _F	Forward Voltage	Blue	3.7	4.3	V	I _F =20mA
I _R	Reverse Current	Blue		10	uA	V _R = 5V

Absolute Maximum Ratings at TA=25°C

Parameter	Blue	Units
Power dissipation	108	mW
DC Forward Current	30	mA
Peak Forward Current [1]	100	mA
Reverse Voltage	5	V
Operating/Storage Temperature	-40°C To +85°C	
Lead Solder Temperature [2]	260°C For 3 Seconds	
Lead Solder Temperature [3]	260°C For 5 Seconds	

Notes:

1. 1/10 Duty Cycle, 0.1ms Pulse Width.
2. 2mm below package base.
3. 5mm below package base.

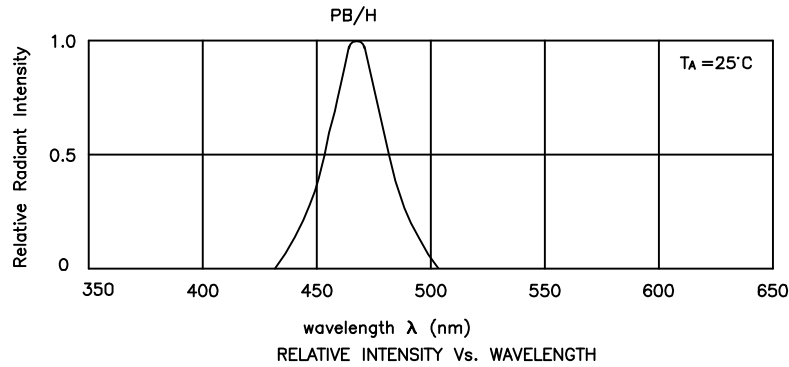

Blue

WP7676CPBC/H

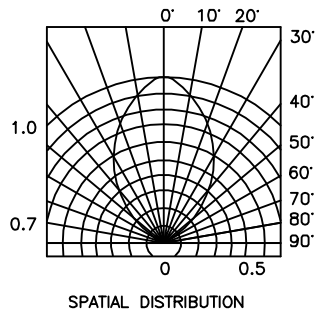
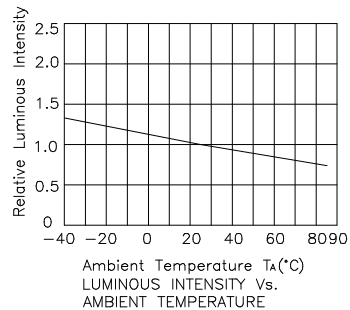
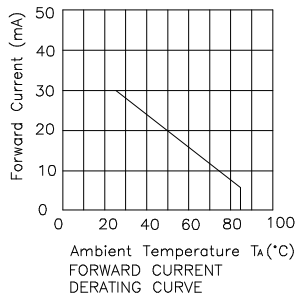
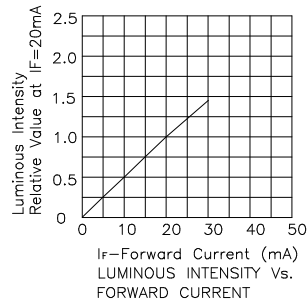
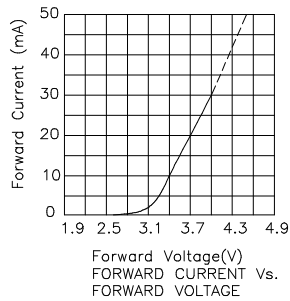

Remarks:

If special sorting is required (e.g. binning based on forward voltage, luminous intensity, or wavelength), the typical accuracy of the sorting process is as follows:

1. Wavelength: +/-1nm
2. Luminous Intensity: +/-15%
3. Forward Voltage: +/-0.1V

Note: Accuracy may depend on the sorting parameters.