

PRELIMINARY SPEC

Part Number: WP7678C2ZGC/E



Technical Data



ATTENTION
OBSERVE PRECAUTIONS
FOR HANDLING
ELECTROSTATIC
DISCHARGE
SENSITIVE
DEVICES

Description

Static electricity and surge damage the LEDs. It is recommended to use a wrist band or anti-electrostatic glove when handling the LEDs. All devices, equipment and machinery must be electrically grounded.

Features:

- *High luminance output.
- *Design for high current operation.
- *Uniform color.
- *Low power consumption.
- *Low thermal resistance.
- *Low profile.
- *Packaged in tubes for use with automatic insertion equipment.
- *Soldering methods: wave soldering.
- *RoHS compliant.

Benefits:

- *Outstanding Material Efficiency.
- *Electricity savings.
- *Maintenance savings.
- *Reliable and Rugged.

Typical Applications:

- *Automotive Exterior Lighting.
- *Electronic Signs and Signals.
- *Specialty Lighting.



Outline Drawings

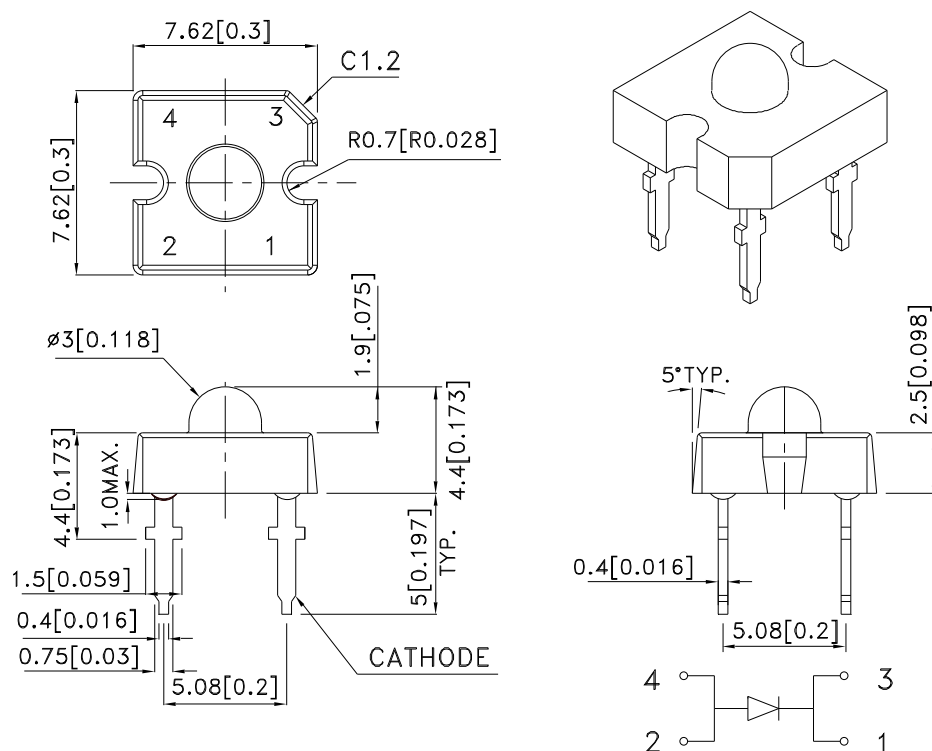

Notes:

1. All dimensions are in millimeters (inches).
2. Tolerance is $\pm 0.25(0.01")$ unless otherwise noted.
3. Lead spacing is measured where the leads emerge from the package.
4. Specifications are subject to change without notice.

Absolute Maximum Ratings at $T_A=25^\circ\text{C}$

PARAMETER	ZG/E	UNITS
DC Forward Current	30	mA
Power dissipation	123	mW
Reverse Voltage	5	V
Operating Temperature	-40 To +85	$^\circ\text{C}$
Storage Temperature	-55 To +85	$^\circ\text{C}$
Lead Solder Temperature[1]	260 $^\circ\text{C}$ For 5 Seconds	

1.1.5mm[0.06inch]below seating plane.
NO Reflow soldering .

Selection Guide

Part No.	LED COLOR	Iv(cd)[1] @30mA		Φv(lm)[1] @30mA	Viewing Angle[2] 2θ1/2
		Min.	Typ.	Typ.	Typ.
WP7678C2ZGC/E	Green (InGaN)	4.7	8.5	6.9	40°

Notes:

- Luminous intensity is measured with an integrating sphere after the device has stabilized; Luminous Intensity / luminous flux: +/-15%.
- θ1/2 is the angle from optical centerline where the luminous intensity is 1/2 of the optical peak value.

Optical Characteristics at TA=25°C If=30mA Rθj-a=200°C/W

DEVICE TYPE	PEAK WAVELENGTH λPEAK (nm) TYP.	DOMINANT[1] WAVELENGTH λDOM (nm) TYP.	SPECTRAL LINE WAVELENGTH Δλ1/2(nm) TYP.
ZG/E	520	525	35

Note:

- The dominant wavelength is derived from the CIE Chromaticity Diagram and represents the perceived color of the device; Wavelength: +/-1nm.

Electrical Characteristics at TA=25°C

DEVICE TYPE	FORWARD VOLTAGE [1] VF (VOLTS) @ If=30mA		REVERSE CURRENT Ir (uA) @ VR=5V	CAPACITANCE C (pF) @ VF=0V F=1MHZ	THERMAL RESISTANCE Rθj -pin °C/W
	TYP.	MAX.	MAX.	TYP.	TYP.
ZG/E	3.3	4.1	10	100	150

Note:

- Forward Voltage: +/-0.1V.

Figures

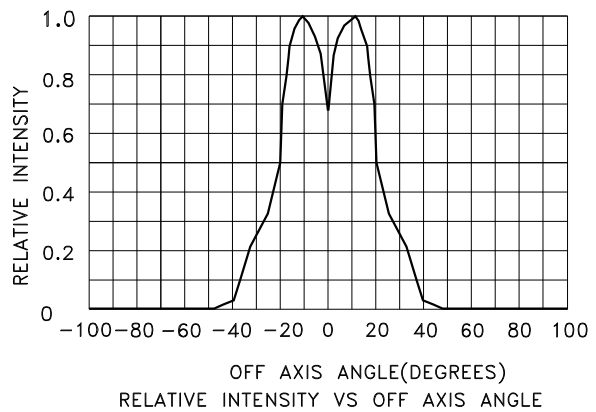
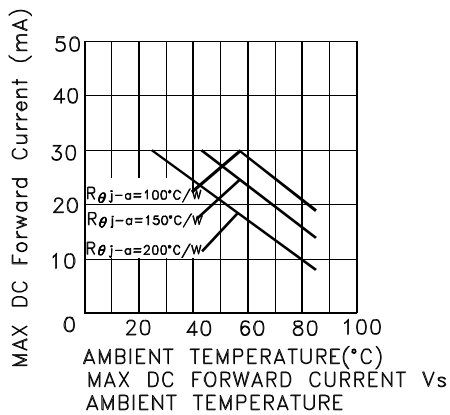
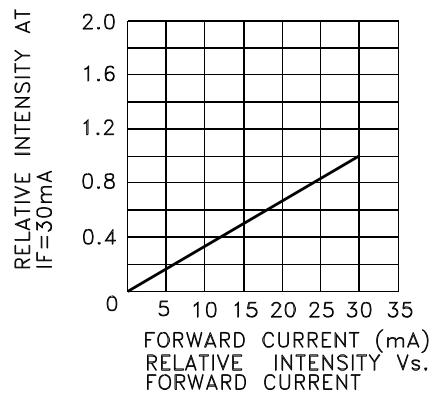
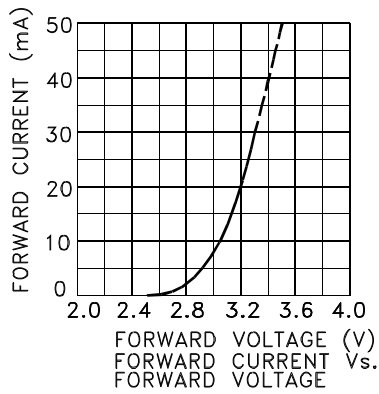
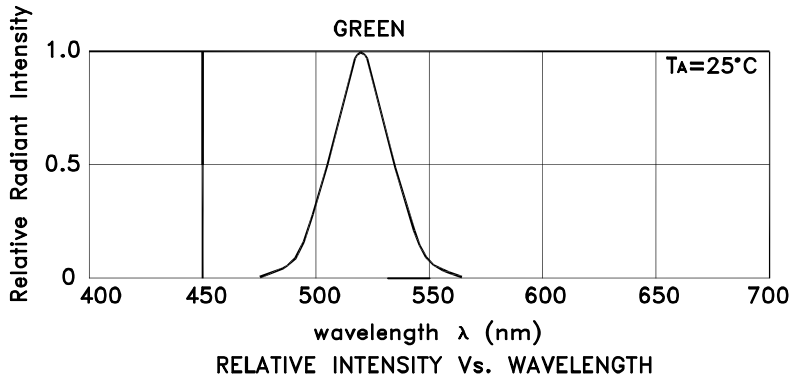

PACKING & LABEL SPECIFICATIONS

WP7678C2ZGC/E

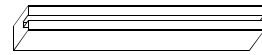
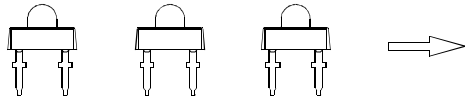

75PCS / IC TUBE(520x8.3x15mm)

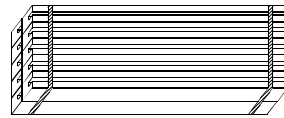

750pcs / 10pcs IC TUBE

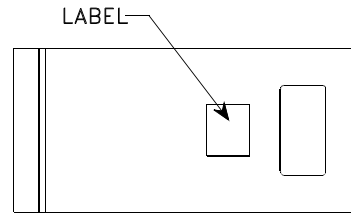

10pcs IC TUBE / Bag

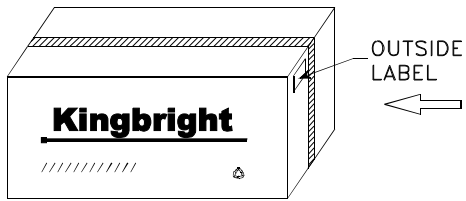

7.5K / 6# BOX

<h1>Kingbright</h1>	
P/NO: WP7678C2XXX	
QTY: 750 pcs	Q.C. Q C XX XX XXXX PASSED
S/N: XXXX	
CODE: XXX	
LOT NO:	
 xxxxxxxxxxxxxxxxxxxxxxxxxxxx	
RoHS Compliant	