

FEATURES

- * 1.85 INCH (47 mm) MATRIX HEIGHT.
- * LOW POWER REQUIREMENT.
- * SINGLE PLANE, WIDE VIEWING ANGLE.
- * 5× 8 ARRAY WITH X-Y SELECT.
- * COMPATIBLE WITH ASCII AND EBCDIC CODES.
- * STACKABLE VERTICALLY AND HORIZONTALLY.
- * EASY MOUNTING ON P.C. BOARD.
- * CATEGORIZED FOR LUMINOUS INTENSITY.

DESCRIPTION

The LTP-18388A-02 is a 1.85 inch (47 mm) matrix height 8× 8 dot matrix display. This device utilizes high efficiency red & green LED chips. The high efficiency red chips are made from GaAsP on a transparent GaP substrate, and the green chips are made from GaP on a transparent GaP substrate. This device has a black face and white dots.

The product is binned by luminous intensity and dominant wavelength in the red mode of operation.

DEVICE

PART NO.	DESCRIPTION
MULTI-COLOR	Cathode Column
LTP-18388A-02	Anode Row

PACKAGE DIMENSIONS

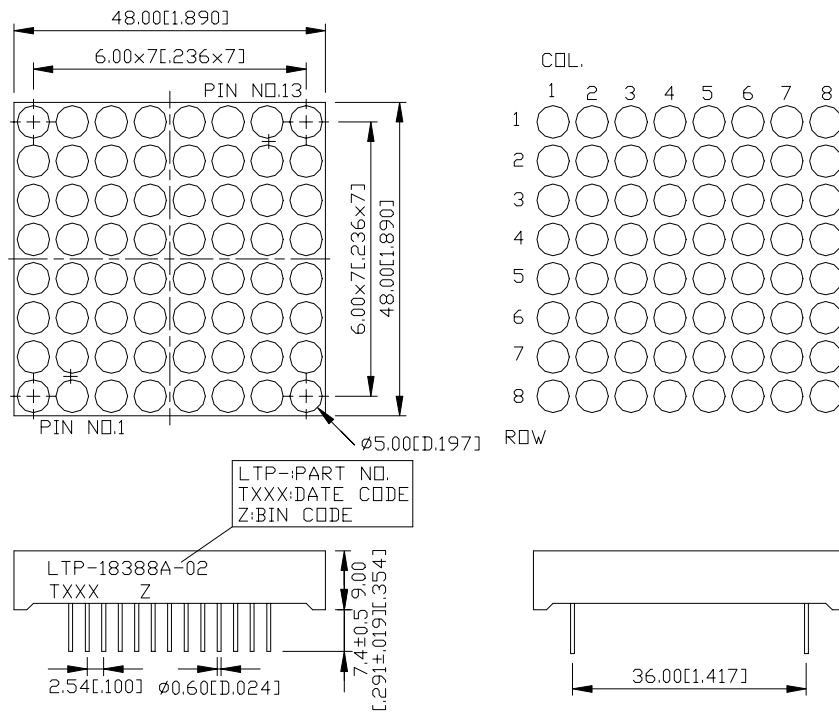

NOTES: All dimensions are in millimeters. Tolerance is ± 0.25 mm (0.01") unless otherwise noted.

INTERNAL CIRCUIT DIAGRAM

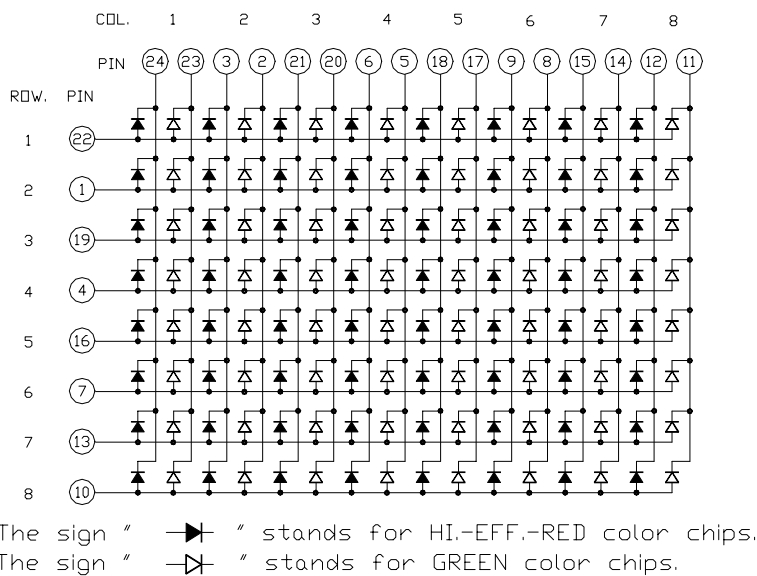

PIN CONNECTION

No.	CONNECTION	No.	CONNECTION
1	ANODE ROW 2	13	ANODE ROW 7
2	CATHODE COLUMN 2 GREEN	14	CATHODE COLUMN 7 GREEN
3	CATHODE COLUMN 2 HI-EFF RED	15	CATHODE COLUMN 7 HI-EFF RED
4	ANODE ROW 4	16	ANODE ROW 5
5	CATHODE COULMN 4 GREEN	17	CATHODE COLUMN 5 GREEN
6	CATHODE COLUMN 4 HI-EFF RED	18	CATHODE COLUMN 5 HI-EFF RED
7	ANODE ROW 6	19	ANODE ROW 3
8	CATHODE COLUMN 6 GREEN	20	CATHODE COLUMN 3 GREEN
9	CATHODE COLUMN 6 HI-EFF RED	21	CATHODE COLUMN 3 HI-EFF RED
10	ANODE ROW 8	22	ANODE ROW 1
11	CATHODE COLUMN 8 GREEN	23	CATHODE COLUMN 1 GREEN
12	CATHODE COLUMN 8 HI-EFF RED	24	CATHODE COLUMN 1 HI-EFF RED

ABSOLUTE MAXIMUM RATINGS AT Ta=25°C

PARAMETER	HI-EFF RED	GREEN	UNIT
Power Dissipation Per Dot	36	36	mW
Peak Forward Current Per Dot (1/10 Duty Cycle, 0.1ms Pulse Width)	100	100	mA
Continuous Forward Current Per Dot	13	13	mA
Derating Linear From 25°C Per Dot	0.17	0.17	mA/°C
Reverse Voltage Per Dot	5	5	V
Operating Temperature Range	-35°C to +85°C		
Storage Temperature Range	-35°C to +85°C		
Solder Temperature: max. 260°C for max 3sec at 1.6mm below seating plane			

ELECTRICAL/OPTICAL CHARACTERISTICS AT Ta=25°C**HI.-EFF. RED**

PARAMETER	SYMBOL	MIN.	TYP.	MAX.	UNIT	TEST CONDITION
Average Luminous Intensity	I _v	1780	4800		μcd	I _p = 80mA ,1/16 Duty
Peak Emission Wavelength	λ _p		650		nm	I _F =20 mA
Spectral Line Half-Width	Δλ		40		nm	I _F =20 mA
Dominant Wavelength	λ _d		630		nm	I _F =20 mA
Forward Voltage any Dot	V _F		2.0	2.6	V	I _F =20 mA
			2.6	3.4	V	I _F =80 mA
Reverse Current any Dot	I _R			100	μA	V _R =5 V
Luminous Intensity Matching Ratio	I _v -m			2:1		I _F =10 mA

GREEN

PARAMETER	SYMBOL	MIN.	TYP.	MAX.	UNIT	TEST CONDITION
Average Luminous Intensity	I _v	1780	4800		μcd	I _p =80 mA ,1/16 Duty
Peak Emission Wavelength	λ _p		565		nm	I _F =20 mA
Spectral Line Half-Width	Δλ		30		nm	I _F =20 mA
Dominant Wavelength	λ _d		569		nm	I _F =20 mA
Forward Voltage any Dot	V _F		2.1	2.6	V	I _F =20 mA
			3.0	3.7	V	I _F =80 mA
Reverse Current any Dot	I _R			100	μA	V _R =5 V
Luminous Intensity Matching Ratio	I _v -m			2:1		I _F =10 mA

Note: Luminous intensity is measured with a light sensor and filter combination that approximates the CIE (Commision Internationale De L'Eclairage) eye-response curve.

BIN DISTRIBUTION :

- TEST MODE : The binning specification is testing in RED mode only.
- TEST CONDITION : See note.

WAVE LENGTH

Code	2	3	4	5	6	7	8	9	10
nm	618.1 : 620	620.1 : 622	622.1 : 624	624.1 : 626	626.1 : 628	628.1 : 630	630.1 : 632	632.1 : 634	634.1 : 636

BRIGHTNESS

Code	I	J	K	L	M	N
mcd	0.82 : 1.1	1.11 : 1.37	1.38 : 1.78	1.29 : 2.30	2.31 : 3.00	3.01 : 3.90

Note :

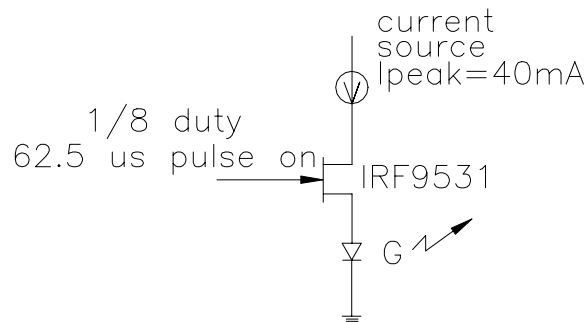
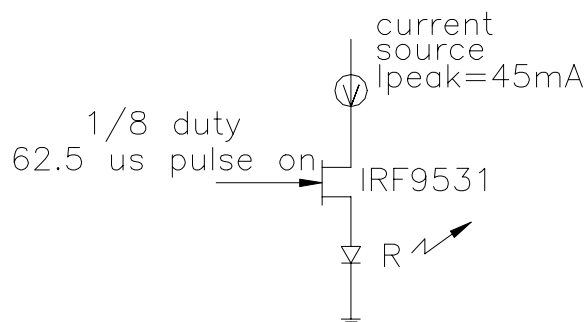

TYPICAL ELECTRICAL / OPTICAL CHARACTERISTIC CURVES

(25°C Ambient Temperature Unless Otherwise Noted)

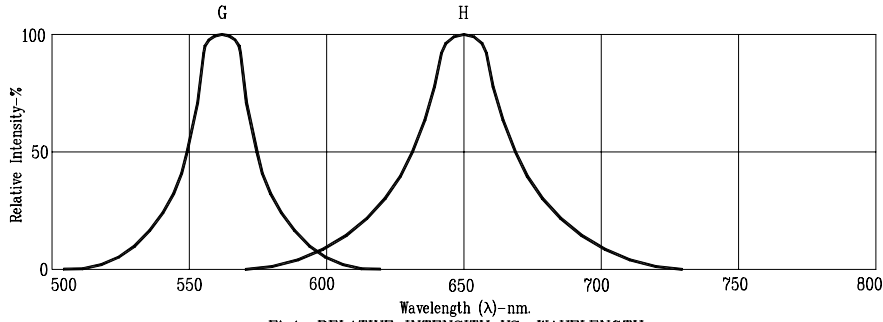

Fig1. RELATIVE INTENSITY VS. WAVELENGTH

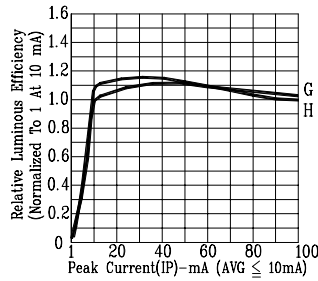

Fig2. RELATIVE LUMINOUS EFFICIENCY (LUMINOUS INTENSITY PER UNIT CURRENT) VS. PEAK CURRENT (REFRESH RATE 1KHz)

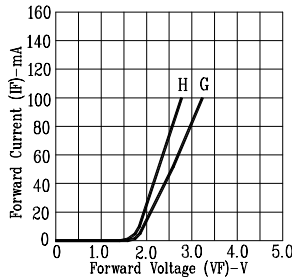

Fig3. FORWARD CURRENT VS. FORWARD VOLTAGE

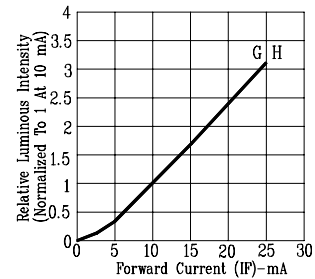

Fig4. RELATIVE LUMINOUS INTENSITY VS. FORWARD CURRENT

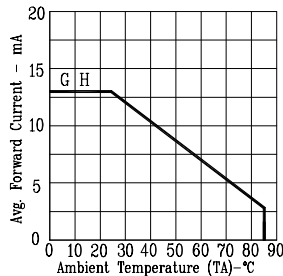

Fig5. MAX. AVERAGE FORWARD CURRENT VS. AMBIENT TEMPERATURE.

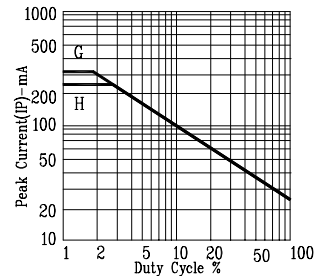

Fig6. MAX. PEAK CURRENT VS. DUTY CYCLE % (REFRESH RATE 1KHz)

NOTE: H=HI.EFF.-RED G=GREEN