

Distributed by:

**JAMECO**<sup>®</sup>  
ELECTRONICS

**www.Jameco.com ♦ 1-800-831-4242**

The content and copyrights of the attached  
material are the property of its owner.

Jameco Part Number 1996031



# 0.3" 5 × 7 Single Color Dot Matrix LED Displays

## LTP-305 Series

### Features

- 0.3 inch (7.62mm) matrix height.
- Choices of three bright colors-yellow/green/high efficiency red.
- Single plane, wide viewing angle.
- Solid state reliability.
- 36 light emitting diodes.
- Low power requirements.
- 5 × 7 array with X-Y select and decimal point.
- Compatible with usascII and ebcidc codes.
- Categorized for luminous intensity
- Easy mounting on P.C. board or sockets.

### Description

The LTP-305 series are 0.3 inch (7.62mm) matrix height 5 × 7 dot matrix displays. Yellow display have yellow package. Green displays have green package. High efficiency red displays have red package.

The red series devices utilize LED chips which are made from GaAsP on a GaAs substrate. The green series devices utilize LED chips which are made from GaP on a transparent GaP substrate. The yellow and high efficiency red series devices utilize LED chips which are made from GaAsP on a transparent GaP substrate.

### Package Dimensions

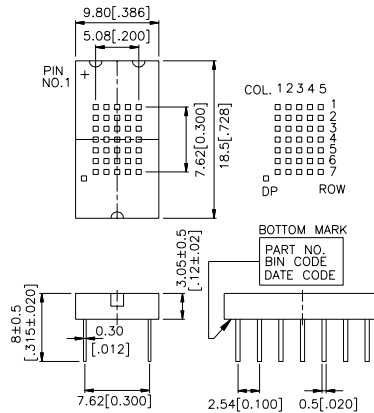

Notes : All dimensions are in millimeters(inches).  
Tolerance : ± 0.25mm (0.010") unless otherwise noted.

### Devices

Part No.			Description
Yellow	Green	Hi. Eff. Red	
LTP-305Y	LTP-305G	LTP305HR	Anode Column, Cathode Row; Lt. Hand Decimal

### Pin Connection

Pin No.	Connection	Pin No.	Connection
1	Anode Column 2	8	Anode Column 3
2	Cathode Row 1	9	Cathode Row 7
3	Cathode Row 3	10	Cathode Row 6
4	Cathode Row 4	11	Cathode Row 5
5	Anode Column 1	12	Cathode Row 2
6	No Pin	13	Anode Column 5
7	Anode Decimal (Point)	14	Anode Column 4

## Internal Circuit Diagram

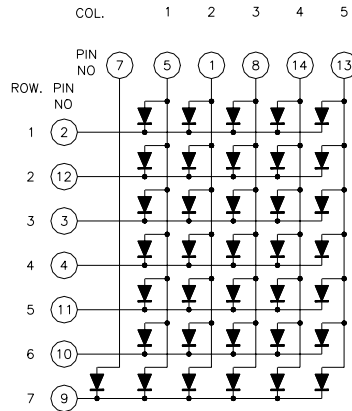

## Absolute Maximum Ratings at Ta=25°C

Parameter	Yellow	Green	Hi. Eff. Red	Unit
Average Power Dissipation Per Dot	22	26	26	mW
Peak Forward Current Per Dot	60	75	75	mA
Average Forward Current Per Dot Derating Linear from 25°C Per Dot	8 0.08	10 0.14	10 0.14	mA mA/°C
Reverse Voltage Per Dot	5	5	5	V
Operating Temperature Range	-35°C to +85°C			
Storage Temperature Range	-35°C to +85°C			
Solder Temperature 1/16 Inch Below Seating Plane for 3 Seconds at 260°C				

## Electrical/Optical Characteristics at Ta=25°C

LTP-305Y

Parameter	Symbol	Min.	Typ.	Max.	Unit	Test Condition
Average Luminous Intensity	I <sub>v</sub>	630	1600		μ cd	I <sub>p</sub> =80mA 1/16 Duty
Peak Emission Wavelength	λ <sub>P</sub>		585		nm	I <sub>f</sub> =20mA
Spectral Line Half-Width	Δλ		35		nm	I <sub>f</sub> =20mA
Dominant Wavelength	λ <sub>d</sub>		588		nm	I <sub>f</sub> =20mA
Forward Voltage, any Dot	V <sub>F</sub>		2.1	2.6	V	I <sub>f</sub> =20mA
			3.0	3.7	V	I <sub>f</sub> =80mA
Reverse Current, any Dot	I <sub>R</sub>			100	μ A	V <sub>R</sub> =5V
Luminous Intensity Matching Ratio	I <sub>v-m</sub>			2:1		I <sub>f</sub> =10mA

LTP-305G

Parameter	Symbol	Min.	Typ.	Max.	Unit	Test Condition
Average Luminous Intensity	I <sub>v</sub>	630	1600		μ cd	I <sub>p</sub> =80mA 1/16 Duty
Peak Emission Wavelength	λ <sub>P</sub>		565		nm	I <sub>f</sub> =20mA
Spectral Line Half-Width	Δλ		30		nm	I <sub>f</sub> =20mA
Dominant Wavelength	λ <sub>d</sub>		569		nm	I <sub>f</sub> =20mA
Forward Voltage, any Dot	V <sub>F</sub>		2.1	2.6	V	I <sub>f</sub> =20mA
			3.0	3.7	V	I <sub>f</sub> =80mA
Reverse Current, any Dot	I <sub>R</sub>			100	μ A	V <sub>R</sub> =5V
Luminous Intensity Matching Ratio	I <sub>v-m</sub>			2:1		I <sub>f</sub> =10mA

Parameter	Symbol	Min.	Typ.	Max.	Unit	Test Condition
Average Luminous Intensity	I <sub>v</sub>	630	1600		μ cd	I <sub>F</sub> =80mA 1/16 Duty
Peak Emission Wavelength	λ <sub>P</sub>		635		nm	I <sub>F</sub> =20mA
Spectral Line Half-Width	Δλ		40		nm	I <sub>F</sub> =20mA
Dominant Wavelength	λ <sub>d</sub>		623		nm	I <sub>F</sub> =20mA
Forward Voltage, any Dot	V <sub>F</sub>		2.0	2.6	V	I <sub>F</sub> =20mA
			2.6	3.4	V	I <sub>F</sub> =80mA
Reverse Current, any Dot	I <sub>R</sub>			100	μ A	V <sub>R</sub> =5V
Luminous Intensity Matching Ratio	I <sub>v</sub> -m			2:1		I <sub>F</sub> =10mA

Note: Luminous intensity is measured with a light sensor and filter combination that approximates the CIE (Commission Internationale De L'Eclairage) eye-response curve.

### Typical Electrical/Optical Characteristic Curves (25°C Ambient Temperature Unless Otherwise Noted)

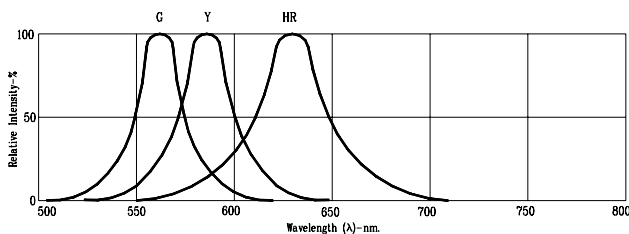

Fig1. RELATIVE INTENSITY VS. WAVELENGTH

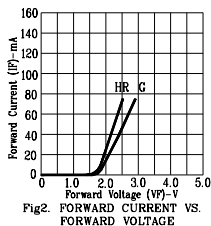

Fig2. FORWARD CURRENT VS. FORWARD VOLTAGE

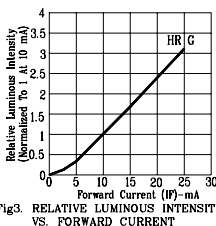

Fig3. RELATIVE LUMINOUS INTENSITY VS. FORWARD CURRENT

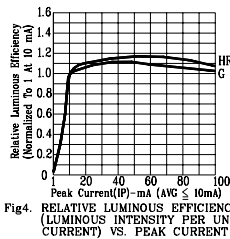

Fig4. RELATIVE LUMINOUS EFFICIENCY (LUMINOUS INTENSITY PER UNIT CURRENT) VS. PEAK CURRENT

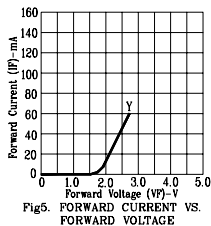

Fig5. FORWARD CURRENT VS. FORWARD VOLTAGE

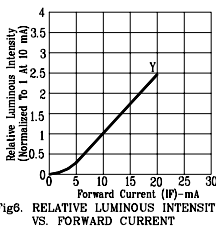

Fig6. RELATIVE LUMINOUS INTENSITY VS. FORWARD CURRENT

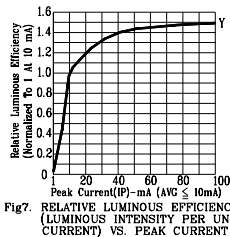

Fig7. RELATIVE LUMINOUS EFFICIENCY (LUMINOUS INTENSITY PER UNIT CURRENT) VS. PEAK CURRENT

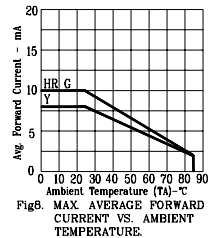

Fig8. MAX. AVERAGE FORWARD CURRENT VS. AMBIENT TEMPERATURE.

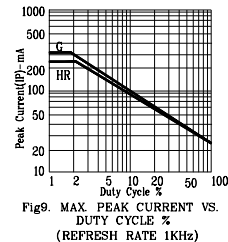

Fig9. MAX. PEAK CURRENT VS. DUTY CYCLE % (REFRESH RATE 1KHz)

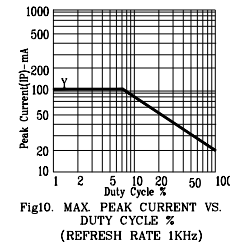

Fig10. MAX. PEAK CURRENT VS. DUTY CYCLE % (REFRESH RATE 1KHz)

NOTE: G=GREEN HR=HI.-EFF.RED Y=YELLOW (REFRESH RATE 1KHz)