



# LED Display Product Data Sheet LTP-4823G

Spec No.: DS-30-97-335

Effective Date: 05/30/2000

Revision: -

**LITE-ON DCC**

**RELEASE**

BNS-OD-FC001/A4

**FEATURES**

- \* 0.4 inch (10.0-mm) DIGIT HEIGHT.
- \* CONTINUOUS UNIFORM SEGMENTS.
- \* LOW POWER REQUIREMENTS.
- \* EXCELLENT CHARACTERS AND APPEARANCE.
- \* HIGH CONTRAST.
- \* HIGH BRIGHTNESS.
- \* WIDE VIEWING ANGLE.
- \* SOLID STATE RELIABILITY.
- \* COMMON ANODE OR COMMON CATHODE MODELS.
- \* CATEGORIZED FOR LUMINOUS INTENSITY.
- \* EASY MOUNTING ON P.C. BOARD.

**DESCRIPTION**

The LTP-4823G is a 0.4 inch (10 mm) digit height dual digit seven-segment display. This device utilizes green LED chips, which are made from GaP on a transparent GaP substrate, and has a gray face and white segments.

**DEVICE**

<b>PART NO.</b>	<b>DESCRIPTION</b>
GREEN	DUPLEX COMMON ANODE
LTP-4823G	RT. HAND DECIMAL

## PACKAGE DIMENSIONS

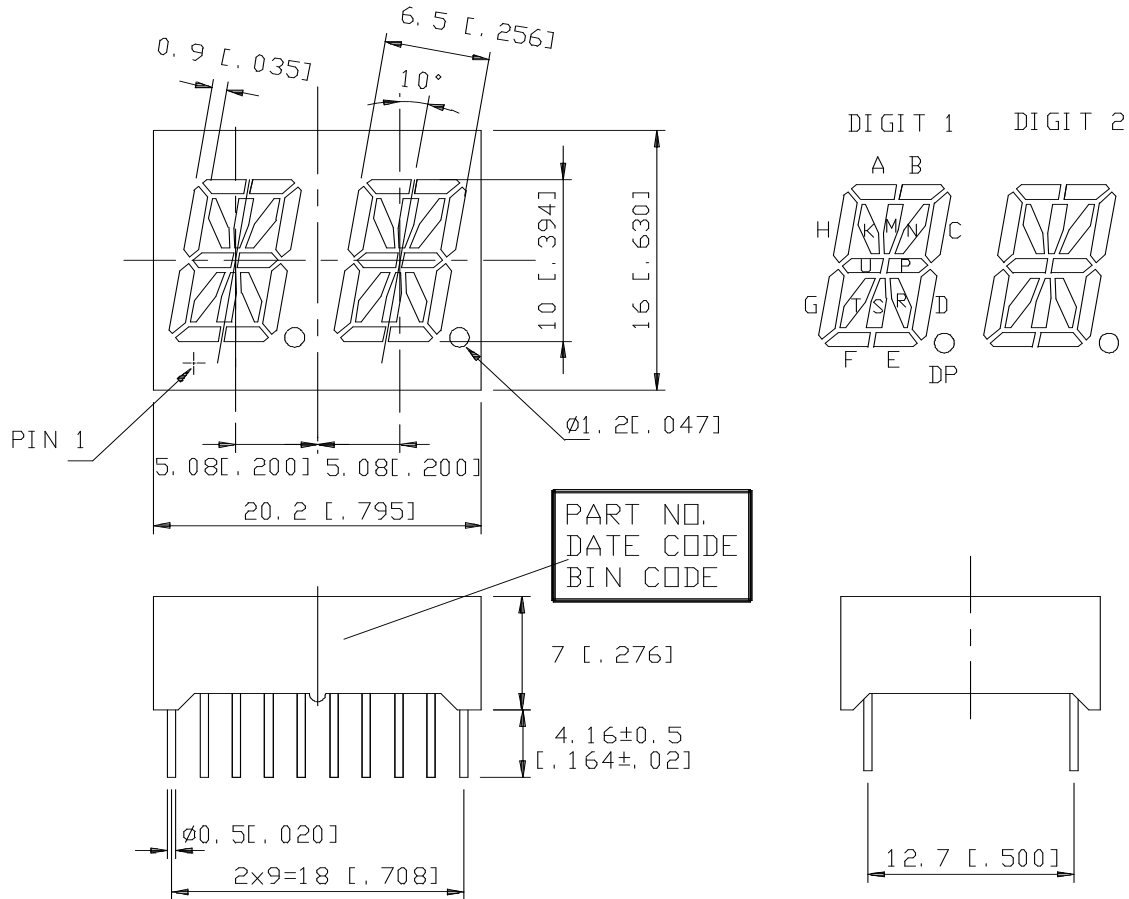

NOTES: All dimensions are in millimeters. Tolerances are  $\pm 0.25$  mm (0.01") unless otherwise noted.

## INTERNAL CIRCUIT DIAGRAM

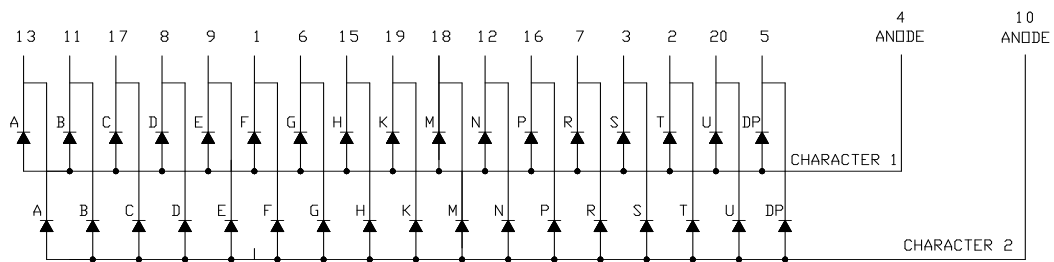

**PIN CONNECTION**

<b>No.</b>	<b>CONNECTION</b>
1	CATHODE F
2	CATHODE T
3	CATHODE S
4	COMMON ANODE CHARACTER 1
5	CATHODE DP
6	CATHODE G
7	CATHODE R
8	CATHODE D
9	CATHODE E
10	COMMON ANODE CHARACTER 2
11	CATHODE B
12	CATHODE N
13	CATHODE A
14	NO CONNECTION
15	CATHODE H
16	CATHODE P
17	CATHODE C
18	CATHODE M
19	CATHODE K
20	CATHODE U

**ABSOLUTE MAXIMUM RATING AT Ta=25°C**

PARAMETER	MAXIMUM RATING	UNIT
Average Power Dissipation Per Segment	75	mW
Peak Forward Current Per Segment	100	mA
Average Forward Current Per Segment	25	mA
Derating Linear From 25°C Per Segment	0.33	mA/°C
Reverse Voltage Per Segment	5	V
Operating Temperature Range	-35°C to +85°C	
Storage Temperature Range	-35°C to +85°C	
Solder Temperature: max 260°C for max 3sec at 1.6mm[1/16inch] below seating plane.		

**ELECTRICAL / OPTICAL CHARACTERISTICS AT Ta=25°C**

PARAMETER	SYMBOL	MIN.	TYP.	MAX.	UNIT	TEST CONDITION
Average Luminous Intensity	I <sub>v</sub>	800	2200		μcd	I <sub>p</sub> =10mA
Peak Emission Wavelength	λ <sub>p</sub>		565		nm	I <sub>F</sub> =20mA
Spectral Line Half-Width	Δλ		30		nm	I <sub>F</sub> =20mA
Dominant Wavelength	λ <sub>d</sub>		569		nm	I <sub>F</sub> =20mA
Forward Voltage Per Segment	V <sub>F</sub>		2.1	2.6	V	I <sub>F</sub> =20mA
Reverse Current Per Segment	I <sub>R</sub>			100	μA	V <sub>R</sub> =5V
Luminous Intensity Matching Ratio	I <sub>v</sub> -m			2:1		I <sub>F</sub> =10mA

Note: Luminous intensity is measured with a light sensor and filter combination that approximates the CIE (Commision Internationale De L'Eclairage) eye-response curve.

**TYPICAL ELECTRICAL / OPTICAL CHARACTERISTIC CURVES**

(25°C Ambient Temperature Unless Otherwise Noted)

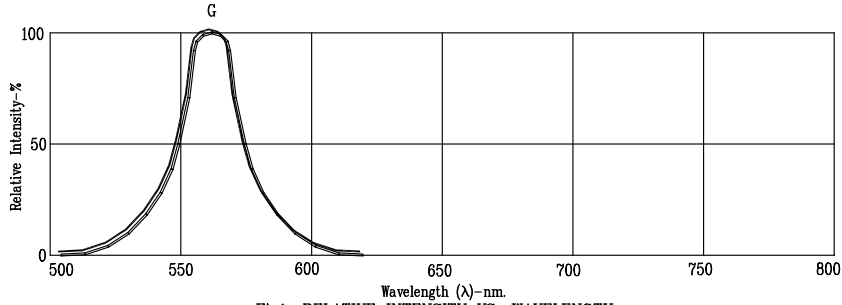

Fig.1. RELATIVE INTENSITY VS. WAVELENGTH

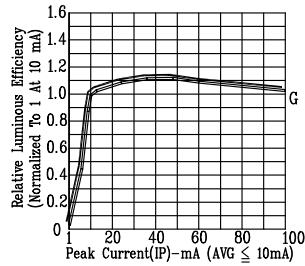

Fig.2. RELATIVE LUMINOUS EFFICIENCY (LUMINOUS INTENSITY PER UNIT CURRENT) VS. PEAK CURRENT (REFRESH RATE 1KHz)

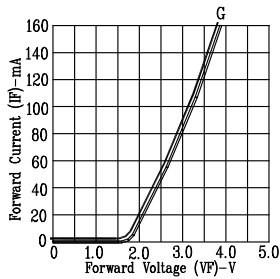

Fig.3. FORWARD CURRENT VS. FORWARD VOLTAGE

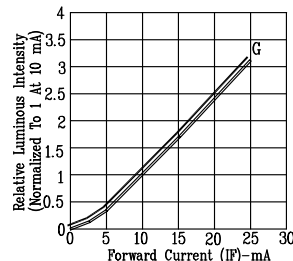

Fig.4. RELATIVE LUMINOUS INTENSITY VS. FORWARD CURRENT

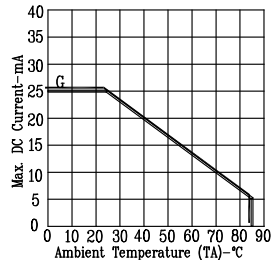

Fig.5. MAX ALLOWABLE DC CURRENT VS. AMBIENT TEMPERATURE

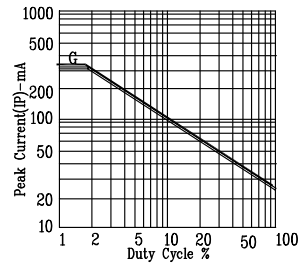

Fig.6. MAX PEAK CURRENT VS. DUTY CYCLE % (REFRESH RATE 1KHz)

NOTE: G=GREEN