



LED Display Product Data Sheet LTP-4823KF

Spec No.: DS30-2007-0165

Effective Date: 10/03/2007

Revision: -

LITE-ON DCC

RELEASE

BNS-OD-FC001/A4

LED DISPLAY

LTP-4823KF

DATA SHEET

Rev	Description	By
-	Original Spec	<u>Phanomkorn J.</u>

SPEC. NO.: DS30-2007-0165

D A T E : 05/September/'07

REV. NO.: -

LITEON LITE-ON TECHNOLOGY CORPORATION

Property of Lite-On Only

FEATURES

- * 0.4 inch (10 mm) DIGIT HEIGHT.
- * CONTINUOUS UNIFORM SEGMENTS.
- * LOW POWER REQUIREMENT.
- * EXCELLENT CHARACTERS APPEARANCE.
- * HIGH BRIGHTNESS & HIGH CONTRAST.
- * WIDE VIEWING ANGLE.
- * SOLID STATE RELIABILITY.
- * CATEGORIZED FOR LUMINOUS INTENSITY.
- * **LEAD-FREE PACKAGE (ACCORDING TO ROHS)**

DESCRIPTION

The LTP-4823KF is a 0.4 inch (10 mm) digit height dual digit 16-segments alphanumeric display. This device utilizes AlInGaP Yellow Orange LED chips, which are made from AlInGaP on a non-transparent GaAs substrate, and has a gray face and white segments.

DEVICE

PART NO.	DESCRIPTION
AllInGaP Yellow Orange	DUPLEX COMMON ANODE RT. HAND DECIMAL
LTP-4823KF	

PACKAGE DIMENSIONS

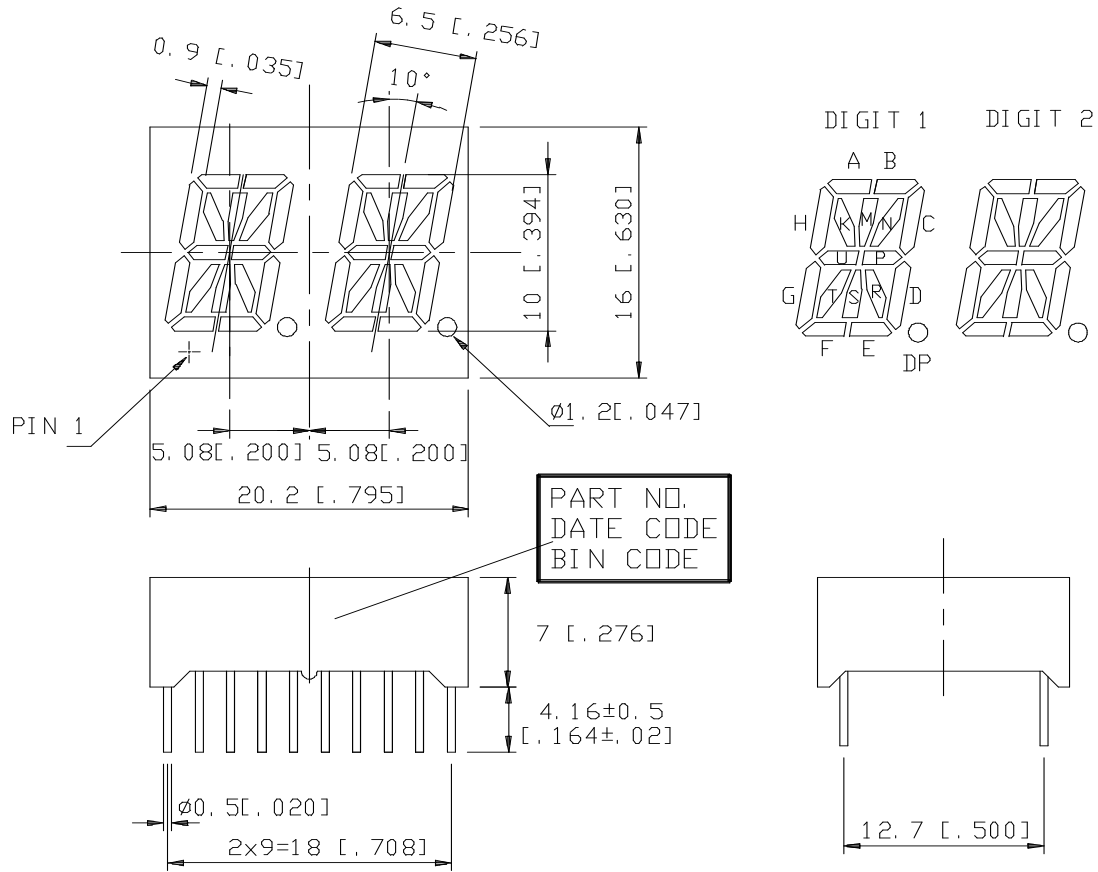

- NOTES: 1. All dimensions are in millimeters. Tolerances are ± 0.25 mm unless otherwise note.
 2. Pin tip's shift tolerance is ± 0.4 mm.

INTERNAL CIRCUIT DIAGRAM

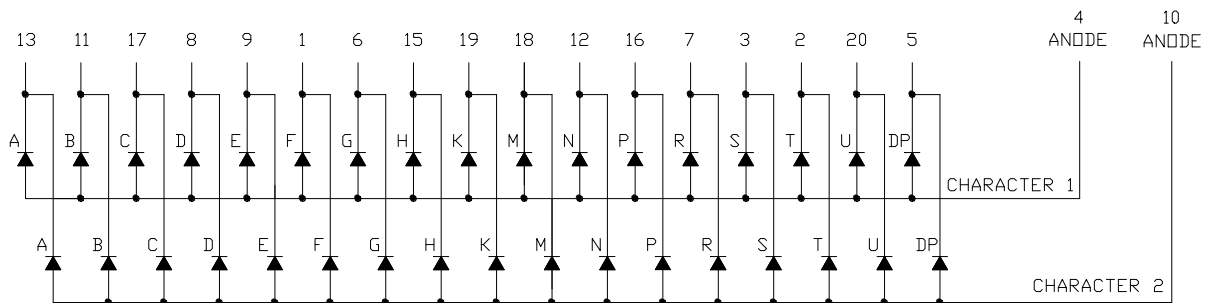

PIN CONNECTION

No.	CONNECTION
1	CATHODE F
2	CATHODE T
3	CATHODE S
4	COMMON ANODE CHARACTER 1
5	CATHODE D.P.
6	CATHODE G
7	CATHODE R
8	CATHODE D
9	CATHODE E
10	COMMON ANODE CHARACTER 2
11	CATHODE B
12	CATHODE N
13	CATHODE A
14	NO CONNECTION
15	CATHODE H
16	CATHODE P
17	CATHODE C
18	CATHODE M
19	CATHODE K
20	CATHODE U

LITEON LITE-ON TECHNOLOGY CORPORATION

Property of Lite-On Only

ABSOLUTE MAXIMUM RATING AT Ta=25°C

PARAMETER	MAXIMUM RATING	UNIT
Average Power Dissipation Per Segment	70	mW
Peak Forward Current Per Segment	60	mA
Average Forward Current Per Segment	25	mA
Derating Linear From 25°C Per Segment	0.33	mA/°C
Reverse Voltage Per Segment	5	V
Operating Temperature Range	-35°C to +105°C	
Storage Temperature Range	-35°C to +105°C	

Soldering Conditions: 1/16 inch below seating plane for 3 seconds at 260°C
or of temperature unit (during assembly) not over max. temperature rating above.

ELECTRICAL / OPTICAL CHARACTERISTICS AT Ta=25°C

PARAMETER	SYMBOL	MIN.	TYP.	MAX.	UNIT	TEST CONDITION
Average Luminous Intensity	I _v	500	1300		μcd	I _F =1mA
Peak Emission Wavelength	λ _p		611		nm	I _F =20mA
Spectral Line Half-Width	Δλ		17		nm	I _F =20mA
Dominant Wavelength	λ _d		605		nm	I _F =20mA
Forward Voltage Per Segment	V _F		2.05	2.6	V	I _F =20mA
Reverse Current Per Segment	I _R			100	μA	V _R =5V
Luminous Intensity Matching Ratio (Similar Light Area)	I _{v-m}			2:1		I _F =1mA

Note: Luminous intensity is measured with a light sensor and filter combination that approximates the CIE (Commission Internationale De L'Eclairage) eye-response curve.

BIN TABLE 2

RANGE	321-500	501-800	801-1300	1301-2100	2101-3400
BIN	F	G	H	J	K

TYPICAL ELECTRICAL / OPTICAL CHARACTERISTIC CURVES

(25°C Ambient Temperature Unless Otherwise Noted)

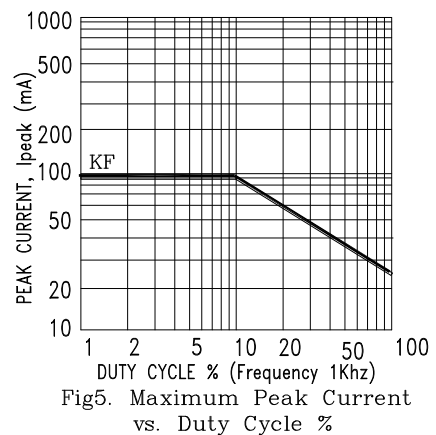
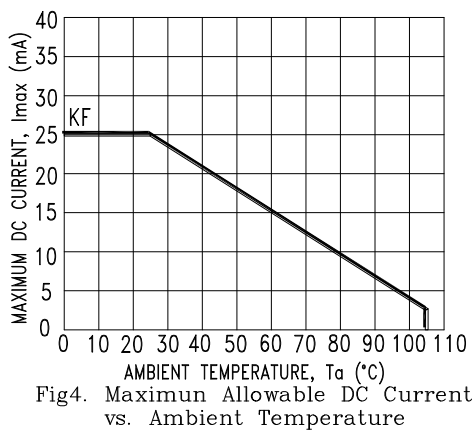
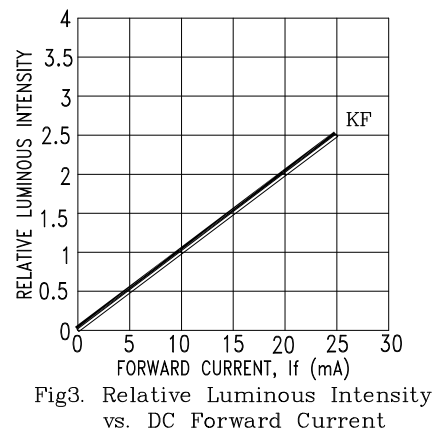
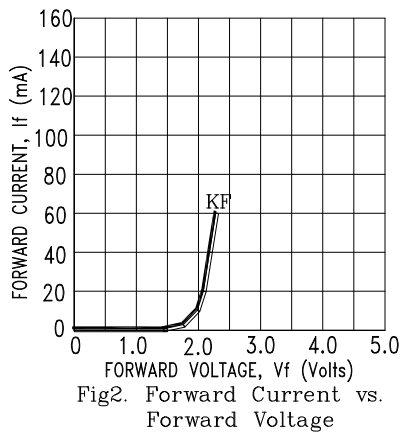
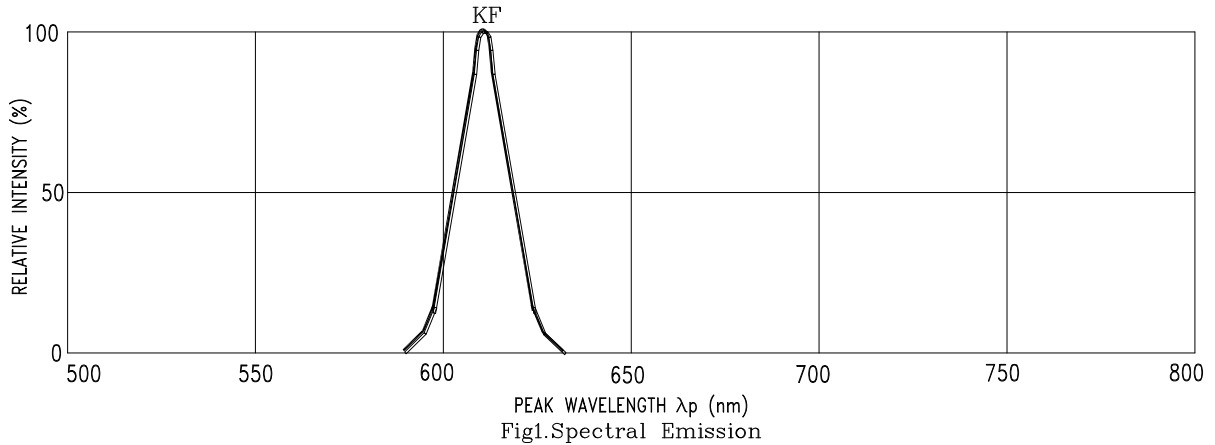

NOTE : KF=AlInGaP YELLOW ORANGE