

ELECTRO-OPTICAL CHARACTERISTICS Ta=25°C If=20mA						
PARAMETER	SYMBOL	MIN	TYP	MAX	UNITS	TEST COND
FORWARD VOLTAGE	Vf		3.2	3.3	Vf	
REVERSE VOLTAGE	Vr	5.0			Vr	Ir=100µA
LUMINOUS FLUX*	Iv	19	19.7	20.3	lm	
COLOR TEMPERATURE		6500	6725	6950	K	
VIEWING ANGLE			120		2x theta	
EMITTED COLOR:	COOL WHITE					
LENS FINISH:	WATER CLEAR					

*LUMINOUS FLUX TESTING CONDITION 550nm WAVELENGTH.

LIMITS OF SAFE OPERATION AT 25°C		
PARAMETER	MAX	UNITS
PEAK FORWARD CURRENT*	100	mA
STEADY CURRENT	80	mA
POWER DISSIPATION	315	mW
DERATE FROM 25°C	-1.2	mW/°C
OPERATING TEMP.	-30 TO +85	°C
STORAGE TEMP.	-40 TO +85	°C

* t<10µs

ZENER DIODE					
PARAMETER	MIN	TYP	MAX	UNITS	TEST COND
REVERSE LEAKAGE CURRENT			0.5	µA	Vr=5V
ZENER VOLTAGE	5.8	6.3	6.8	V	Iz=5mA
FORWARD VOLTAGE			1.2	V	If=20mA

COLOR	CIE-X	CIE-Y
COOL WHITE	0.3288	0.3525
	0.3153	0.3390
	0.3167	0.3259
	0.3290	0.3387

CAUTION: MOISTURE SENSITIVE DEVICE
PER JEDEC LEVEL 3 STANDARDS

CAUTION: STATIC SENSITIVE DEVICE
FOLLOW PROPER E.S.D. HANDLING PROCEDURES
WHEN WORKING WITH THIS PART.

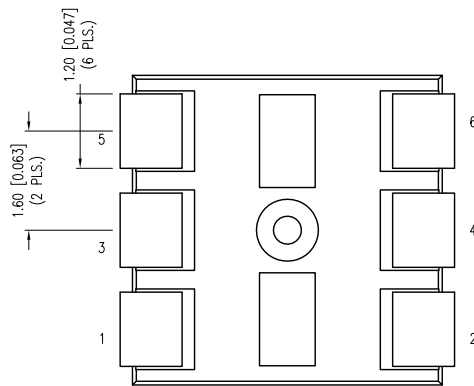
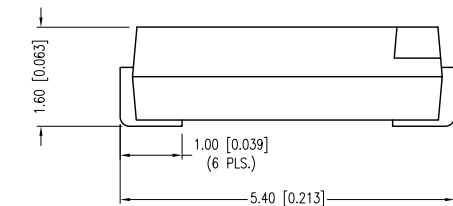

RECOMMENDED SOLDER PAD LAYOUT

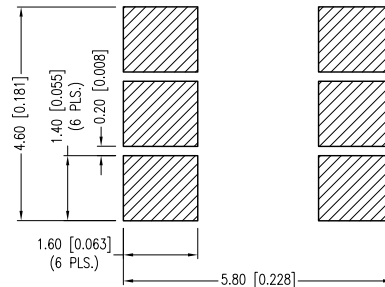

*UNLESS OTHERWISE SPECIFIED TOLERANCES PER DECIMAL PRECISION ARE: X=±1 (±0.039), X.X=±0.5 (±0.020), X.XX=±0.25 (±0.010), X.XXX=±0.127 (±0.005). LEAD SIZE=±0.05 (±0.002), LEAD LENGTH=±0.75 (±0.030). MIN= +DECIMAL PRECISION MAX.= +0.00 -DECIMAL PRECISION



425 N. GARY AVE.
CAROL STREAM, IL 60188-4900
PHONE: +1.800.278.5666
FAX: +1.630.315.2152
WEB: WWW.LUMEX.COM
MEMBER OF ITW PHOTONICS GROUP

5.0x5.0mm SML W/REFLECTOR, WHITE, WATER CLEAR, TAPE & REEL.

THE SPECIFICATIONS MAY CHANGE AT ANY TIME WITHOUT NOTICE DUE TO NEW MATERIALS OR PRODUCT IMPROVEMENT.

CONFIDENTIAL INFORMATION
THE INFORMATION CONTAINED IN THIS DOCUMENT IS THE PROPERTY OF LUMEX INC. EXCEPT AS SPECIFICALLY AUTHORIZED IN WRITING BY LUMEX INC., THE HOLDER OF THIS DOCUMENT SHALL KEEP ALL INFORMATION CONTAINED HEREIN CONFIDENTIAL AND SHALL PROTECT SAME IN WHOLE OR IN PART FROM DISCLOSURE AND DISSEMINATION TO ALL THIRD PARTIES.

DATE: 6.28.12	DRAWN BY: AB
PAGE: 1 OF 3	CHKD BY: DT
SCALE: NTS	APRVD BY: DT
UNIT: mm [INCH]	Ⓟ

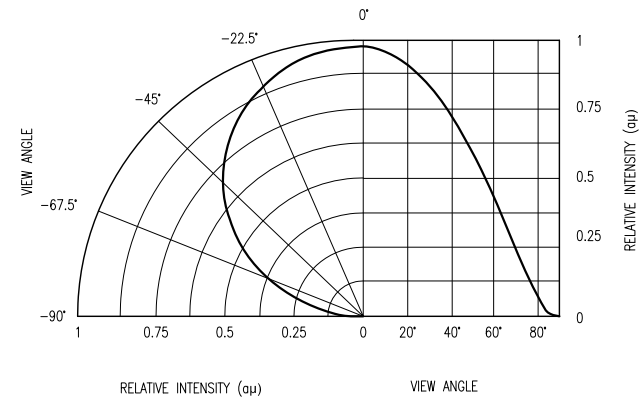
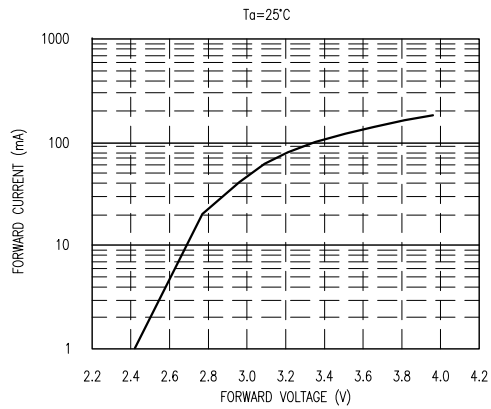
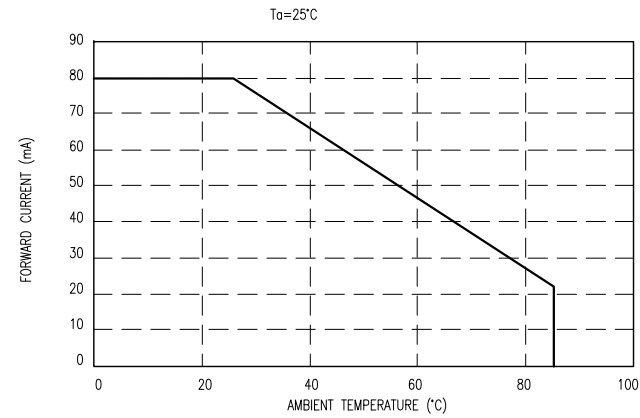
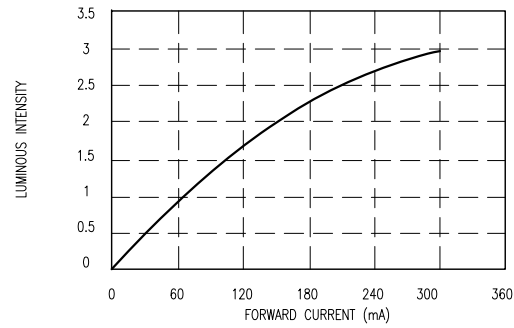

*UNLESS OTHERWISE SPECIFIED TOLERANCES PER DECIMAL PRECISION ARE: X=±1 (±0.039), X.X=±0.5 (±0.020), X.XX=±0.25 (±0.010), X.XXX=±0.127 (±0.005). LEAD SIZE=±0.05 (±0.002), LEAD LENGTH=±0.75 (±0.030). MIN.= +DECIMAL PRECISION -0.00 MAX.= +0.00 -DECIMAL PRECISION



425 N. GARY AVE.
 CAROL STREAM, IL 60188-4900
 PHONE: +1.800.278.5666
 FAX: +1.630.315.2152
 WEB: WWW.LUMEX.COM
 MEMBER OF ITW PHOTONICS GROUP

5.0x5.0mm SML W/REFLECTOR, WHITE, WATER CLEAR, TAPE & REEL.

THE SPECIFICATIONS MAY CHANGE AT ANY TIME WITHOUT NOTICE DUE TO NEW MATERIALS OR PRODUCT IMPROVEMENT.

CONFIDENTIAL INFORMATION
 THE INFORMATION CONTAINED IN THIS DOCUMENT IS THE PROPERTY OF LUMEX INC. EXCEPT AS SPECIFICALLY AUTHORIZED IN WRITING BY LUMEX INC., THE HOLDER OF THIS DOCUMENT SHALL KEEP ALL INFORMATION CONTAINED HEREIN CONFIDENTIAL AND SHALL PROTECT SAME IN WHOLE OR IN PART FROM DISCLOSURE AND DISSEMINATION TO ALL THIRD PARTIES.

DATE:	6.28.12	DRAWN BY:	AB
PAGE:	2 OF 3	CHKD BY:	DT
SCALE:	NTS	APRVD BY:	DT
UNIT:	mm [INCH]		Ⓟ

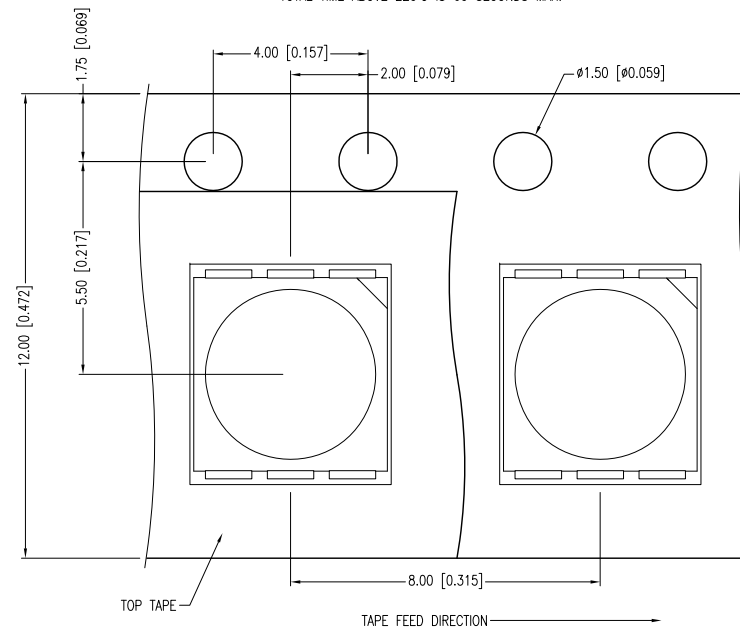
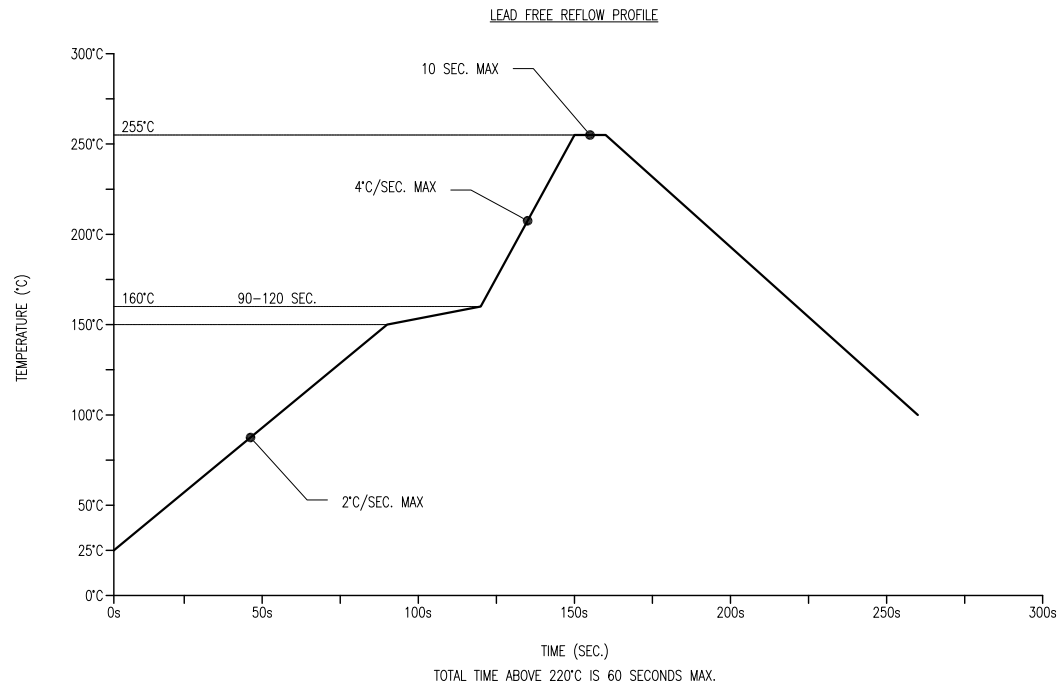

NOTES:

1. THE POLARITY MARK IS ORIENTED TOWARDS THE TAPE SPROCKET HOLE.
2. 1,000 PIECES PER REEL.

*UNLESS OTHERWISE SPECIFIED TOLERANCES PER DECIMAL PRECISION ARE: X=±1 (±0.039), X.X=±0.5 (±0.020), X.XX=±0.25 (±0.010), X.XXX=±0.127 (±0.005). LEAD SIZE=±0.05 (±0.002), LEAD LENGTH=±0.75 (±0.030). MIN.= ^{+DECIMAL PRECISION} -0.00 ^{-DECIMAL PRECISION} MAX.= ^{+DECIMAL PRECISION} -0.00 ^{-DECIMAL PRECISION}

UNCONTROLLED DOCUMENT



425 N. GARY AVE.
 CAROL STREAM, IL 60188-4900
 PHONE: +1.800.278.5666
 FAX: +1.630.315.2152
 WEB: WWW.LUMEX.COM
 MEMBER OF ITW PHOTONICS GROUP

5.0x5.0mm SML W/REFLECTOR, WHITE, WATER CLEAR, TAPE & REEL.

THE SPECIFICATIONS MAY CHANGE AT ANY TIME WITHOUT NOTICE DUE TO NEW MATERIALS OR PRODUCT IMPROVEMENT.

CONFIDENTIAL INFORMATION
 THE INFORMATION CONTAINED IN THIS DOCUMENT IS THE PROPERTY OF LUMEX INC. EXCEPT AS SPECIFICALLY AUTHORIZED IN WRITING BY LUMEX INC., THE HOLDER OF THIS DOCUMENT SHALL KEEP ALL INFORMATION CONTAINED HEREIN CONFIDENTIAL AND SHALL PROTECT SAME IN WHOLE OR IN PART FROM DISCLOSURE AND DISSEMINATION TO ALL THIRD PARTIES.

DATE:	6.28.12	DRAWN BY:	AB
PAGE:	3 OF 3	CHKD BY:	DT
SCALE:	NTS	APRVD BY:	DT
UNIT:	mm [INCH]		Ⓟ