

SPECIFICATIONS FOR NICHIA CHIP TYPE WARM WHITE LED

MODEL : NSSL157T-H3

NICHIA CORPORATION

1. SPECIFICATIONS

(1) Absolute Maximum Ratings (Ta=25°C)

Item	Symbol	Absolute Maximum Rating	Unit
Forward Current	I _F	150	mA
Pulse Forward Current	I _{FP}	200	mA
Allowable Reverse Current	I _R	85	mA
Power Dissipation	P _D	540	mW
Operating Temperature	T _{opr}	-40 ~ +100	°C
Storage Temperature	T _{stg}	-40 ~ +100	°C
Dice Temperature	T _j	120	°C
Soldering Temperature	T _{sld}	Reflow Soldering : 260°C for 10sec. Hand Soldering : 350°C for 3sec.	

I_{FP} Conditions : Pulse Width ≤ 10msec. and Duty ≤ 1/10

(2) Initial Electrical/Optical Characteristics (Ta=25°C)

Item	Symbol	Condition	Typ.	Max.	Unit
Forward Voltage	V _F	I _F =80[mA]	(3.2)	3.6	V
Luminous Flux	φ _v	I _F =80[mA]	(23)	-	lm
Chromaticity Coordinate	x	I _F =80[mA]	0.41	-	-
	y	I _F =80[mA]	0.39	-	-
Color Rendering	R _a	I _F =80[mA]	(85)	-	-

* Forward Voltage Measurement allowance is ± 0.05V.

* Luminous flux value is traceable to the CIE 127:2007-compliant national standards.

* Please refer to CIE 1931 chromaticity diagram.

(3) Ranking (Ta=25°C)

Item	Symbol	Condition	Min.	Max.	Unit
Luminous Flux	Rank P10	I _F =80[mA]	25.5	30.3	lm
	Rank P9		21.4	25.5	
	Rank P8		18.0	21.4	
Color Rendering	R _a	I _F =80[mA]	75	-	-

* Luminous Flux Measurement allowance is ± 7%.

* Color Rendering Measurement allowance is ± 5.

Color Ranks

	Rank sw27			
x	0.4373	0.4562	0.4813	0.4593
y	0.3893	0.4260	0.4319	0.3944

	Rank sw35			
x	0.3898	0.3996	0.4299	0.4147
y	0.3716	0.4015	0.4165	0.3814

(I_F=80mA, Ta=25°C)

	Rank sw30			
x	0.4147	0.4299	0.4562	0.4373
y	0.3814	0.4165	0.4260	0.3893

	Rank sw40			
x	0.3670	0.3736	0.3996	0.3898
y	0.3578	0.3874	0.4015	0.3716

	Rank sw45			
x	0.3515	0.3548	0.3736	0.3670
y	0.3487	0.3736	0.3874	0.3578

* Color Coordinates Measurement allowance is ± 0.005 .

* Basically, a shipment shall consist of the LEDs of a combination of the above ranks.

The percentage of each rank in the shipment shall be determined by Nichia.

2.INITIAL OPTICAL/ELECTRICAL CHARACTERISTICS

Please refer to “CHARACTERISTICS” on the following pages.

3.OUTLINE DIMENSIONS AND MATERIALS

Please refer to “OUTLINE DIMENSIONS” on the following page.

4.PACKAGING

· The LEDs are packed in cardboard boxes after taping.

Please refer to “TAPING DIMENSIONS” and “PACKING” on the following pages.

The label on the minimum packing unit shows ; Part Number, Lot Number, Ranking, Quantity

· In order to protect the LEDs from mechanical shock, we pack them in cardboard boxes for transportation.

· The LEDs may be damaged if the boxes are dropped or receive a strong impact against them, so precautions must be taken to prevent any damage.

· The boxes are not water resistant and therefore must be kept away from water and moisture.

· When the LEDs are transported, we recommend that you use the same packing method as Nichia.

5.LOT NUMBER

The first six digits number shows **lot number**.

The lot number is composed of the following characters;

○□×××× - ◇◇◇

○ - Year (9 for 2009, A for 2010)

□ - Month (1 for Jan., 9 for Sep., A for Oct., B for Nov.)

×××× - Nichia's Product Number

◇◇◇ - Ranking by Color Coordinates, Ranking by Luminous Flux

6.RELIABILITY

(1) TEST ITEMS AND RESULTS

Test Item	Standard Test Method	Test Conditions	Note	Number of Damaged
Resistance to Soldering Heat (Reflow Soldering)	JEITA ED-4701 300 301	Tsld=260°C, 10sec. (Pre treatment 30°C,70%,168hrs.)	2 times	0/22
Solderability (Reflow Soldering)	JEITA ED-4701 303 303A	Tsld=245 ± 5°C, 5sec. using flux Lead-free Solder (Sn-3.0Ag-0.5Cu)	1 time over 95%	0/22
Temperature Cycle	JEITA ED-4701 100 105	-40°C ~ 25°C ~ 100°C ~ 25°C 30min. 5min. 30min. 5min.	100 cycles	0/50
Moisture Resistance Cyclic	JEITA ED-4701 200 203	25°C ~ 65°C ~ -10°C 90%RH 24hrs./1cycle	10 cycles	0/22
High Temperature Storage	JEITA ED-4701 200 201	Ta=100°C	1000 hrs.	0/22
Temperature Humidity Storage	JEITA ED-4701 100 103	Ta=60°C, RH=90%	1000 hrs.	0/22
Low Temperature Storage	JEITA ED-4701 200 202	Ta=-40°C	1000 hrs.	0/22
Steady State Operating Life Condition 1		Ta=25°C, IF=80mA Tested with Nichia standard circuit board.*	1000 hrs.	0/22
Steady State Operating Life Condition 2		Ta=25°C, IF=150mA Tested with Nichia standard circuit board.*	500 hrs.	0/22
Steady State Operating Life of High Temperature		Ta=100°C, IF=65mA Tested with Nichia standard circuit board.*	1000 hrs.	0/22
Steady State Operating Life of High Humidity Heat		60°C, RH=90%, IF=100mA Tested with Nichia standard circuit board.*	500 hrs.	0/22
Steady State Operating Life of Low Temperature		Ta=-40°C, IF=80mA	1000 hrs.	0/22
Vibration	JEITA ED-4701 400 403	100 ~ 2000 ~ 100Hz Sweep 4min. 200m/s ² 3directions, 4cycles	48min.	0/22
Electrostatic Discharges	JEITA ED-4701 300 304	R=1.5kΩ, C=100pF Test Voltage=2kV	3 times Negative/Positive	0/22
Adhesion Strength	JEITA ED-4702	5N, 10 ± 1 sec.	1 time	0/22

* Thermal resistance of LED with Nichia standard circuit board : $R_{ja} \cong 120^{\circ}\text{C}/\text{W}$
Nichia standard circuit board : FR4, t=1.6mm, Copper foil, t=0.07mm

(2) CRITERIA FOR JUDGING DAMAGE

Item	Symbol	Test Conditions	Criteria for Judgement	
			Min.	Max.
Forward Voltage	V _F	IF=80mA	-	U.S.L.*) × 1.1
Luminous Flux	φ _v	IF=80mA	L.S.L.***) × 0.7	-

*) U.S.L. : Upper Standard Level

**) L.S.L. : Lower Standard Level

7.CAUTIONS

The LEDs are devices which are materialized by combining Blue LEDs and special phosphors. Consequently, the color of the LEDs is changed a little by an operating current. Care should be taken after due consideration when using LEDs.

(1) Moisture Proof Package

- When moisture is absorbed into the SMT package it may vaporize and expand during soldering. There is a possibility that this can cause exfoliation of the contacts and damage to the optical characteristics of the LEDs. For this reason, the moisture proof package is used to keep moisture to a minimum in the package.
- The moisture proof package is made of an aluminum moisture proof bag. A package of a moisture absorbent material (silica gel) is inserted into the aluminum moisture proof bag. The silica gel changes its color from blue to red as it absorbs moisture.

(2) Storage

· Storage Conditions

Before opening the package :

The LEDs should be kept at 30°C or less and 90%RH or less. The LEDs should be used within a year. When storing the LEDs, moisture proof packaging with absorbent material (silica gel) is recommended.

After opening the package :

The LEDs should be kept at 30°C or less and 70%RH or less. The LEDs should be soldered within 168 hours (7days) after opening the package. If unused LEDs remain, they should be stored in moisture proof packages, such as sealed containers with packages of moisture absorbent material (silica gel). It is also recommended to return the LEDs to the original moisture proof bag and to reseal the moisture proof bag again.

- If the moisture absorbent material (silica gel) has faded away or the LEDs have exceeded the storage time, baking treatment should be performed using the following conditions.
Baking treatment : more than 24 hours at $65 \pm 5^{\circ}\text{C}$
- This product has silver plated metal parts that are inside and/or outside the package body. The silver plating becomes tarnished when being exposed to an environment which contains corrosive gases. Any LED with tarnished leads may lead to poor solderability and deterioration of optical characteristics. Please do not expose the LEDs to corrosive atmosphere during storage.
- After assembly and during use, silver plating can be affected by the corrosive gases emitted by components and materials in close proximity of the LEDs within an end product, and the gases entering into the product from the external atmosphere. The above should be taken into consideration when designing.
- Please avoid rapid transitions in ambient temperature, especially in high humidity environments where condensation can occur.

(3) Static Electricity

- Static electricity or surge voltage damages the LEDs.
It is recommended that a wrist band or an anti-electrostatic glove be used when handling the LEDs.
- All devices, equipment and machinery must be properly grounded. It is recommended that precautions be taken against surge voltage to the equipment that mounts the LEDs.
- When inspecting the final products in which LEDs were assembled, it is recommended to check whether the assembled LEDs are damaged by static electricity or not. It is easy to find static-damaged LEDs by a light-on test or a VF test at a lower current (below 1mA is recommended).
- Damaged LEDs will show some unusual characteristics such as the forward voltage becomes lower, or the LEDs do not light at the low current.

Criteria : ($V_F > 2.0V$ at $I_F=0.5mA$)

(4) Application Design Considerations

- In designing a circuit, the current through each LED must not exceed the absolute maximum rating. It is recommended to use Circuit B which regulates the current flowing through each LED. In the meanwhile, when driving LEDs with a constant voltage in Circuit A, the current through the LEDs may vary due to the variation in forward voltage (V_F) of the LEDs. In the worst case, some LED may be subjected to stresses in excess of the absolute maximum rating.

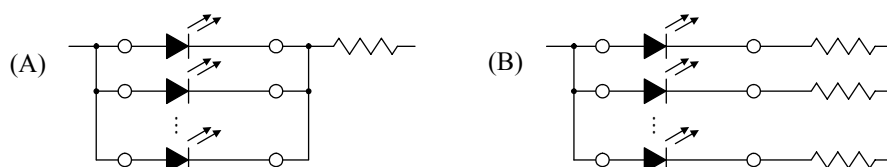

- This product should be operated in forward bias. A driving circuit must be designed so that the product is not subjected to either forward or reverse voltage while it is off. In particular, if a reverse voltage is continuously applied to the product, such operation can cause migration resulting in LED damage.
- For stabilizing the LED characteristics, it is recommended to operate at 10% of the rated current or higher.

- Thermal design of the end product is of paramount importance. Please consider the heat generation of the LED when making the system design. The coefficient of temperature increase per input electric power is affected by the thermal resistance of the circuit board and density of LED placement on the board, as well as other components. It is necessary to avoid intense heat generation and operate within the maximum dice temperature (T_j).
- Please determine the operating current with consideration of the ambient temperature local to the LED and refer to the plot of Ambient temperature vs. Allowable Forward Current on CHARACTERISTICS in this specifications. Please also take measures to remove heat from the area near the LED to improve the operational characteristics of the LED.
- The equation ① indicates correlation between T_j and T_a , and the equation ② indicates correlation between T_j and T_s .

$$T_j = T_a + R_{ja} \cdot W \quad \text{..... ①} \qquad T_j = T_s + R_{js} \cdot W \quad \text{..... ②}$$

* T_j = Dice Temperature : °C, T_a = Ambient Temperature : °C,
 T_s = Solder Temperature (Cathode Side) : °C,
 R_{ja} = Heat resistance from Dice to Ambient temperature : °C /W,
 R_{js} = Heat resistance from Dice to T_s measuring point $\cong 55^\circ\text{C} /\text{W}$,
 W = Inputting Power ($I_F \times V_F$) : W

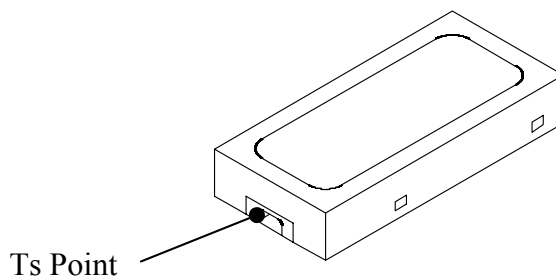

- Warpage of circuit board with soldered LEDs may result in damage or package breakage of the LEDs. Please pay special attention to the orientation of the LEDs as to avoid LED failure caused by bow, twist and warpage of the board.
- Depending on the position and direction of LED, the mechanical stress on the LED package can be changed. Refer to the following figure.

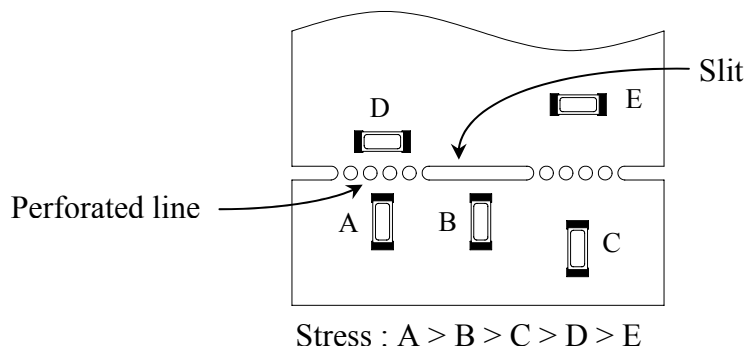

- When separating the circuit boards with soldered LEDs, please use appropriate tools and equipment. Hand brake without these tools and equipment may not be used.

(5) Handling Precautions

- Bare Hand

When handling the product, touching encapsulant with bare hands will contaminate its surface that could affect on optical characteristics. In the worst cases, excessive force to the encapsulant by hands might result in catastrophic failure of the LEDs due to wire deformation and/or breakage.

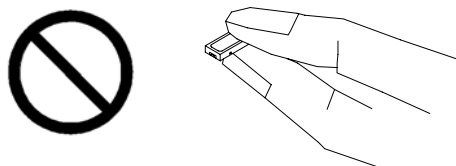

- Tweezers

Since silicone used as encapsulating resin in this product is a soft material, the upper surface of the product is soft. Pressuring onto the product might cause catastrophic failure of the LEDs due to damage to encapsulant (such as scratch, chip-out and delamination) and wire (such as deformation and breakage) and LED detachment.

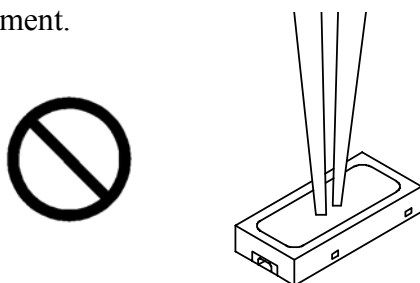

· Pick and Place

*Avoid direct contact to the encapsulant with the picking up nozzle.

Failure to comply might result in damage to encapsulant and in the worst cases, catastrophic failure of the LEDs due to wire deformation and/or breakage.

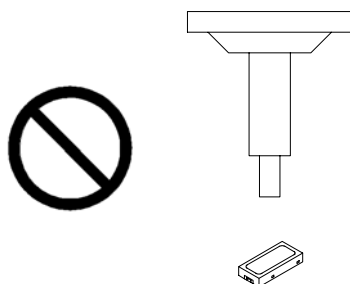

· Drop

Please note that a package damage such as crack might occur when having dropped the product.

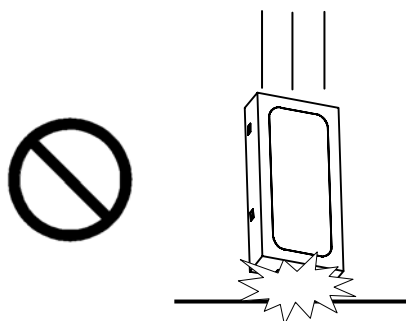

· Printed Circuit Board Assembled (PCB with LEDs soldered)

Do not stack assembled PCBs together. Since silicone is a soft material, abrasion between two PCB assembled with silicone encapsulated LED might cause catastrophic failure of the LEDs due to damage to encapsulant (such as scratch, chip-out and delamination) and wire (such as deformation and breakage) and LED detachment.

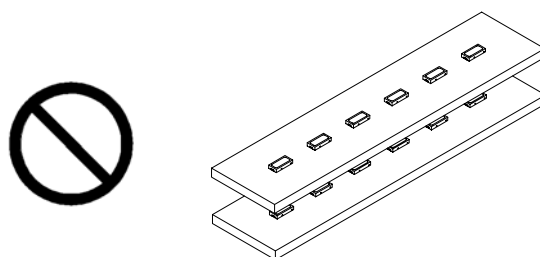

(6) Soldering Conditions

- The LEDs can be soldered in place using the reflow soldering method. Nichia cannot make a guarantee on the LEDs after they have been assembled using the dip soldering method.
- Recommended soldering conditions

	Reflow Soldering		Hand Soldering	
	Lead Solder	Lead-free Solder	Temperature	Soldering time
Pre-heat	120 ~ 150°C	180 ~ 200°C	350°C Max. 3 sec. Max. (one time only)	
Pre-heat time	120 sec. Max.	120 sec. Max.		
Peak temperature	240°C Max.	260°C Max.		
Soldering time	10 sec. Max.	10 sec. Max.		
Condition	refer to Temperature - profile ①.	refer to Temperature - profile ②. (N ₂ reflow is recommended.)		

* Although the recommended soldering conditions are specified in the above table, reflow or hand soldering at the lowest possible temperature is desirable for the LEDs.

* A rapid-rate process is not recommended for cooling the LEDs down from the peak temperature.

[Temperature-profile (Surface of circuit board)]

Use the conditions shown to the under figure.

<① : Lead Solder>

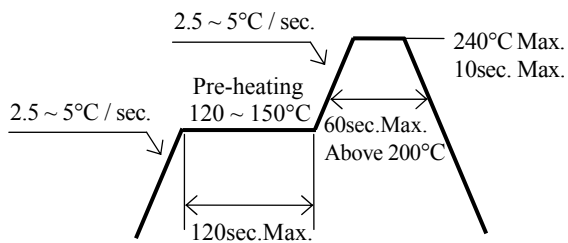

<② : Lead-free Solder>

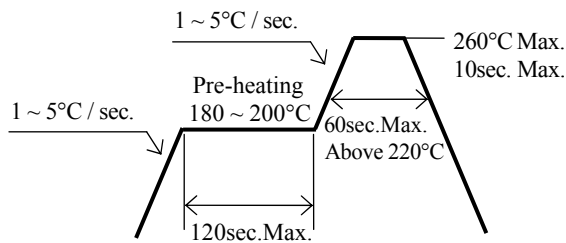

[Recommended soldering pad design]

Use the following conditions shown in the figure.

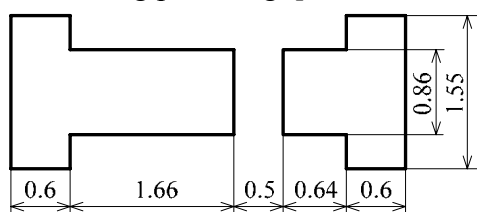

(Unit : mm)

[Recommended metal solder stencil aperture]

Use the following conditions shown in the figure.

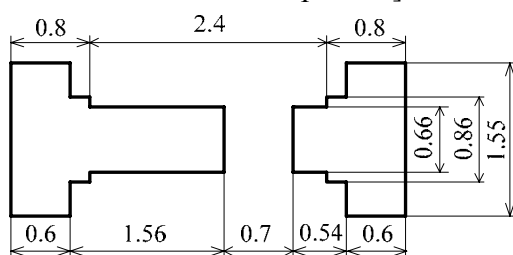

(Unit : mm)

- Occasionally there is a brightness decrease caused by the influence of heat or ambient atmosphere during air reflow. It is recommended that the customer use the nitrogen reflow method.
- Repairing should not be done after the LEDs have been soldered. When repairing is unavoidable, a double-head soldering iron should be used. It should be confirmed beforehand whether the characteristics of the LEDs will or will not be damaged by repairing.
- Reflow soldering should not be done more than two times.
- When soldering, do not put stress on the LEDs during heating.

(7) Cleaning

- It is recommended that isopropyl alcohol be used as a solvent for cleaning the LEDs. When using other solvents, it should be confirmed beforehand whether the solvents will dissolve the package and the resin or not. Freon solvents should not be used to clean the LEDs because of worldwide regulations.
- Do not clean the LEDs by the ultrasonic. When it is absolutely necessary, the influence of ultrasonic cleaning on the LEDs depends on factors such as ultrasonic power and the assembled condition. Before cleaning, a pre-test should be done to confirm whether any damage to the LEDs will occur.

(8) Safety Guideline for Human Eyes

- The International Electrical Commission (IEC) published in 2006 IEC 62471:2006 *Photobiological safety of lamps and lamp systems* which includes LEDs within its scope. Meanwhile LEDs were removed from the scope of the IEC 60825-1:2007 laser safety standard, the 2001 edition of which included LED sources within its scope. However, keep in mind that some countries and regions have adopted standards based on the IEC laser safety standard IEC 60825-1:2001 which includes LEDs within its scope.

Following IEC 62471:2006, most of Nichia LEDs can be classified as belonging to either Exempt Group or Risk Group 1. Optical characteristics of a LED such as radiant flux, spectrum and light distribution are factors that affect the risk group determination of the LED. Especially a high-power LED, that emits light containing blue wavelengths, may be in Risk Group 2.

Great care should be taken when viewing directly the LED driven at high current or the LED with optical instruments, which may greatly increase the hazard to your eyes.

(9) Others

- NSSL157-H3 complies with RoHS Directive.
- Flashing lights have been known to cause discomfort in people; you can prevent this by taking precautions during use. Also, people should be cautious when using equipment that has had LEDs incorporated into it.
- The LEDs described in this brochure are intended to be used for ordinary electronic equipment (such as office equipment, communications equipment, measurement instruments and household appliances). Consult Nichia's sales staff in advance for information on the applications in which exceptional quality and reliability are required, particularly when the failure or malfunction of the LEDs may directly jeopardize life or health (such as for airplanes, aerospace, submersible repeaters, nuclear reactor control systems, automobiles, traffic control equipment, life support systems and safety devices).
- The customer shall not reverse engineer by disassembling or analysis of the LEDs without having prior written consent from Nichia. When defective LEDs are found, the customer shall inform Nichia directly before disassembling or analysis.
- The formal specifications must be exchanged and signed by both parties before large volume purchase begins.
- The appearance and specifications of the product may be modified for improvement without notice.

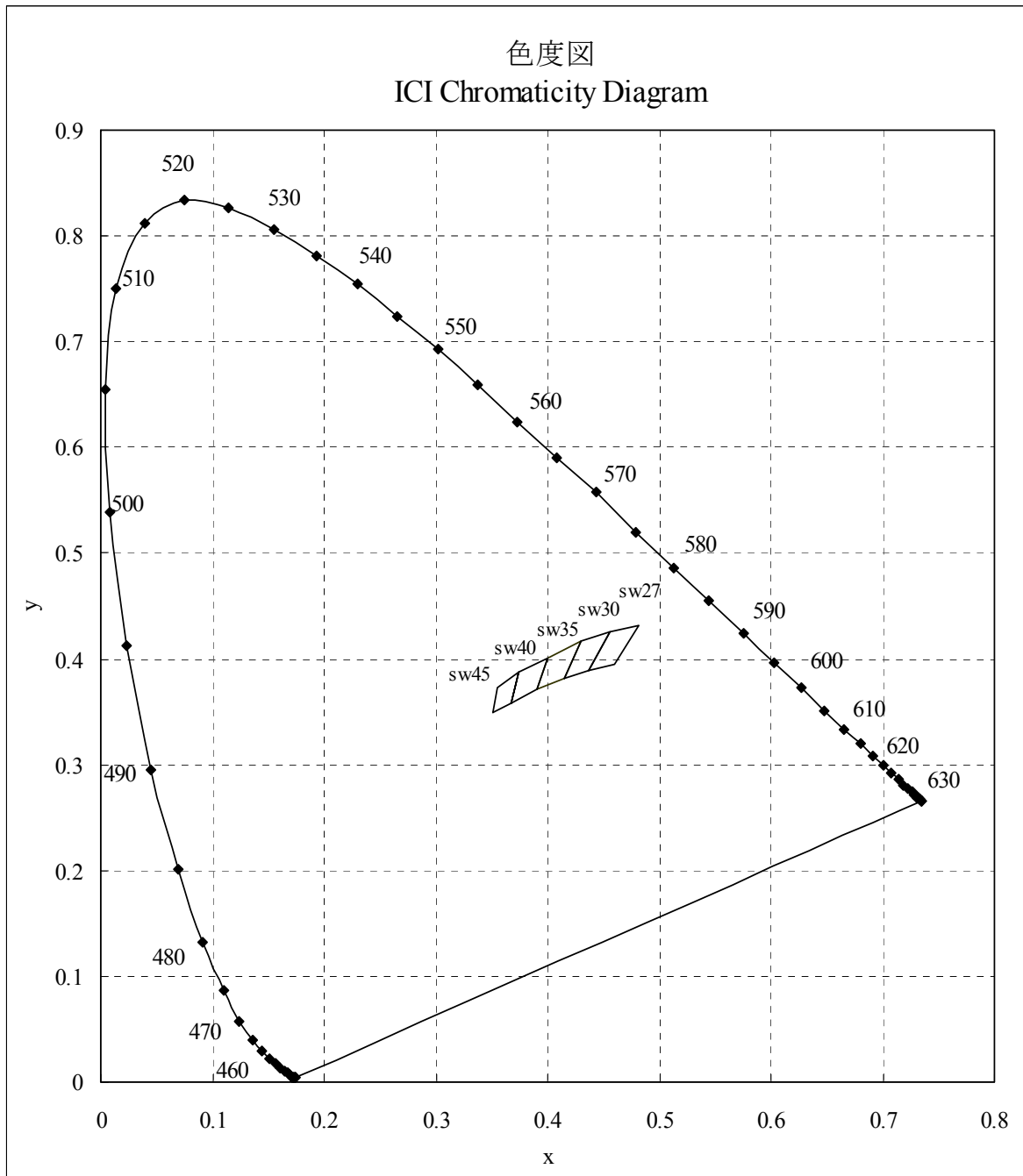

* Color Coordinates Measurement allowance is ± 0.005 .

■ 順電圧-順電流特性
Forward Voltage vs.
Forward Current

Ta=25°C

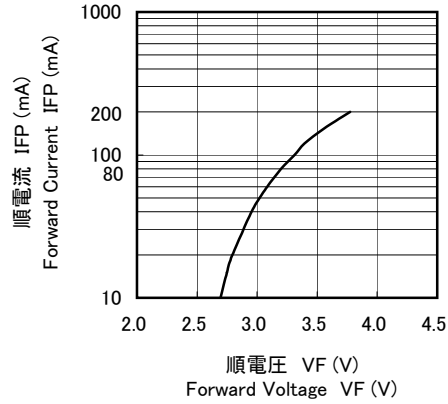

■ 順電流-相対光束特性
Forward Current vs.
Relative Luminous Flux

Ta=25°C

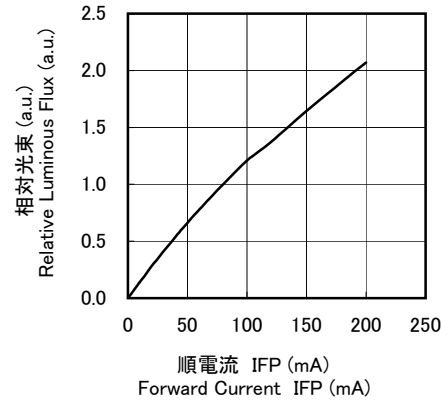

■ デューティー比-許容順電流特性
Duty Ratio vs.
Allowable Forward Current

Ta=25°C

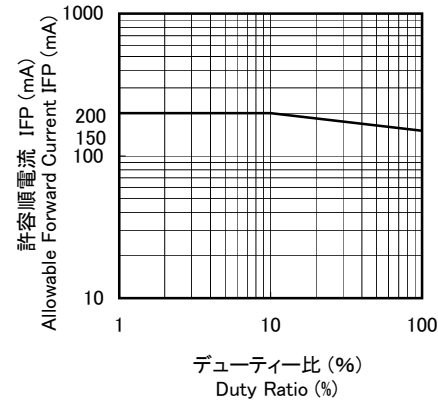

■ 周囲温度-順電圧特性
Ambient Temperature vs.
Forward Voltage

IFP=80mA

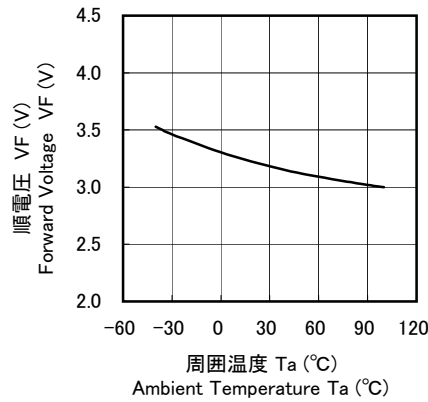

■ 周囲温度-相対光束特性
Ambient Temperature vs.
Relative Luminous Flux

IFP=80mA

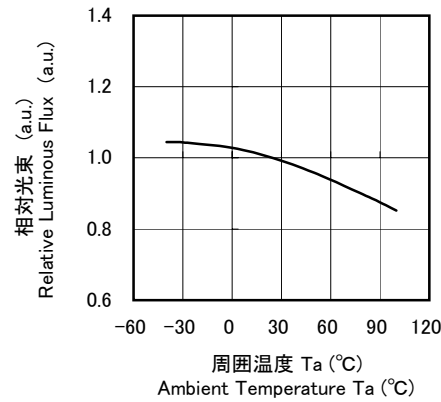

■ 周囲温度-許容順電流特性
Ambient Temperature vs.
Allowable Forward Current

Rja=120°C/W

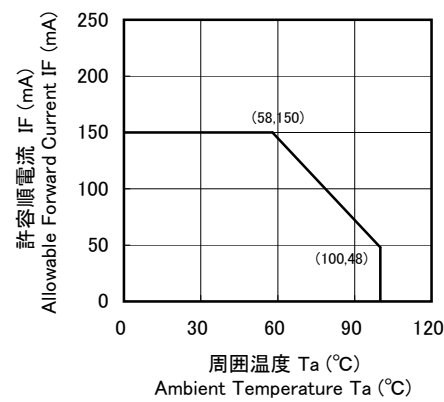

■ カソード側はんだ接合部温度-許容順電流特性
Solder Temperature (Cathode Side) vs.
Allowable Forward Current

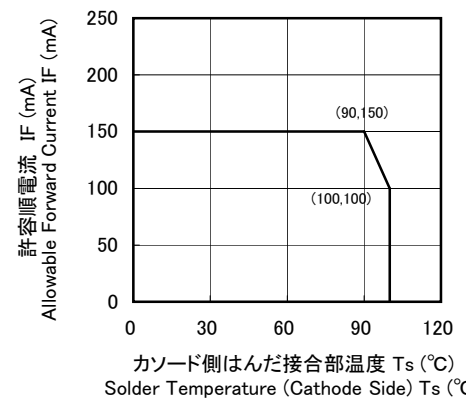

型名 Model NSSL157-H3	名称 Title 初期電気/光学特性 CHARACTERISTICS
日亜化学工業 (株) NICHIA CORPORATION	管理番号 No. 100408 058361

■ 順電流-色度特性

Forward Current vs.
Chromaticity Coordinate

Ta=25°C

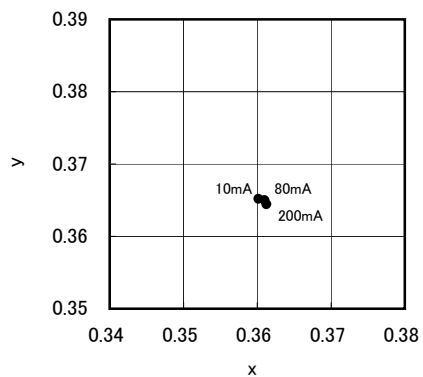

* ランク Rank sw40,sw45

■ 発光スペクトル
Spectrum

Ta=25°C
If=80mA

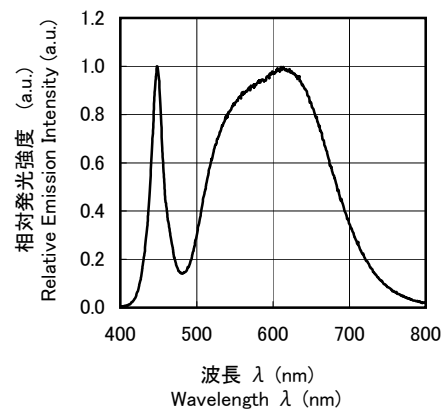

■ 周囲温度-色度特性

Ambient Temperature vs.
Chromaticity Coordinate

IfP=80mA

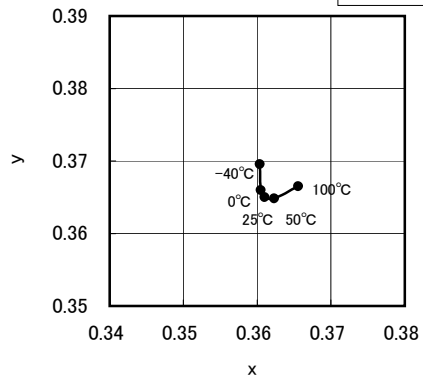

* ランク Rank sw40,sw45

Ta=25°C

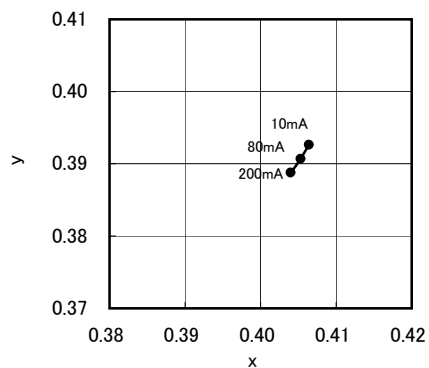

* ランク Rank sw27,sw30,sw35

IfP=80mA

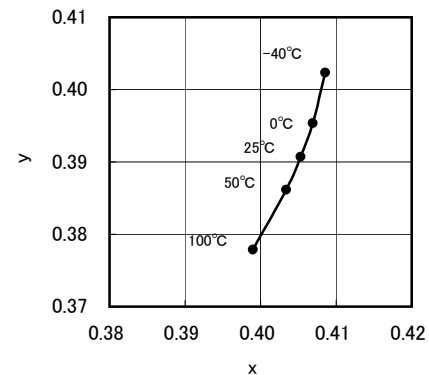

* ランク Rank sw27,sw30,sw35

■ 指向特性
Directivity

Ta=25°C
IfP=80mA

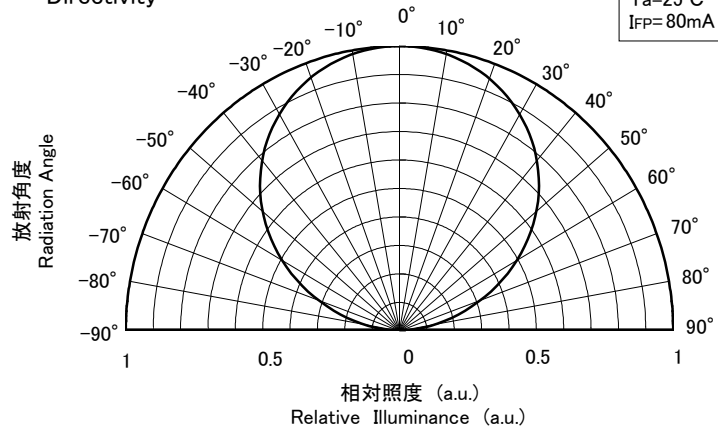

型名 Model NSSL157-H3	名称 Title 初期電気/光学特性 CHARACTERISTICS
日亜化学工業 (株) NICHIA CORPORATION	管理番号 No. 100408058371

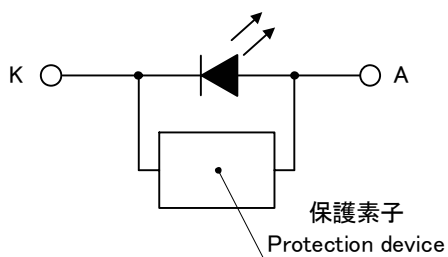
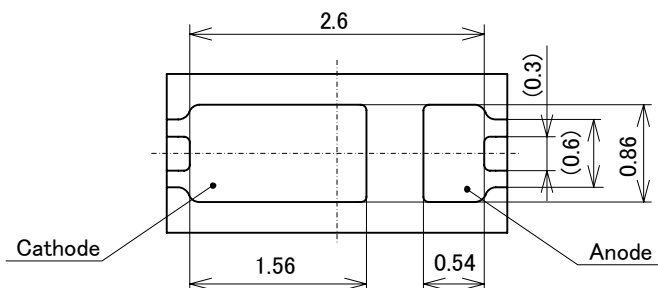
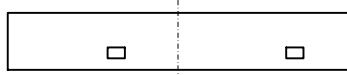
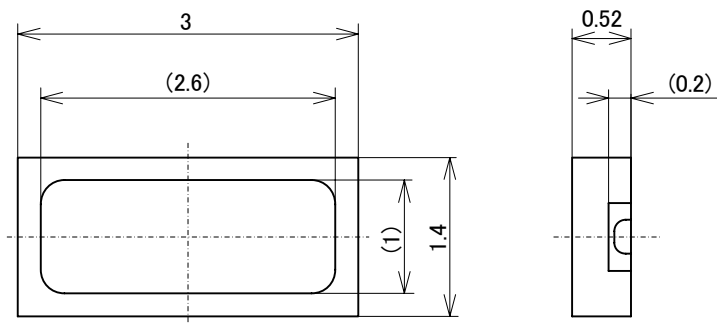

項目 Item	材質 Materials
パッケージ材質 Package	耐熱性ポリマー Heat-Resistant Polymer
封止樹脂 Encapsulating Resin	シリコン樹脂 (拡散剤+蛍光体入り) Silicone Resin (with Diffused + Phosphor)
電極 Electrodes	銅合金+銀メッキ Ag Plating Copper Alloy

- (注1) バリは寸法に含まないものとします。
 (NOTE1) The LED may have flash/flange which exceeds the tolerance of this print.
- (注2) 本製品には静電気に対する保護素子が内蔵されています。
 (NOTE2) NSSL157-H3 has a protection device built in as a protection circuit against static electricity.

型名 Model NSSL157-H3	名称 Title 外形寸法図 OUTLINE DIMENSIONS	単位 Unit mm
日亜化学工業 (株) NICHIA CORPORATION	管理番号 No. 100412058601	公差 Allow ±0.2

テーピング部 Taping part

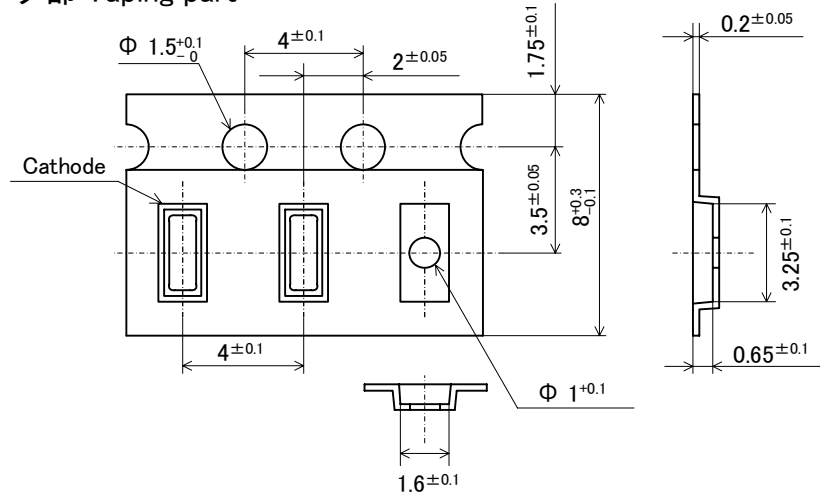

リール部 Reel part

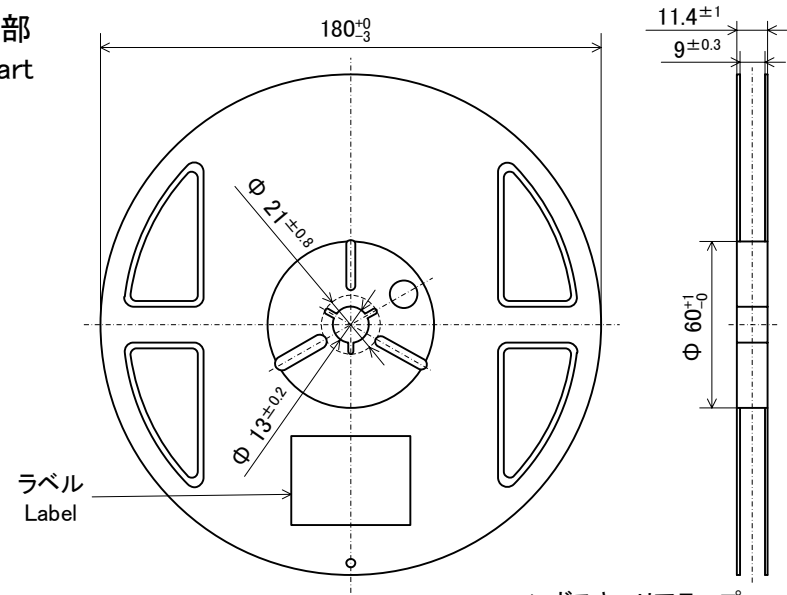

トレーラ部/リーダ部 Trailer Part/Leader Part

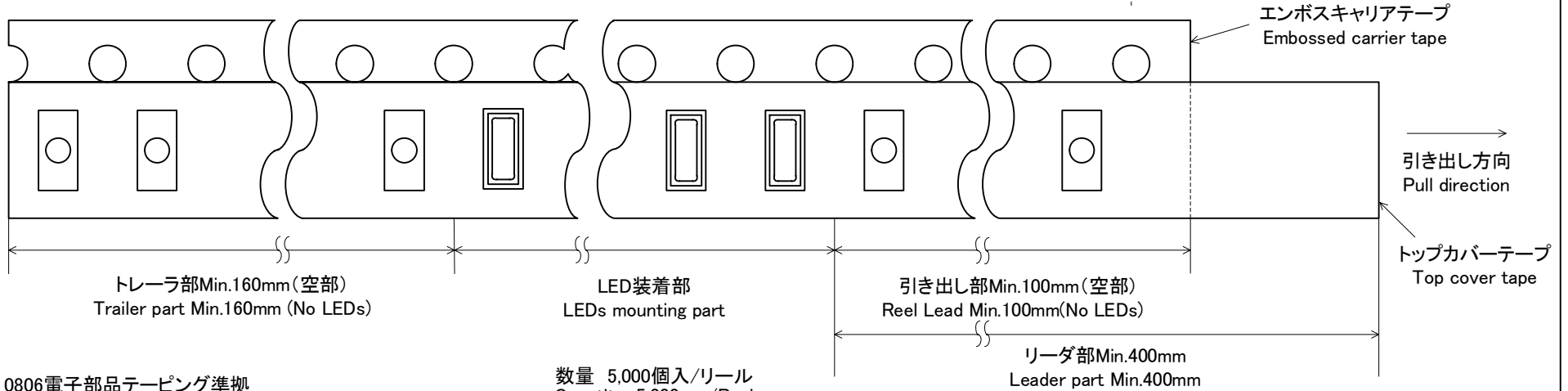

JIS C 0806電子部品テーピング準拠
Taping is based on the JIS C 0806 : Packaging of Electronic Components on Continuous Tapes.

数量 5,000個入/リール
Quantity 5,000pcs/Reel

型名 Model NxxL157xT-H3	名称 Title テーピング仕様図 TAPING DIMENSIONS	単位 Unit mm
日亜化学工業 (株) NICHIA CORPORATION	管理番号 No. 100405058191	

シリカゲルとともにリールをアルミ防湿袋に入れ、熱シールにより封をする。

The reel and moisture absorbent material are put in the moisture proof foil bag and then heat sealed.

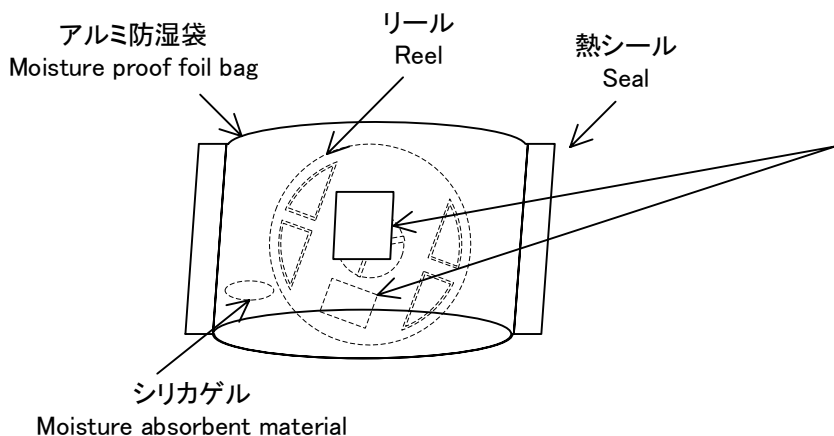

ラベル Label



ダンボールで仕切りをする

The box is partitioned with the cardboard.

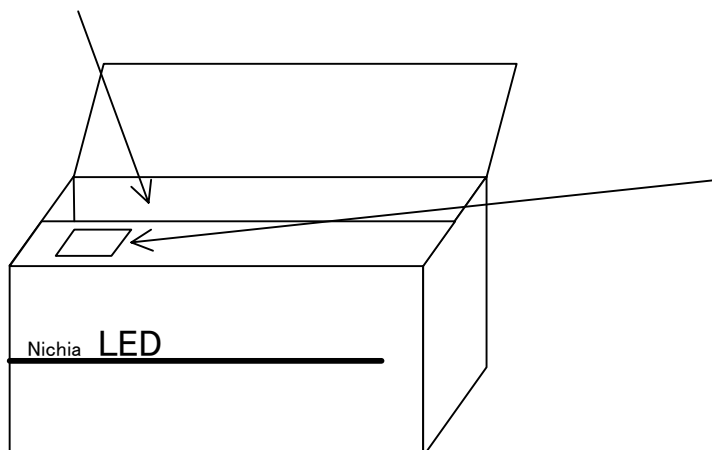

ラベル Label



基本梱包単位 Packing Unit

	リール数 Reel/bag	チップ个数 Quantity/bag(pcs)
アルミ防湿袋 Moisture proof foil bag	1reel	5,000 MAX.

梱包箱(段ボール) Cardbord box	箱の寸法 Dimensions(mm)	リール数 Reel/box	チップ个数 Quantity/box(pcs)
S	291 × 237 × 120 × 8t	7reel MAX.	35,000 MAX.
M	259 × 247 × 243 × 5t	15reel MAX.	75,000 MAX.
L	444 × 262 × 259 × 8t	30reel MAX.	150,000 MAX.

型名 Model NxxL157xT-H3	名称 Title 梱包仕様図 PACKING
日亜化学工業 (株) NICHIA CORPORATION	管理番号 No. 100405058201