

LC 3 mm (T1) LED, Diffused Low Current LED

LS 3369, LY 3369, LG 3369

Besondere Merkmale

- eingefärbtes, diffuses Gehäuse
- als optischer Indikator einsetzbar
- hohe Lichtstärke bei kleinen Strömen (typ. 2 mA)
- Lötspieße mit Aufsetzebene
- gegurtet lieferbar
- Störimpulsfest nach DIN 40839

Features

- colored, diffused package
- for use as optical indicator
- high luminous intensity at low currents (typ. 2 mA)
- solder leads with stand-off
- available taped on reel
- load dump resistant acc. to DIN 40839

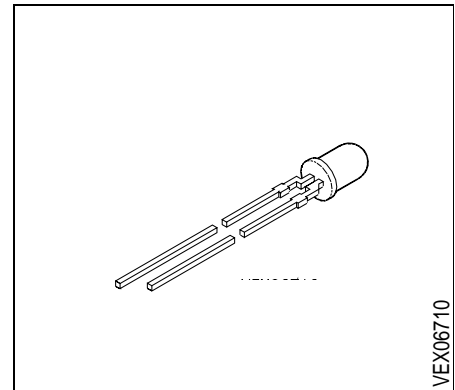

| Typ Type | Emissionsfarbe Color of Emission | Gehäusefarbe Color of Package | Lichtstärke Luminous Intensity $I_F = 2 \text{ mA}$ $I_V \text{ (mcd)}$ | Bestellnummer Ordering Code |
|-------------|--|-------------------------------------|---|--------------------------------|
| LS 3369-EH | super-red | red diffused | 0.63 ... 5.0 | Q62703-Q1748 |
| LS 3369-G | | | 1.60 ... 3.2 | Q62703-Q2068 |
| LS 3369-H | | | 2.50 ... 5.0 | Q62703-Q3820 |
| LS 3369-GK | | | 1.60 ... 12.5 | Q62703-Q3821 |
| LY 3369-EH | yellow | yellow diffused | 0.63 ... 5.0 | Q62703-Q1749 |
| LY 3369-F | | | 1.00 ... 2.0 | Q62703-Q2030 |
| LY 3369-G | | | 1.60 ... 3.2 | Q62703-Q2029 |
| LY 3369-H | | | 2.50 ... 5.0 | Q62703-Q1906 |
| LY 3369-FJ | | | 1.00 ... 8.0 | Q62703-Q3822 |
| LG 3369-EH | green | green diffused | 0.63 ... 5.0 | Q62703-Q1750 |
| LG 3369-F | | | 1.00 ... 2.0 | Q62703-Q2069 |
| LG 3369-G | | | 1.60 ... 3.2 | Q62703-Q2070 |
| LG 3369-FJ | | | 1.00 ... 8.0 | Q62703-Q3823 |

Streuung der Lichterstärke in einer Verpackungseinheit $I_{V \max} / I_{V \min} \leq 2.0$.

Luminous intensity ratio in one packaging unit $I_{V \max} / I_{V \min} \leq 2.0$.

Grenzwerte
Maximum Ratings

| Bezeichnung Parameter | Symbol Symbol | Werte Values | Einheit Unit |
|--|------------------|-----------------|-----------------|
| Betriebstemperatur Operating temperature range | T_{op} | - 55 ... + 100 | °C |
| Lagertemperatur Storage temperature range | T_{stg} | - 55 ... + 100 | °C |
| Sperrschichttemperatur Junction temperature | T_j | + 100 | °C |
| Durchlaßstrom Forward current | I_F | 7.5 | mA |
| Stoßstrom Surge current $t \leq 10 \mu s, D = 0.005$ | I_{FM} | 0.15 | A |
| Sperrspannung Reverse voltage | V_R | 5 | V |
| Verlustleistung Power dissipation $T_A \leq 25 \text{ °C}$ | P_{tot} | 20 | mW |
| Wärmewiderstand Thermal resistance Sperrschicht / Luft Junction / air | $R_{th JA}$ | 500 | K/W |

Kennwerte ($T_A = 25\text{ °C}$)

Characteristics

| Bezeichnung Parameter | Symbol Symbol | Werte Values | | | Einheit Unit |
|---|-------------------------|-----------------|------------|------------|--------------------------------|
| | | LS | LY | LG | |
| Wellenlänge des emittierten Lichtes(typ.) Wavelength at peak emission(typ.) $I_F = 7.5\text{ mA}$ | λ_{peak} | 635 | 586 | 565 | nm |
| Dominantwellenlänge(typ.) Dominant wavelength(typ.) $I_F = 7.5\text{ mA}$ | λ_{dom} | 628 | 590 | 570 | nm |
| Spektrale Bandbreite bei 50 % $I_{\text{rel max}}$ (typ.) Spectral bandwidth at 50 % $I_{\text{rel max}}$ (typ.) $I_F = 7.5\text{ mA}$ | $\Delta\lambda$ | 45 | 45 | 25 | nm |
| Abstrahlwinkel bei 50 % I_V (Vollwinkel) Viewing angle at 50 % I_V | 2ϕ | 60 | 60 | 60 | Grad deg. |
| Durchlaßspannung(typ.) Forward voltage(max.) $I_F = 2\text{ mA}$ | V_F V_F | 1.8 2.6 | 2.0 2.7 | 1.9 2.6 | V V |
| Sperrstrom(typ.) Reverse current(max.) $V_R = 5\text{ V}$ | I_R I_R | 0.01 10 | 0.01 10 | 0.01 10 | μA μA |
| Kapazität(typ.) Capacitance $V_R = 0\text{ V}, f = 1\text{ MHz}$ | C_0 | 3 | 3 | 15 | pF |
| Schaltzeiten: Switching times: I_V from 10 % to 90 % (typ.) I_V from 90 % to 10 % (typ.) $I_F = 100\text{ mA}, t_p = 10\text{ }\mu\text{s}, R_L = 50\text{ }\Omega$ | t_r t_f | 200 150 | 200 150 | 450 200 | ns ns |

Relative spektrale Emission $I_{rel} = f(\lambda)$, $T_A = 25\text{ °C}$, $I_F = 7.5\text{ mA}$

Relative spectral emission

$V(\lambda)$ = spektrale Augenempfindlichkeit

Standard eye response curve

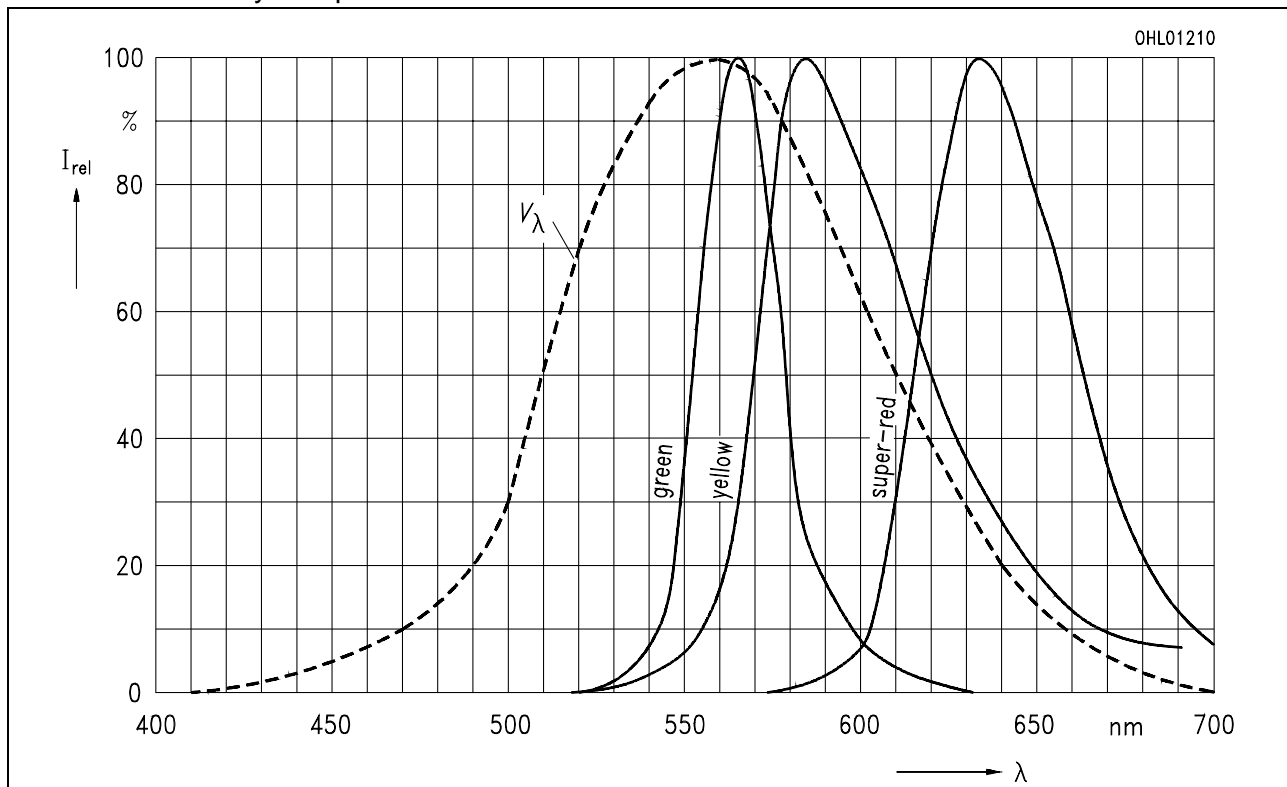

Abstrahlcharakteristik $I_{rel} = f(\varphi)$

Radiation characteristic

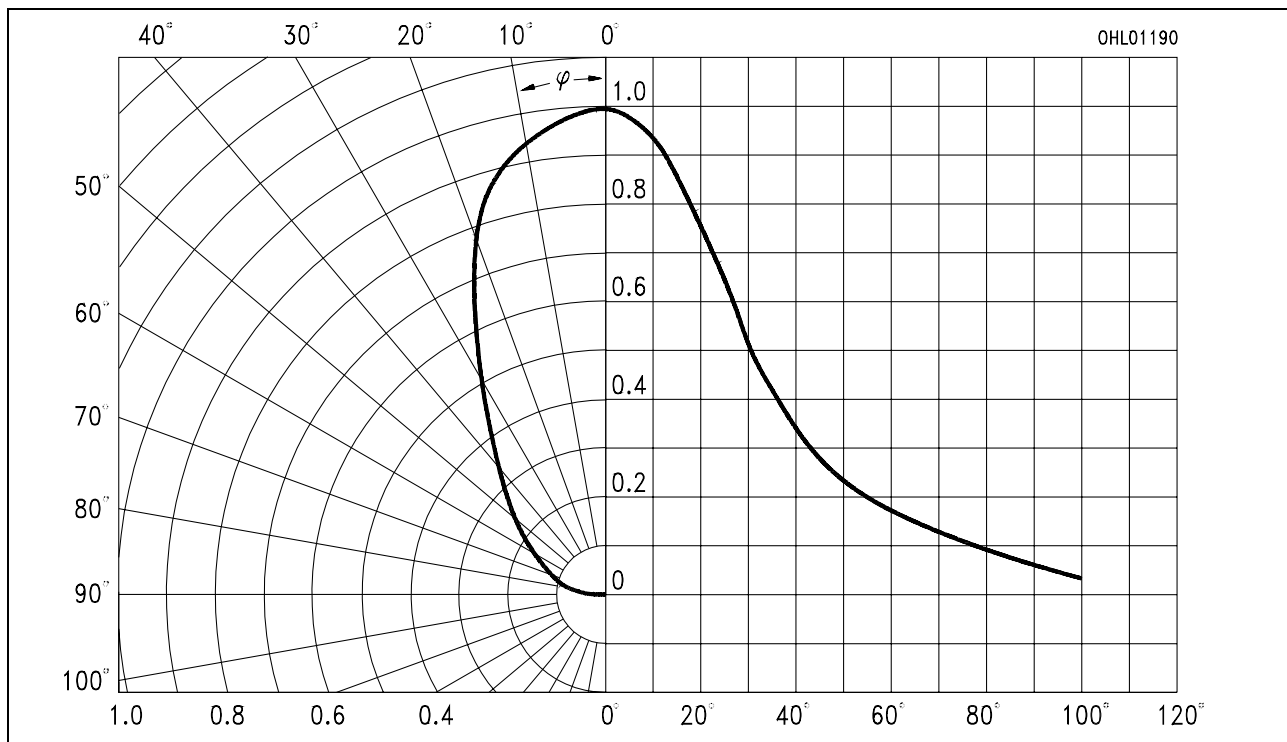

Durchlaßstrom $I_F = f(V_F)$

Forward current

$T_A = 25^\circ\text{C}$

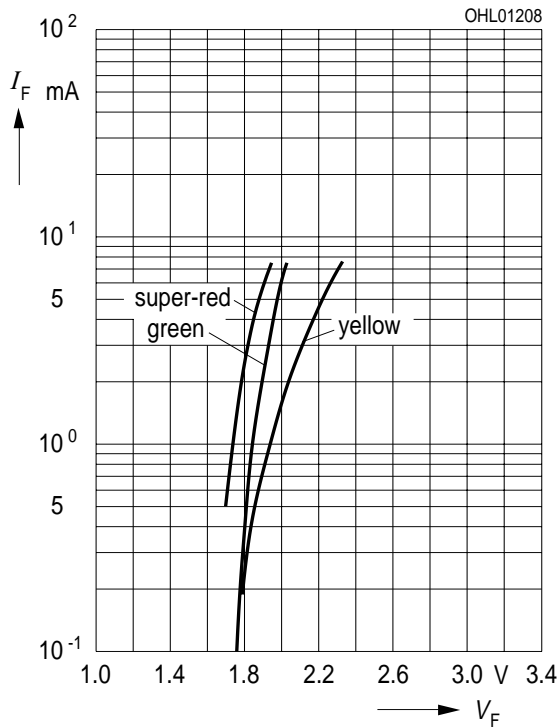

Relative Lichtstärke $I_V/I_{V(2\text{mA})} = f(I_F)$

Relative luminous intensity

$T_A = 25^\circ\text{C}$

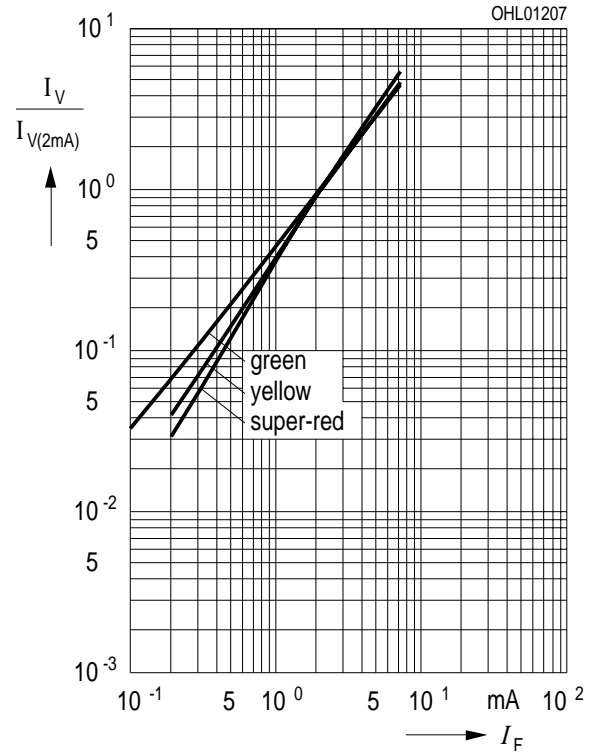

Zulässige Impulsbelastbarkeit $I_F = f(t_p)$

Permissible pulse handling capability

Duty cycle $D =$ parameter, $T_A = 25^\circ\text{C}$

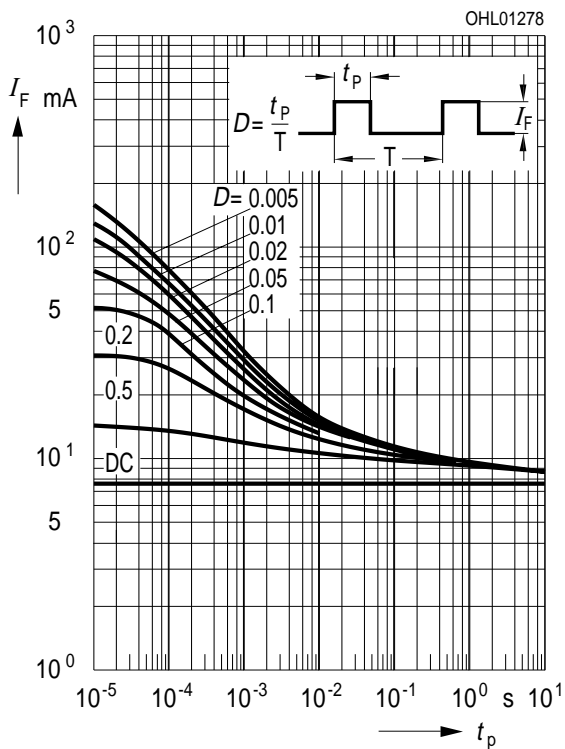

Maximal zulässiger Durchlaßstrom

Max. permissible forward current

$I_F = f(T_A)$

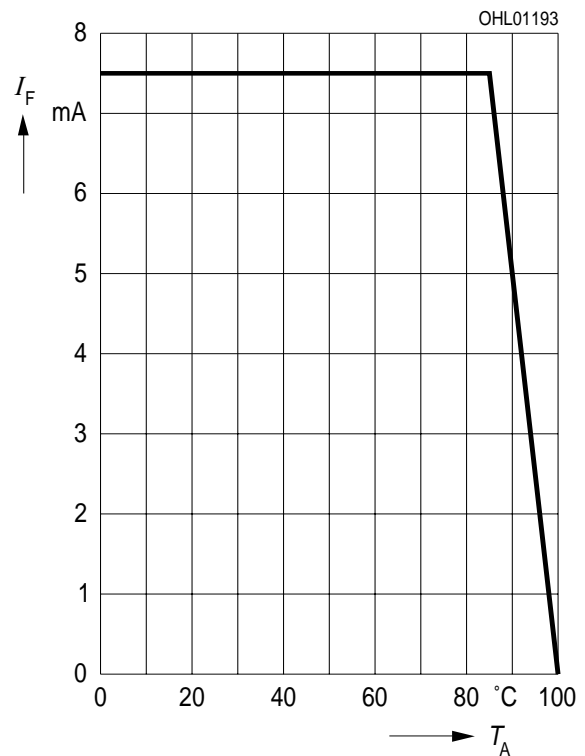

Wellenlänge der Strahlung $\lambda_{\text{peak}} = f(T_A)$
Wavelength at peak emission

$I_F = 7.5 \text{ mA}$

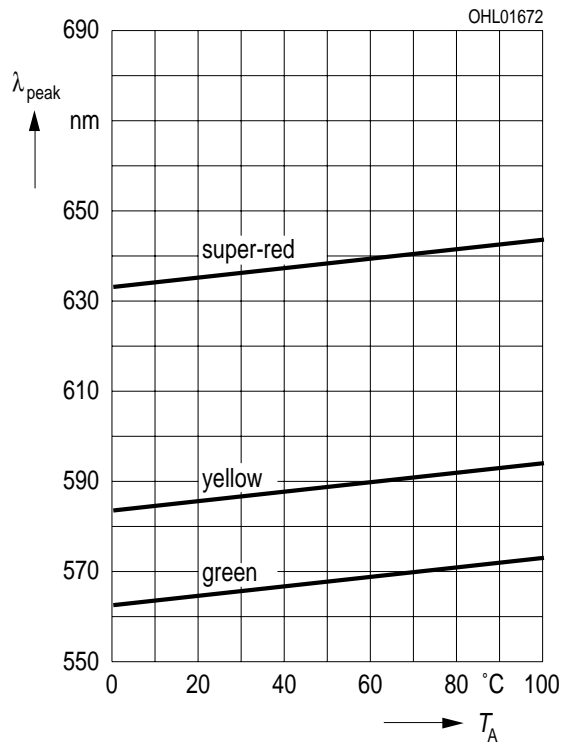

Dominantwellenlänge $\lambda_{\text{dom}} = f(T_A)$
Dominant wavelength

$I_F = 7.5 \text{ mA}$

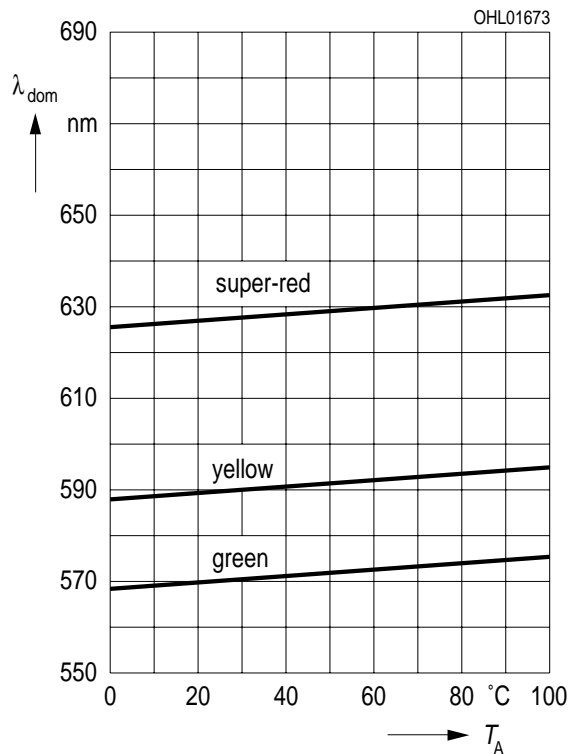

Durchlaßspannung $V_F = f(T_A)$
Forward voltage

$I_F = 2 \text{ mA}$

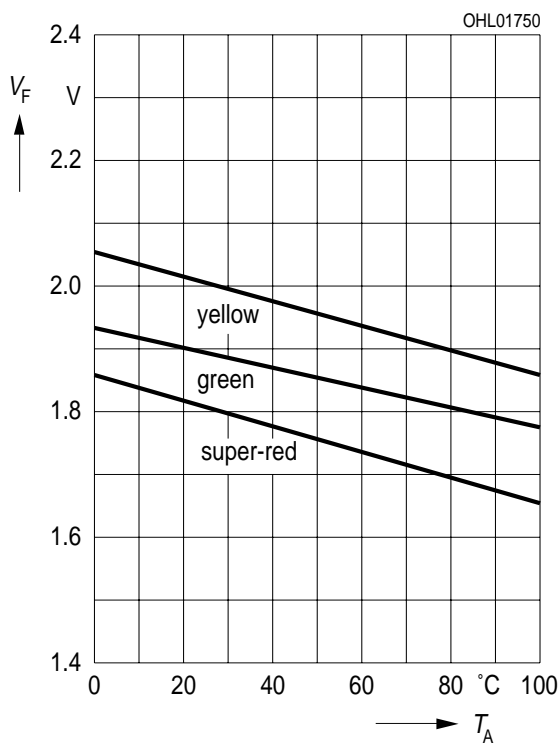

Relative Lichtstärke $I_V/I_{V(25^\circ\text{C})} = f(T_A)$
Relative luminous intensity

$I_F = 2 \text{ mA}$

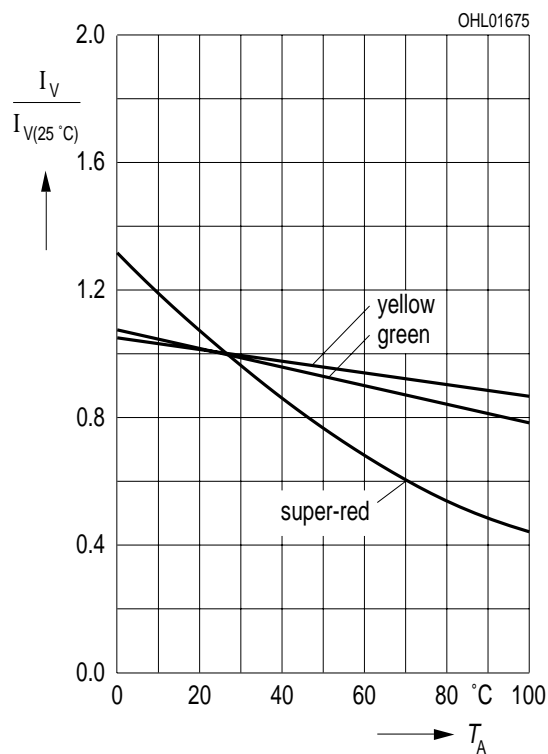

Maßzeichnung (Maße in mm, wenn nicht anders angegeben)
Package Outlines (Dimensions in mm, unless otherwise specified)

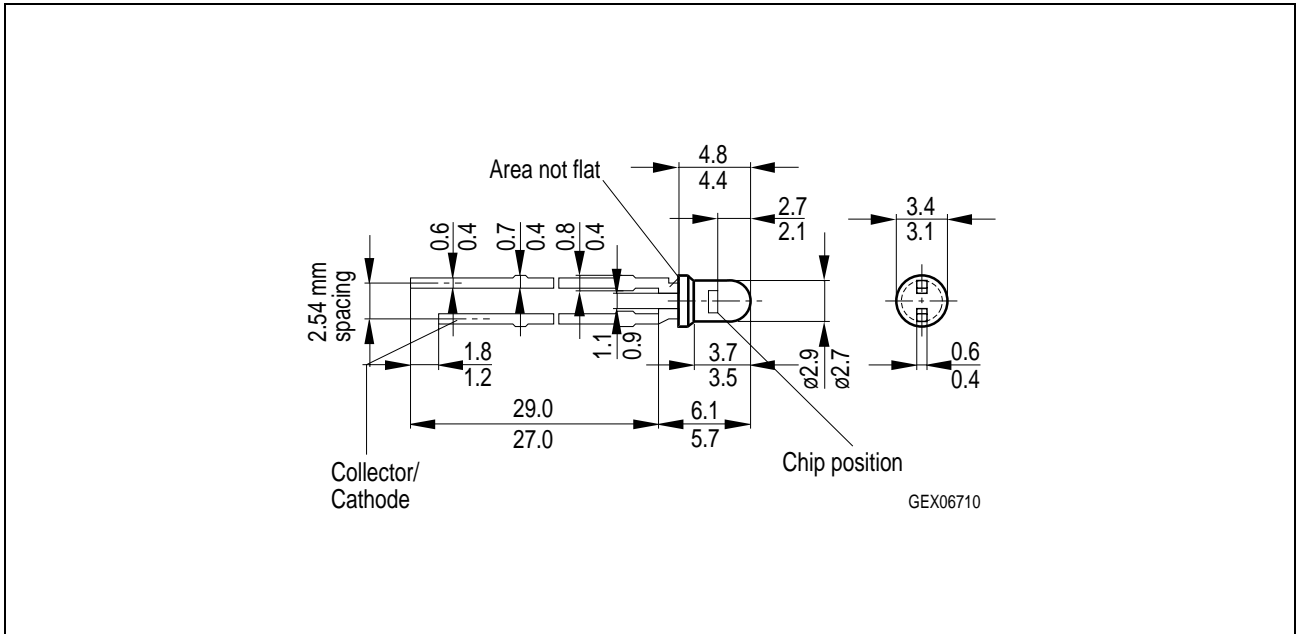

Kathodenkennzeichnung: Kürzerer Lötspieß
Cathode mark: Short solder lead