

Hyper Multi TOPLED® Hyper-Bright LED

LATB T686



**Non-RoHS compliant version of product will be discontinued acc. to OS-PD-2005-005.
The product itself will remain within RoHS compliant version.**

Besondere Merkmale

- **Gehäusetyp:** weißes P-LCC-4 Gehäuse; Kontrasterhöhung durch schwarze Oberfläche (RGB-Displays)
- **Besonderheit des Bauteils:** additive Farbmischung durch unabhängige Ansteuerung aller Chips
- **Wellenlänge:** 617 nm (amber), 528 nm (true green), 465 nm (blau)
- **Abstrahlwinkel:** Lambertscher Strahler (120°)
- **Technologie:** InGaAlP (amber), InGaN (true green), GaN (blau)
- **optischer Wirkungsgrad:** 11 lm/W (amber), 8 lm/W (true green), 1 lm/W (blau)
- **Gruppierungsparameter:** Lichtstärke
- **Verarbeitungsmethode:** für alle SMT-Bestücktechniken geeignet
- **Lötmethode:** IR Reflow Löten und Wellenlöten (TTW)
- **Vorbehandlung:** nach JEDEC Level 2
- **Gurtung:** 8-mm Gurt mit 2000/Rolle, ø180 mm oder 8000/Rolle, ø330 mm
- **ESD-Festigkeit:** ESD-sicher bis 2 kV nach JESD22-A114-B

Anwendungen

- Anzeigen im Innen- und Außenbereich (z.B. Grafikdisplays)
- Leuchtdiodenchips getrennt ansteuerbar
- Vollfarbdisplays bzw. RGB-Displays
- Hinterleuchtung (LCD, Schalter, Tasten, Displays, Werbebeleuchtung, Allgemeinbeleuchtung)
- Einkopplung in Lichtleiter

Features

- **package:** white P-LCC-4 package; higher contrast by a black surface (RGB-Displays)
- **feature of the device:** additive mixture of color stimuli by independent driving of each chip
- **wavelength:** 617 nm (amber), 528 nm (true green), 465 nm (blue)
- **viewing angle:** Lambertian Emitter (120°)
- **technology:** InGaAlP (amber), InGaN (true green), GaN (blue)
- **optical efficiency:** 11 lm/W (amber), 8 lm/W (true green), 1 lm/W (blue)
- **grouping parameter:** luminous intensity
- **assembly methods:** suitable for all SMT assembly methods
- **soldering methods:** IR reflow soldering and TTW soldering
- **preconditioning:** acc. to JEDEC Level 2
- **taping:** 8 mm tape with 2000/reel, ø180 mm or 8000/reel, ø330 mm
- **ESD-withstand voltage:** up to 2 kV acc. to JESD22-A114-B

Applications

- indoor and outdoor displays (e.g. graphic displays)
- LED chips can be controlled separately
- full color displays, RGB-Displays
- backlighting (LCD, switches, keys, displays, illuminated advertising, general lighting)
- coupling into light guides

Bestellinformation
Ordering Information

Typ Type	Emissionsfarbe Color of Emission	Lichtstärke ¹⁾ Seite 20 Luminous Intensity ¹⁾ page 20 $I_F = 20 \text{ mA}$ $I_V \text{ (mcd)}$		
		amber	true green	blue
LATB T686	amber true green blue	71 ... 180	112 ... 280	7.1 ... 18.0

Bestellinformation
Ordering Information

Typ Type	Bestellnummer Ordering Code
LATB T686-QR-1+RS-78+KL-1	Q62703Q5759

Anm.: -78 Gesamter Farbbereich, Lieferung in Einzelgruppen (siehe Seite 5)

Note: -78 Total color tolerance range, delivery in single groups (see page 5)

Grenzwerte
Maximum Ratings

Bezeichnung Parameter	Symbol Symbol	Werte Values			Einheit Unit
		amber	true green	blue	
Betriebstemperatur Operating temperature range	T_{op}	- 40 ... + 100			°C
Lagertemperatur Storage temperature range	T_{stg}	- 40 ... + 100			°C
Sperrschichttemperatur Junction temperature	T_j	+ 125	+ 125	+ 100	°C
Durchlassstrom Forward current ($T_A=25^\circ\text{C}$)	I_F	30	20	20	mA
Stoßstrom Surge current $t_p = 10 \mu\text{s}$, $D = 0.005$, $T_A=25^\circ\text{C}$	I_{FM}	1.00	0.25	0.20	A
Sperrspannung ^{2) Seite 20} Reverse voltage ^{2) page 20} ($T_A=25^\circ\text{C}$)	V_R	12	5	5	V
Leistungsaufnahme Power consumption ($T_A=25^\circ\text{C}$)	P_{tot}	80	85	90	mW
Wärmewiderstand Thermal resistance					
Sperrschicht/Umgebung ^{3) Seite 20} Junction/ambient ^{3) page 20}	1 chip on $R_{th JA}$	580	480	580	K/W
	3 chips on $R_{th JA}$	825	770	825	K/W
Sperrschicht/Lötpad Junction/solder point	1 chip on $R_{th JS}$	340	260	340	K/W
	3 chips on $R_{th JS}$	490	420	490	K/W

Kennwerte
Characteristics
 $(T_A = 25\text{ °C})$

Bezeichnung Parameter	Symbol Symbol	Werte Values			Einheit Unit
		amber	true green	blue	
Wellenlänge des emittierten Lichtes (typ.) Wavelength at peak emission $I_F = 20\text{ mA}$	λ_{peak}	622	523	428	nm
Dominantwellenlänge ^{4) Seite 20} Dominant wavelength ^{4) page 20} $I_F = 20\text{ mA}$	λ_{dom}	617 ± 5	528* ± 9	465 ± 5	nm
Spektrale Bandbreite bei 50 % $I_{\text{rel max}}$ (typ.) Spectral bandwidth at 50 % $I_{\text{rel max}}$ $I_F = 20\text{ mA}$	$\Delta\lambda$	16	33	60	nm
Abstrahlwinkel bei 50 % I_V (Vollwinkel) (typ.) Viewing angle at 50 % I_V	2ϕ	120	120	120	Grad deg.
Durchlassspannung ^{5) Seite 20} (typ.) Forward voltage ^{5) page 20} (max.) $I_F = 20\text{ mA}$	V_F V_F	2.0 2.4	3.2 3.9	3.8 4.1	V V
Sperrstrom (typ.) Reverse current (max.) $V_R = 5\text{ V}$ (blue / true green); 12 V (amber)	I_R I_R	0.01 10	0.01 10	0.01 10	μA μA
Temperaturkoeffizient von λ_{peak} (typ.) Temperature coefficient of λ_{peak} $I_F = 20\text{ mA}$; $-10\text{ °C} \leq T \leq 100\text{ °C}$	$TC_{\lambda_{\text{peak}}}$	0.13	0.04	0.004	nm/K
Temperaturkoeffizient von λ_{dom} (typ.) Temperature coefficient of λ_{dom} $I_F = 20\text{ mA}$; $-10\text{ °C} \leq T \leq 100\text{ °C}$	$TC_{\lambda_{\text{dom}}}$	0.06	0.03	0.03	nm/K
Temperaturkoeffizient von V_F (typ.) Temperature coefficient of V_F $I_F = 20\text{ mA}$; $-10\text{ °C} \leq T \leq 100\text{ °C}$	TC_V	- 1.8	- 3.6	- 3.1	mV/K
Optischer Wirkungsgrad (typ.) Optical efficiency $I_F = 20\text{ mA}$	η_{opt}	11	8	1	lm/W

* Einzelgruppen siehe Seite 5
Individual groups on page 5

Wellenlängengruppen (Dominantwellenlänge)⁴⁾ Seite 20
Wavelength Groups (Dominant Wavelength)⁴⁾ page 20

Gruppe Group	true green		Einheit Unit
	min.	max.	
7	519	528	nm
8	528	537	nm

Helligkeits-Gruppierungsschema
Brightness Groups

Helligkeitsgruppe Brightness Group	Lichtstärke ¹⁾ Seite 20 Luminous Intensity ¹⁾ page 20	Lichtstrom ⁶⁾ Seite 20 Luminous Flux ⁶⁾ page 20
	I _v (mcd)	Φ _v (lm)
K	7.1 ... 11.2	27 (typ.)
L	11.2 ... 18.0	45 (typ.)
M	18.0 ... 28.0	68 (typ.)
N	28.0 ... 45.0	110 (typ.)
P	45.0 ... 71.0	170 (typ.)
Q	71.0 ... 112.0	270 (typ.)
R	112.0 ... 180.0	430 (typ.)
S	180.0 ... 280.0	680 (typ.)

Anm.: Die Standardlieferform von Serientypen beinhaltet eine Familiengruppe. Einzelne Helligkeitsgruppen sind nicht bestellbar.

Note: The standard shipping format for serial types includes a family group. Individual brightness groups cannot be ordered.

Gruppenbezeichnung auf Etikett
Group Name on Label

Beispiel: R-1+S-7+K-1

Example: R-1+S-7+K-1

Helligkeitsgruppe Brightness Group (amber)	Wellenlänge (keine Gruppierung) Wavelength (no grouping) (amber)	Helligkeitsgruppe Brightness Group (true green)	Wellenlänge Wavelength (true green)	Helligkeitsgruppe Brightness Group (blue)	Wellenlänge (keine Gruppierung) Wavelength (no grouping) (blue)
R	1	S	7	K	1

Anm.: In einer Verpackungseinheit / Gurt ist immer nur eine Helligkeitsgruppe pro Farbe enthalten.

Note: No packing unit / tape ever contains more than one brightness group per color.

Relative spektrale Emission⁶⁾ Seite 20

Relative Spectral Emission⁶⁾ page 20

$V(\lambda)$ = spektrale Augenempfindlichkeit / Standard eye response curve

$I_{rel} = f(\lambda); T_A = 25\text{ °C}; I_F = 20\text{ mA}$

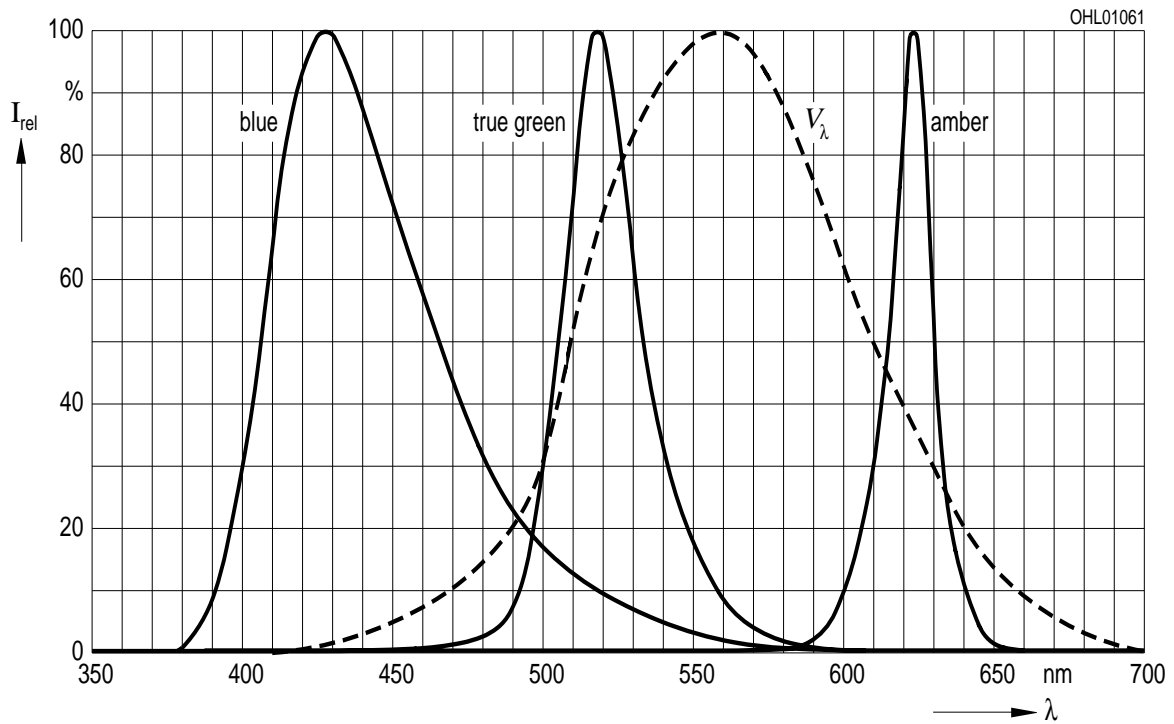

Abstrahlcharakteristik⁶⁾ Seite 20

Radiation Characteristic⁶⁾ page 20

$I_{rel} = f(\varphi); T_A = 25\text{ °C}$

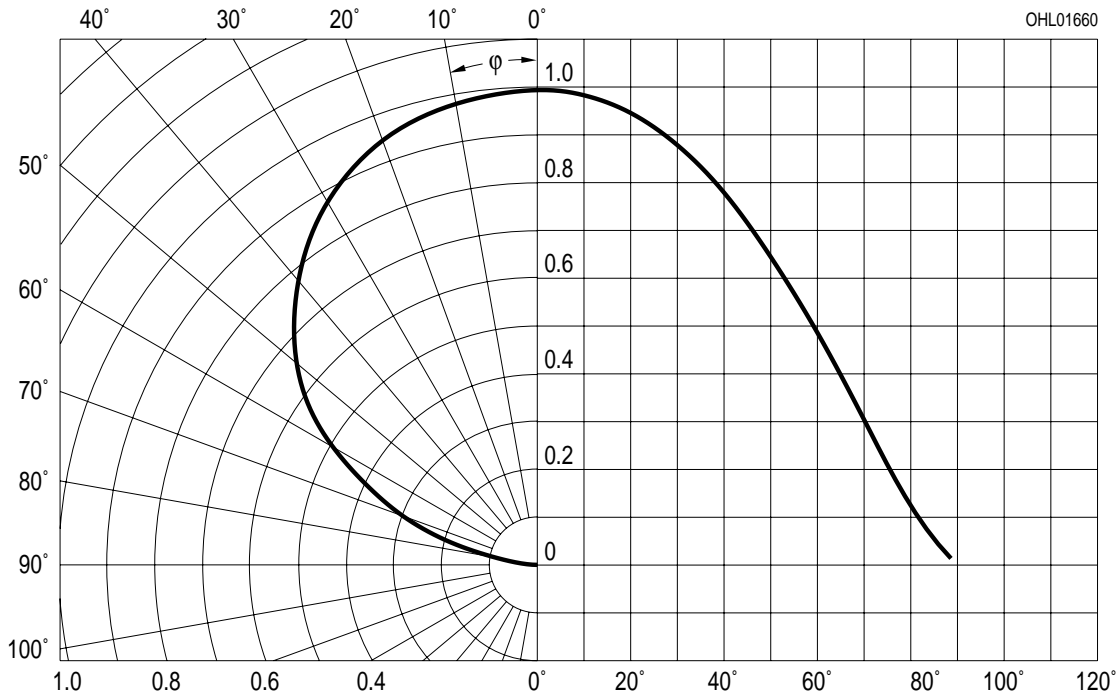

Durchlassstrom^{6) Seite 20}
Forward Current^{6) page 20}

$I_F = f(V_F); T_A = 25\text{ °C}$

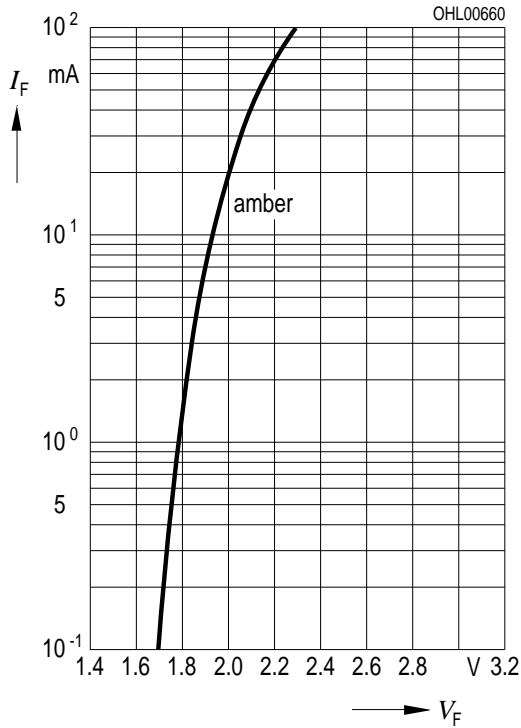

Relative Lichtstärke^{6) 7) Seite 20}

Relative Luminous Intensity^{6) 7) page 20}

$I_V/I_{V(20\text{ mA})} = f(I_F); T_A = 25\text{ °C}$

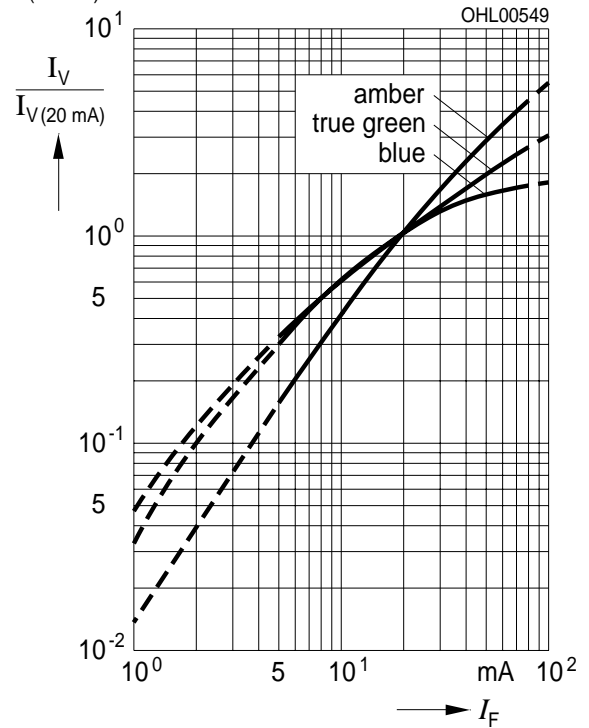

Durchlassstrom^{6) 7) Seite 20}
Forward Current^{6) 7) page 20}

$I_F = f(V_F); T_A = 25\text{ °C}$

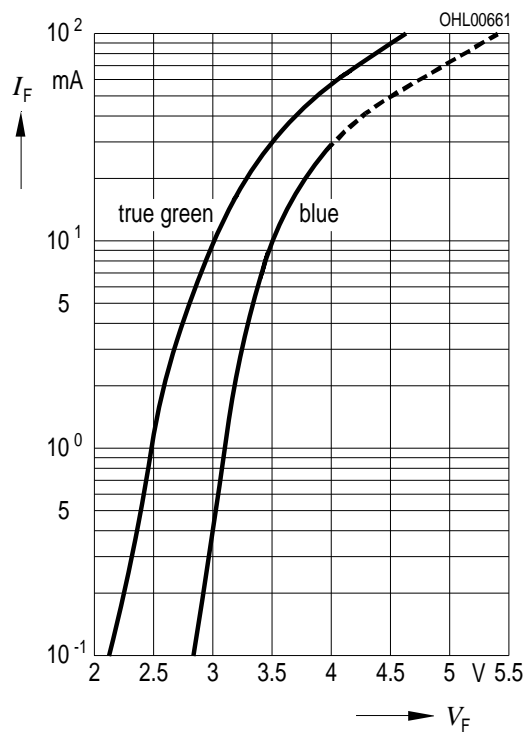

Relative Lichtstärke^{6) Seite 20}

Relative Luminous Intensity^{6) page 20}

$I_V/I_{V(25\text{ °C})} = f(T_j); I_F = 20\text{ mA}$

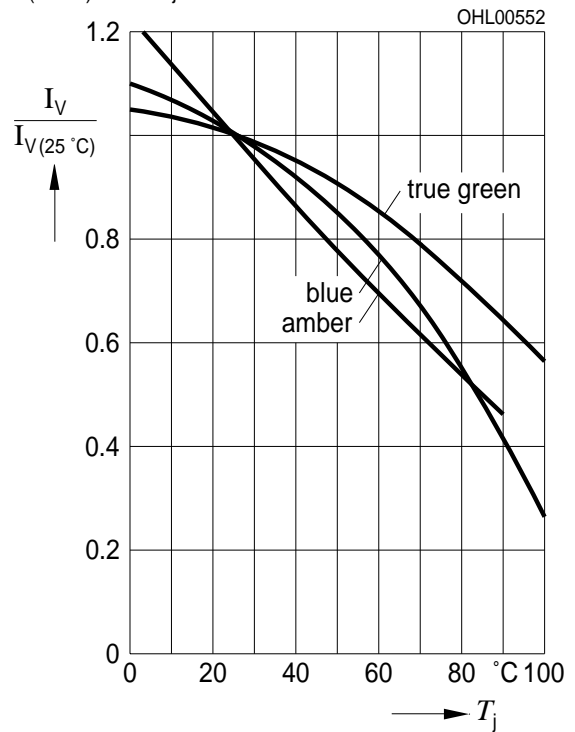

Dominante Wellenlänge⁶⁾ Seite 20

Dominant Wavelength⁶⁾ page 20

true green; $\lambda_{\text{dom}} = f(I_F); T_A = 25\text{ °C}$



Maximal zulässiger Durchlassstrom
Max. Permissible Forward Current

$I_F = f(T)$; 1 chip on

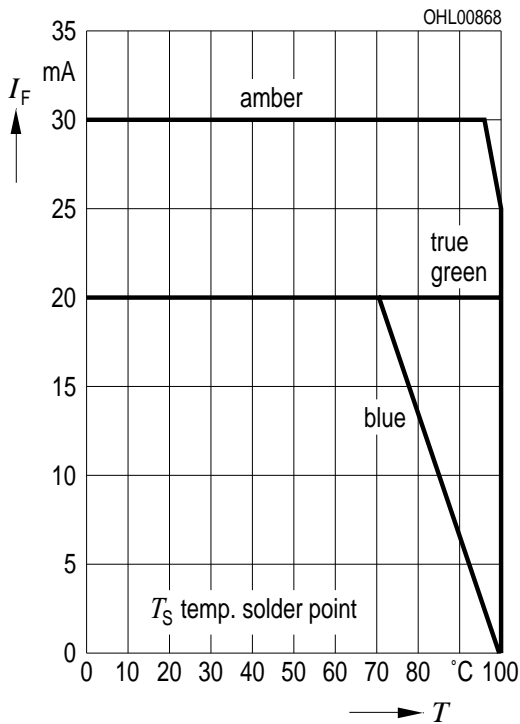

Maximal zulässiger Durchlassstrom
Max. Permissible Forward Current

$I_F = f(T)$; 3 chips on

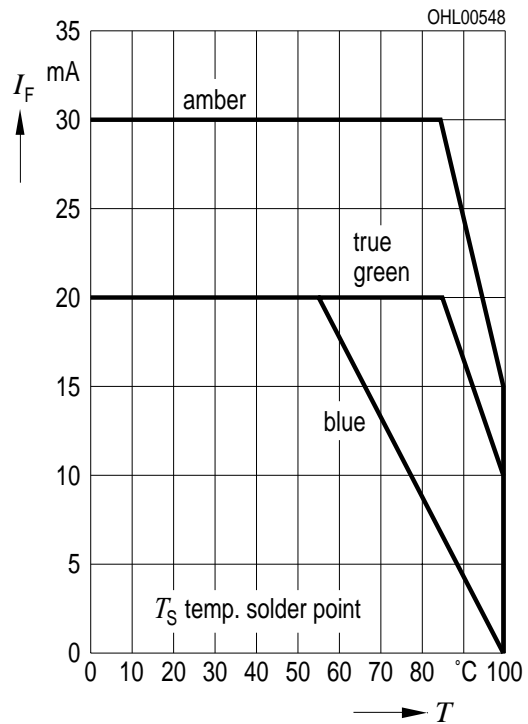

Maximal zulässiger Durchlassstrom
Max. Permissible Forward Current

$I_F = f(T)$; 1 chip on

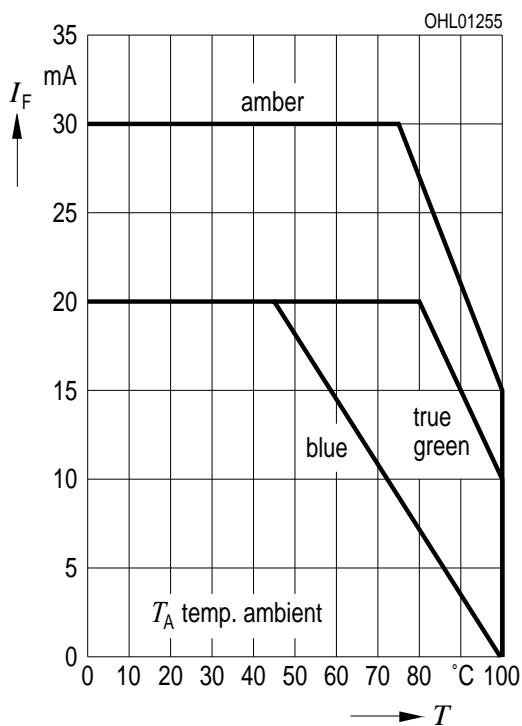

Maximal zulässiger Durchlassstrom
Max. Permissible Forward Current

$I_F = f(T)$; 3 chips on

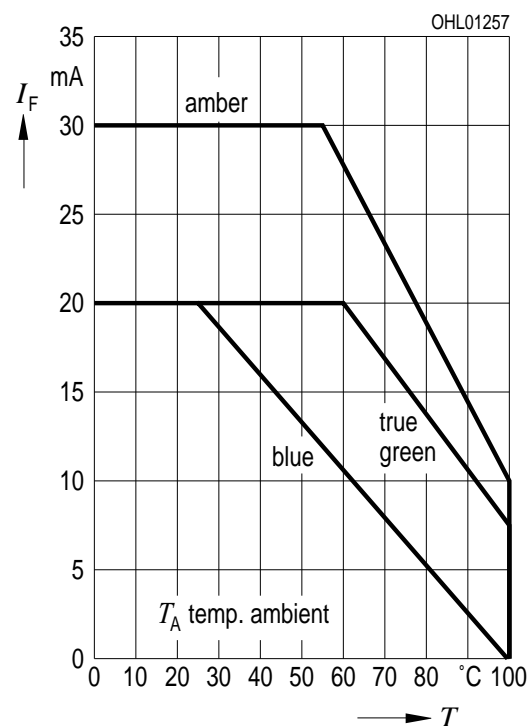

Zulässige Impulsbelastbarkeit $I_F = f(t_p)$
Permissible Pulse Handling Capability
 Duty cycle $D =$ parameter, $T_A = 25\text{ °C}$
amber (1 Chip on)

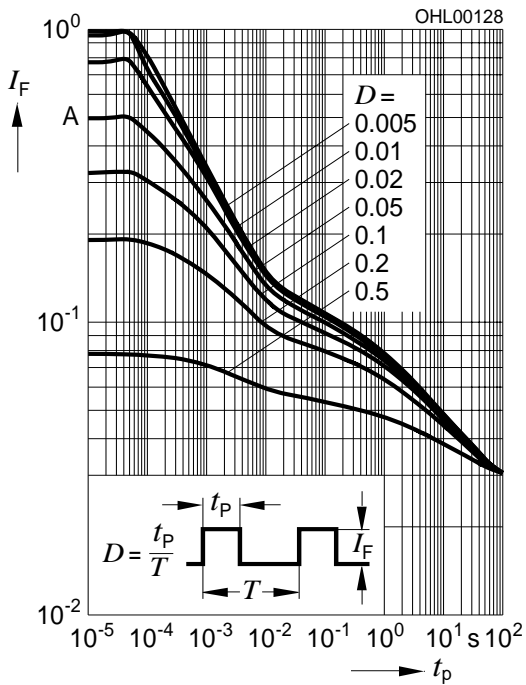

Zulässige Impulsbelastbarkeit $I_F = f(t_p)$
Permissible Pulse Handling Capability
 Duty cycle $D =$ parameter, $T_A = 85\text{ °C}$
amber (1Chip on)

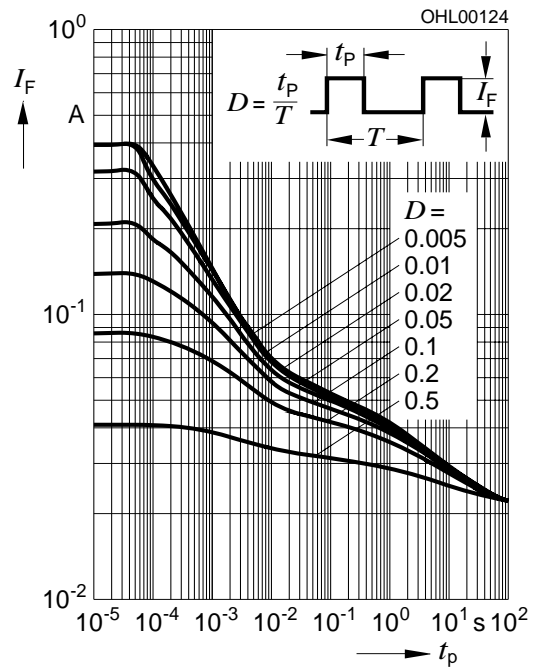

Zulässige Impulsbelastbarkeit $I_F = f(t_p)$
Permissible Pulse Handling Capability
 Duty cycle $D =$ parameter, $T_A = 25\text{ °C}$
amber (3 Chips on)

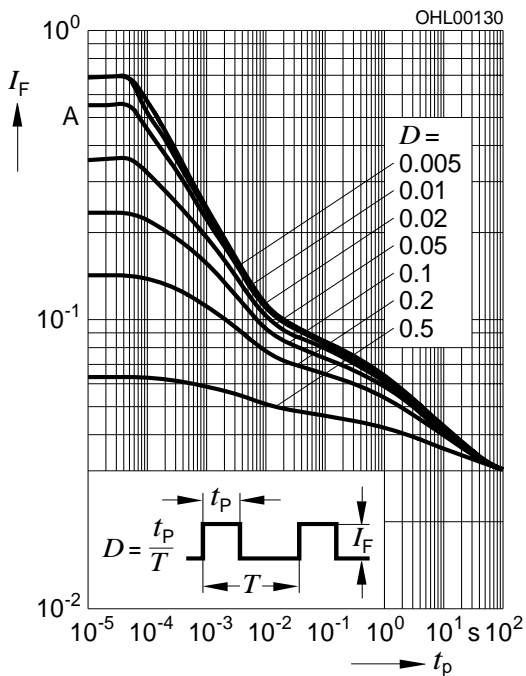

Zulässige Impulsbelastbarkeit $I_F = f(t_p)$
Permissible Pulse Handling Capability
 Duty cycle $D =$ parameter, $T_A = 85\text{ °C}$
amber (3 Chips on)

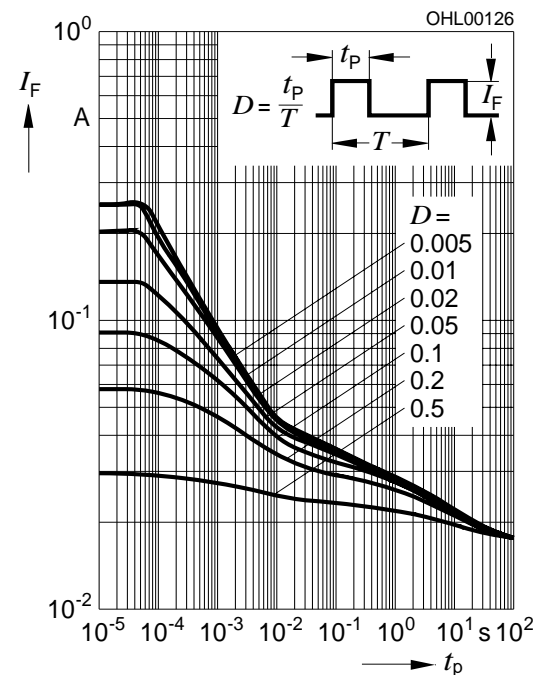

Zulässige Impulsbelastbarkeit $I_F = f(t_p)$
Permissible Pulse Handling Capability
 Duty cycle $D =$ parameter, $T_A = 25\text{ °C}$
 true green (1 Chip on)

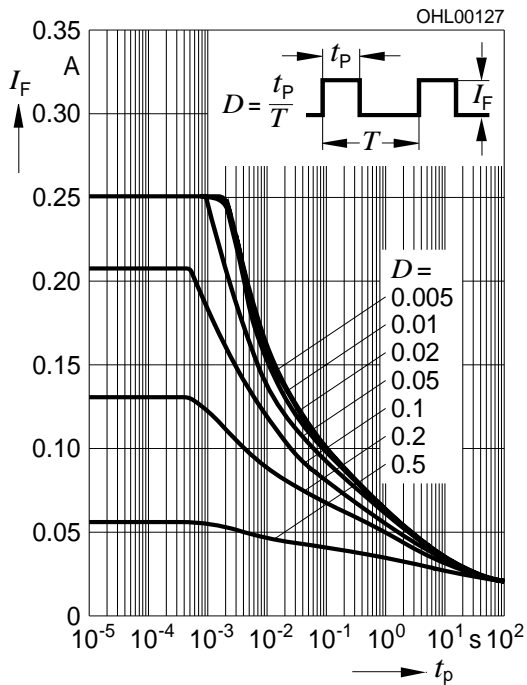

Zulässige Impulsbelastbarkeit $I_F = f(t_p)$
Permissible Pulse Handling Capability
 Duty cycle $D =$ parameter, $T_A = 85\text{ °C}$
 true green (1 Chip on)

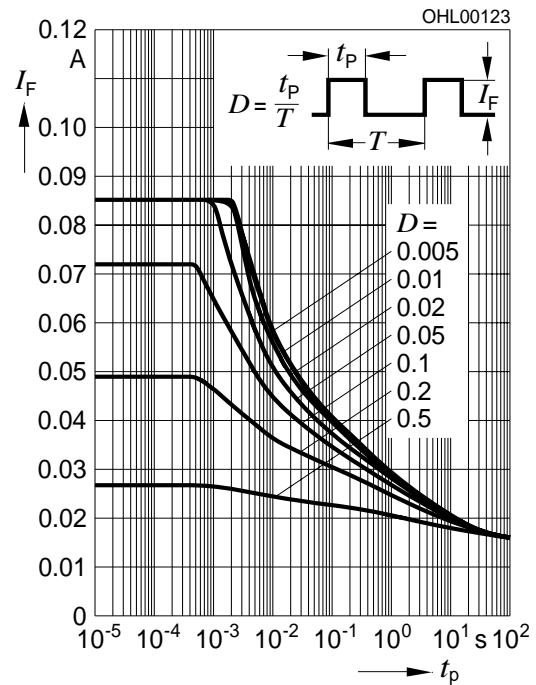

Zulässige Impulsbelastbarkeit $I_F = f(t_p)$
Permissible Pulse Handling Capability
 Duty cycle $D =$ parameter, $T_A = 25\text{ °C}$
 true green (3 Chips on)

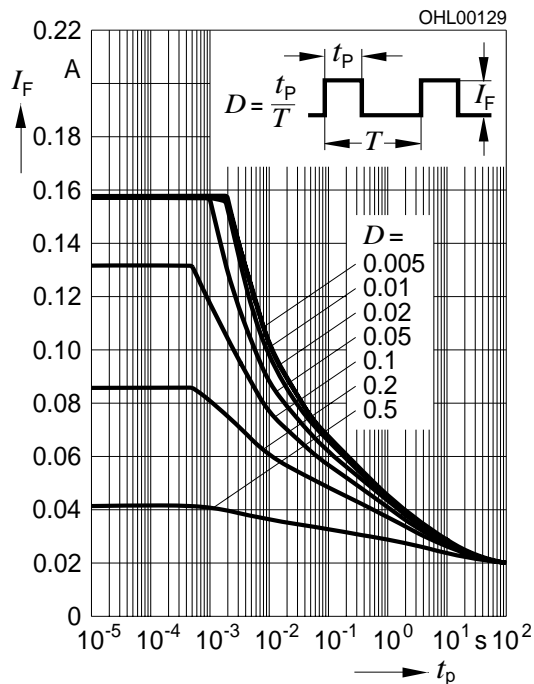

Zulässige Impulsbelastbarkeit $I_F = f(t_p)$
Permissible Pulse Handling Capability
 Duty cycle $D =$ parameter, $T_A = 85\text{ °C}$
 true green (3 Chips on)

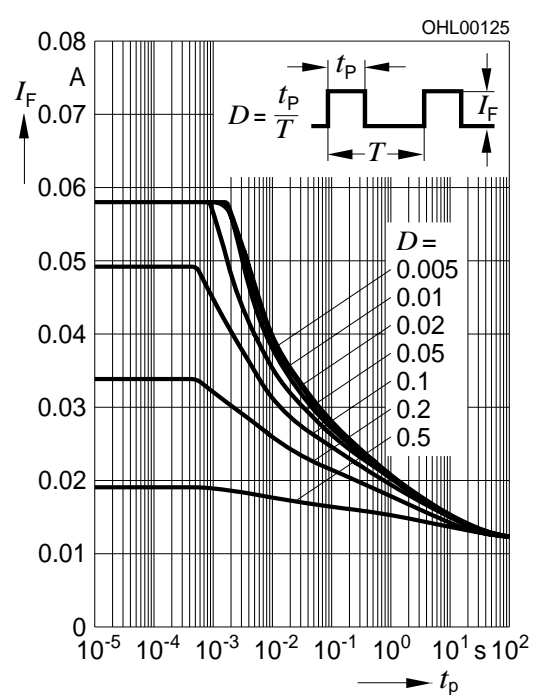

Zulässige Impulsbelastbarkeit $I_F = f(t_p)$
Permissible Pulse Handling Capability
 Duty cycle $D =$ parameter, $T_A = 25\text{ °C}$
blue (1 Chip on)

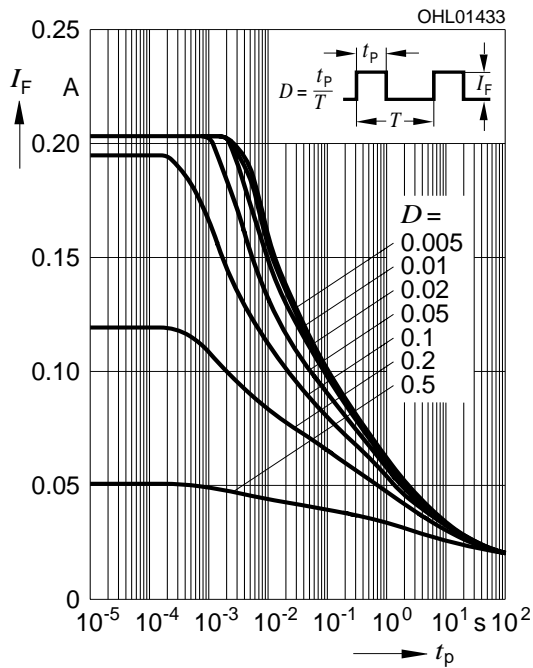

Zulässige Impulsbelastbarkeit $I_F = f(t_p)$
Permissible Pulse Handling Capability
 Duty cycle $D =$ parameter, $T_A = 85\text{ °C}$
blue (1 Chip on)

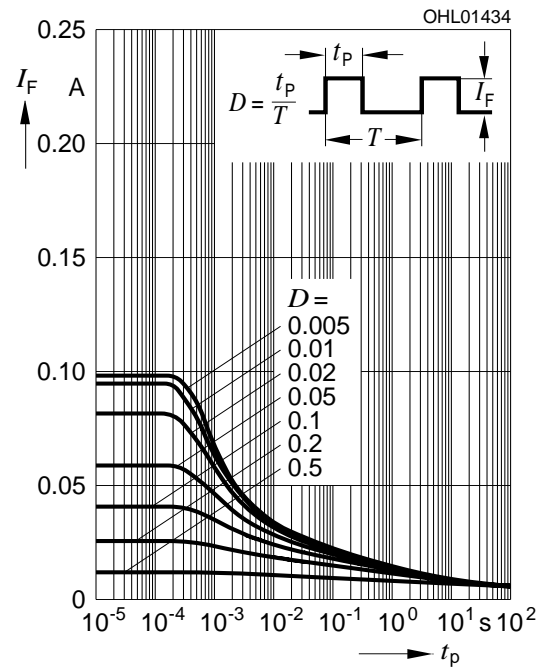

Zulässige Impulsbelastbarkeit $I_F = f(t_p)$
Permissible Pulse Handling Capability
 Duty cycle $D =$ parameter, $T_A = 25\text{ °C}$
blue (3 Chips on)

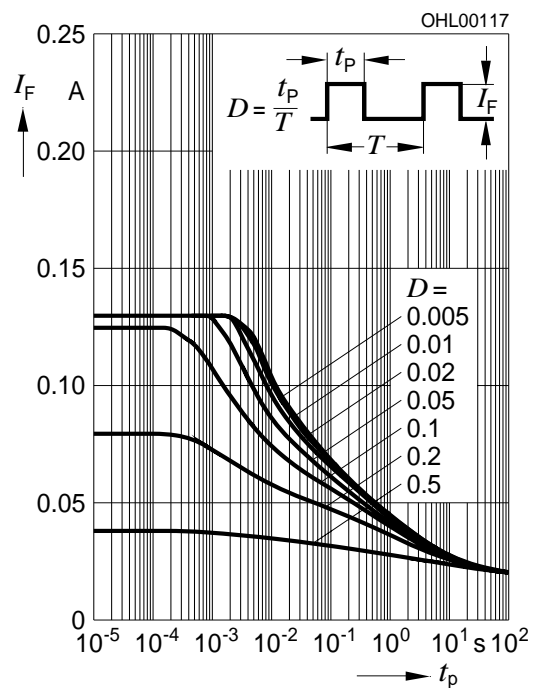

Zulässige Impulsbelastbarkeit $I_F = f(t_p)$
Permissible Pulse Handling Capability
 Duty cycle $D =$ parameter, $T_A = 85\text{ °C}$
blue (3 Chips on)

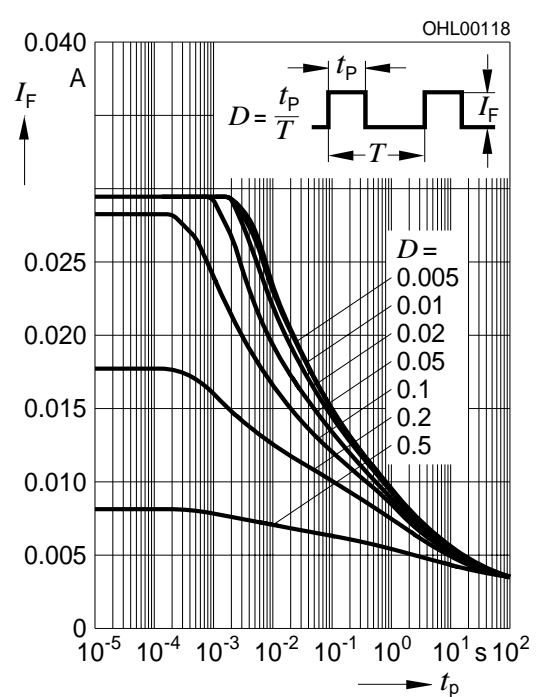

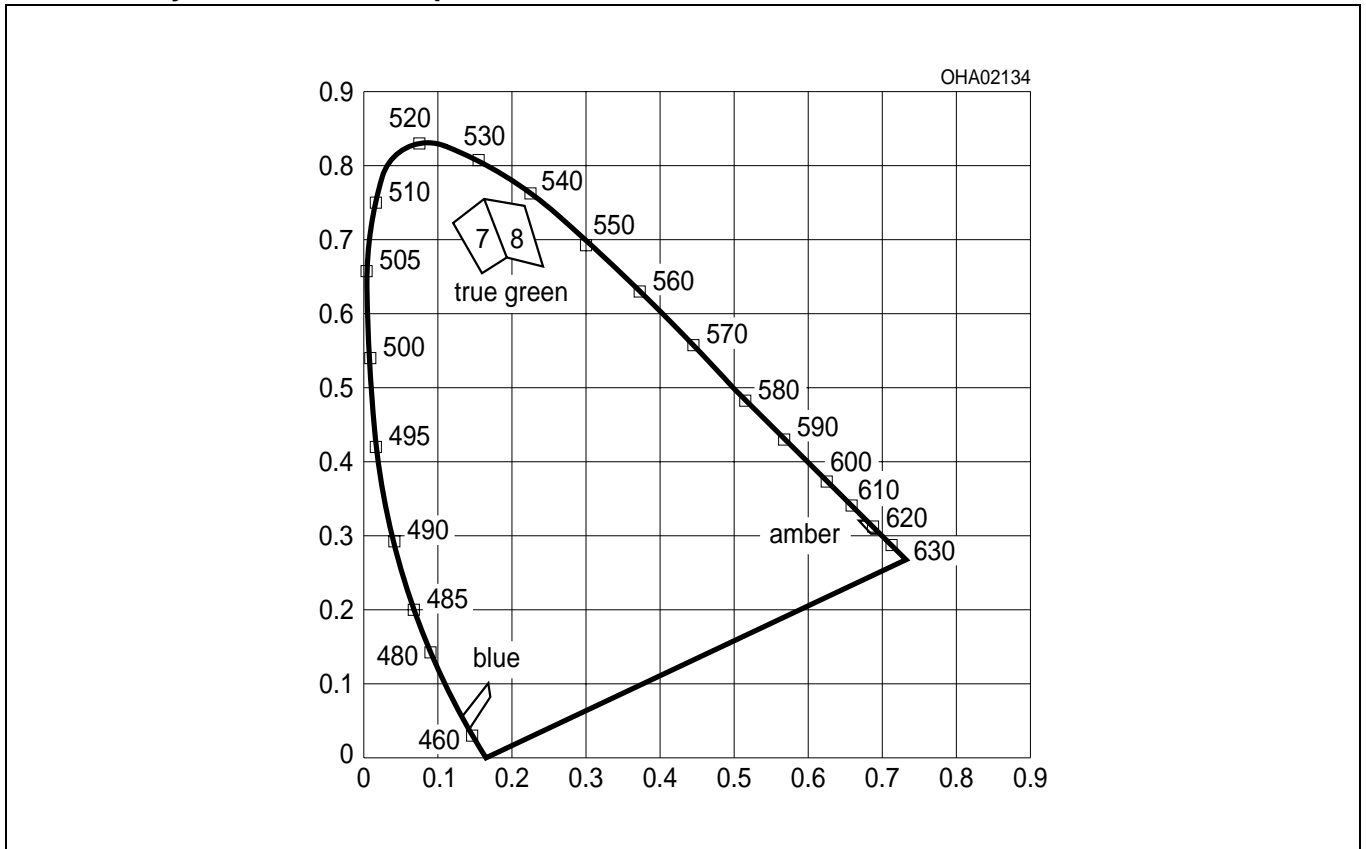

Die Farbkoordinaten des Mischlichtes können innerhalb des gekennzeichneten Bereichs des Farbdreiecks erwartet werden.

The color coordinates of the mixed light can be expected within the area of the color triangle.

Maßzeichnung⁸⁾ Seite 20
 Package Outlines⁸⁾ page 20

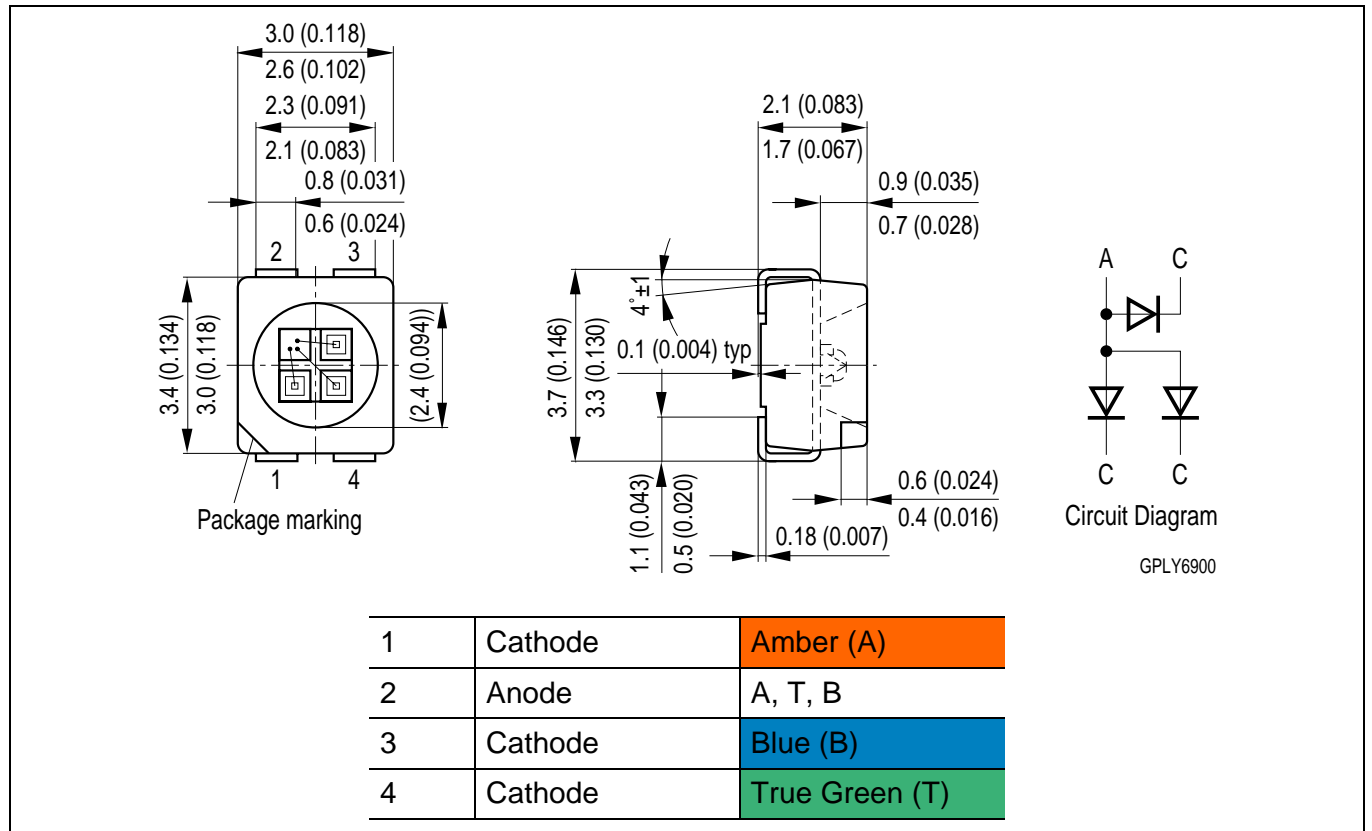

Gewicht / Approx. weight:

35 mg

Gurtung / Polarität und Lage⁸⁾ Seite 20

Verpackungseinheit 2000/Rolle, ø180 mm
 oder 8000/Rolle, ø330 mm

Method of Taping / Polarity and Orientation⁸⁾ page 20

Packing unit 2000/reel, ø180 mm
 or 8000/reel, ø330 mm

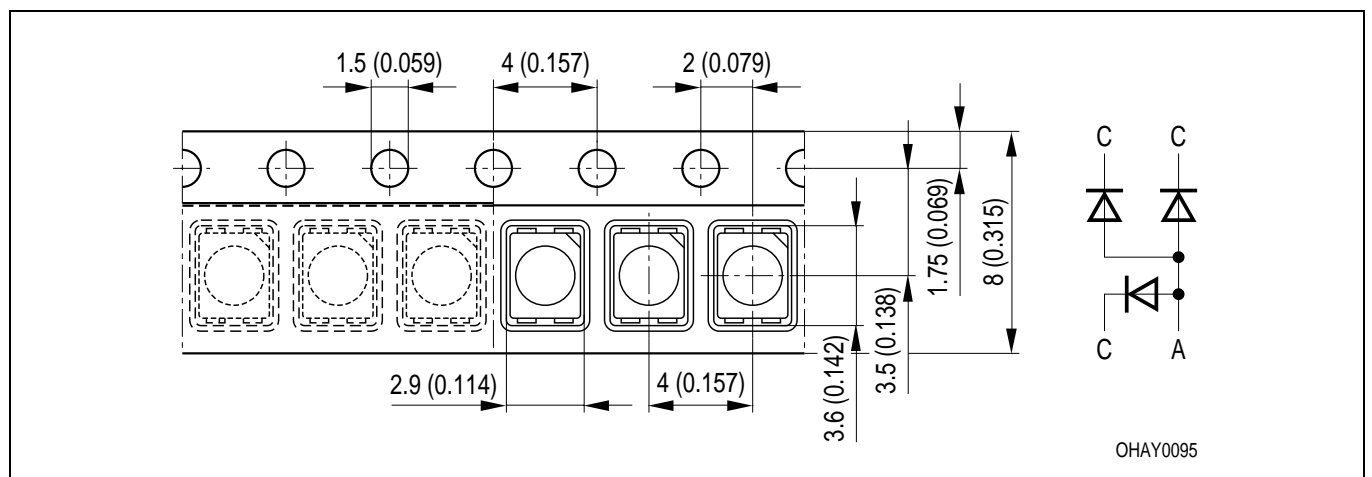

Empfohlenes Lötpad Design⁸⁾ Seite 20
Recommended Solder Pad⁸⁾ page 20

IR Reflow Löten
IR Reflow Soldering

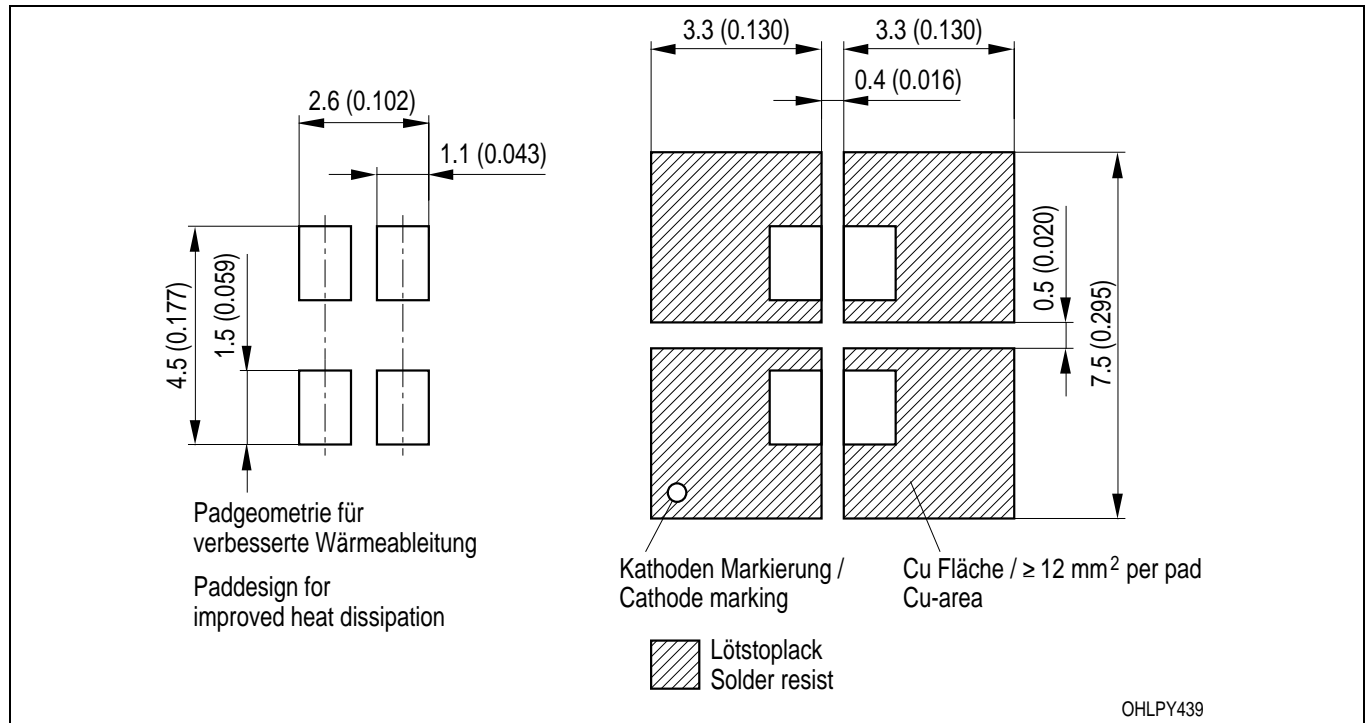

Empfohlenes Lötpad Design⁸⁾ Seite 20
Recommended Solder Pad⁸⁾ page 20

Wellenlöten (TTW)
TTW Soldering

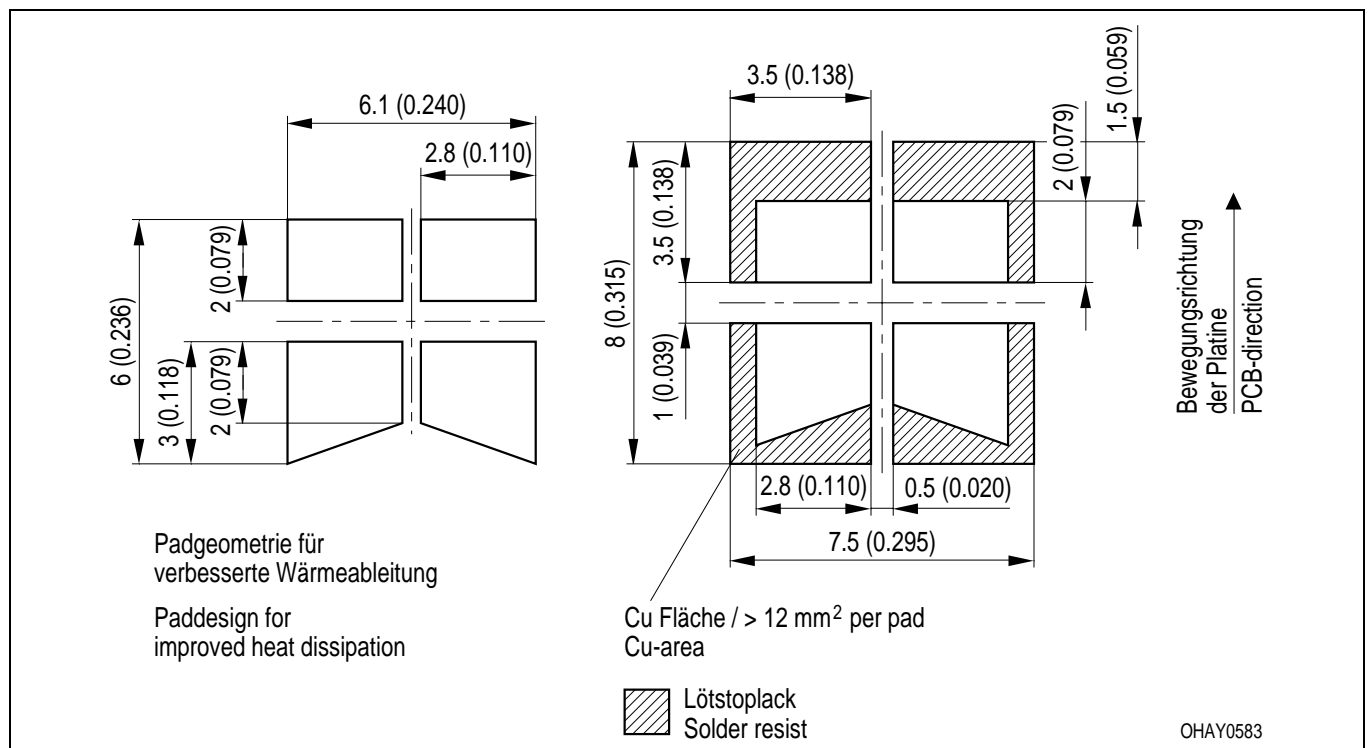

Lötbedingungen
Soldering Conditions

Vorbehandlung nach JEDEC Level 2
Preconditioning acc. to JEDEC Level 2

IR-Reflow Lötprofil
IR Reflow Soldering Profile

(nach IPC 9501)
(acc. to IPC 9501)

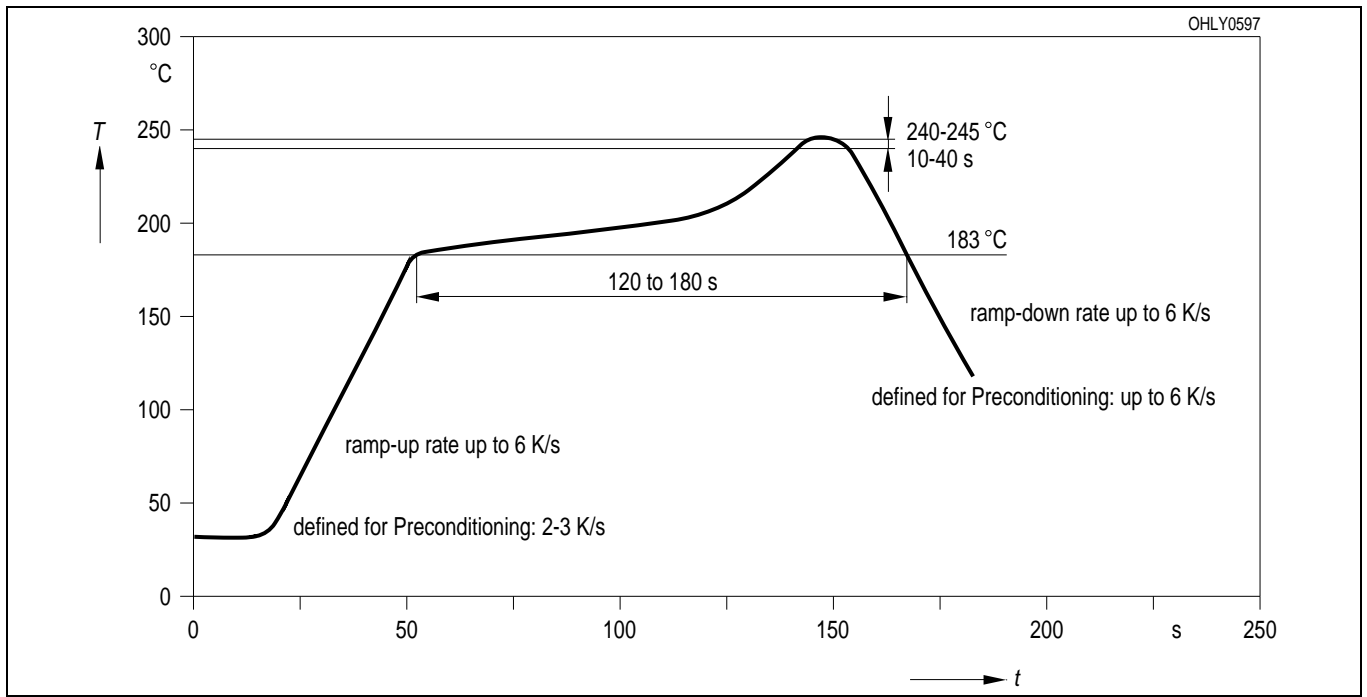

Wellenlöten (TTW)
TTW Soldering

(nach CECC 00802)
(acc. to CECC 00802)

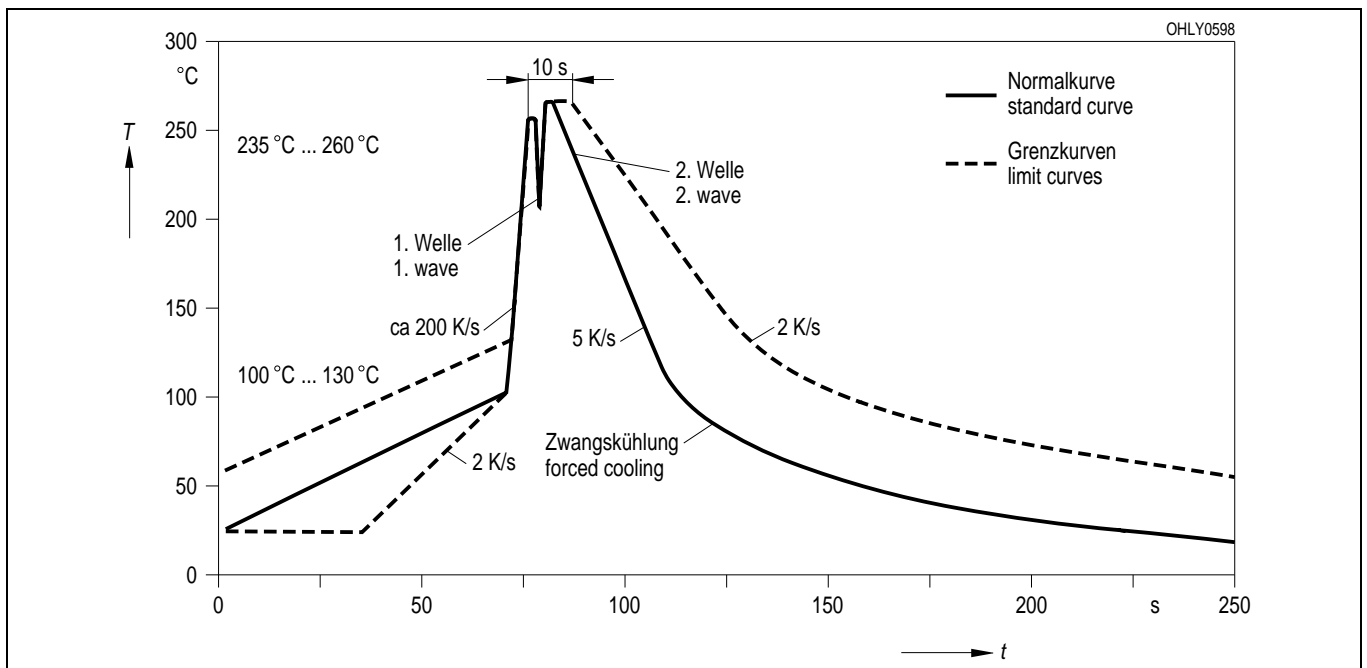

Barcode-Produkt-Etikett (BPL)
Barcode-Product-Label (BPL)

OSRAM Opto Semiconductors

Bin1: Bin Information Color 1
 Bin2:
 Bin3:

ML Temp ST
 2 245 C R
 2 260 C T

(6P) BATCH NO: Batch Number
Bar Code

(1T) LOT NO: Lot Number (9D) D/C: Date Code
Bar Code

(X) PROD NO: Product Code (Q) QTY: Product Quantity per Reel (G) GROUP: X - X - X
Bar Code

Additional TEXT
 R077 DEMY
 PACKVAR: Packing Type

Forward Voltage Rank
 Wavelength Rank
 Brightness Rank

OHA02043

Gurtverpackung
Tape and Reel

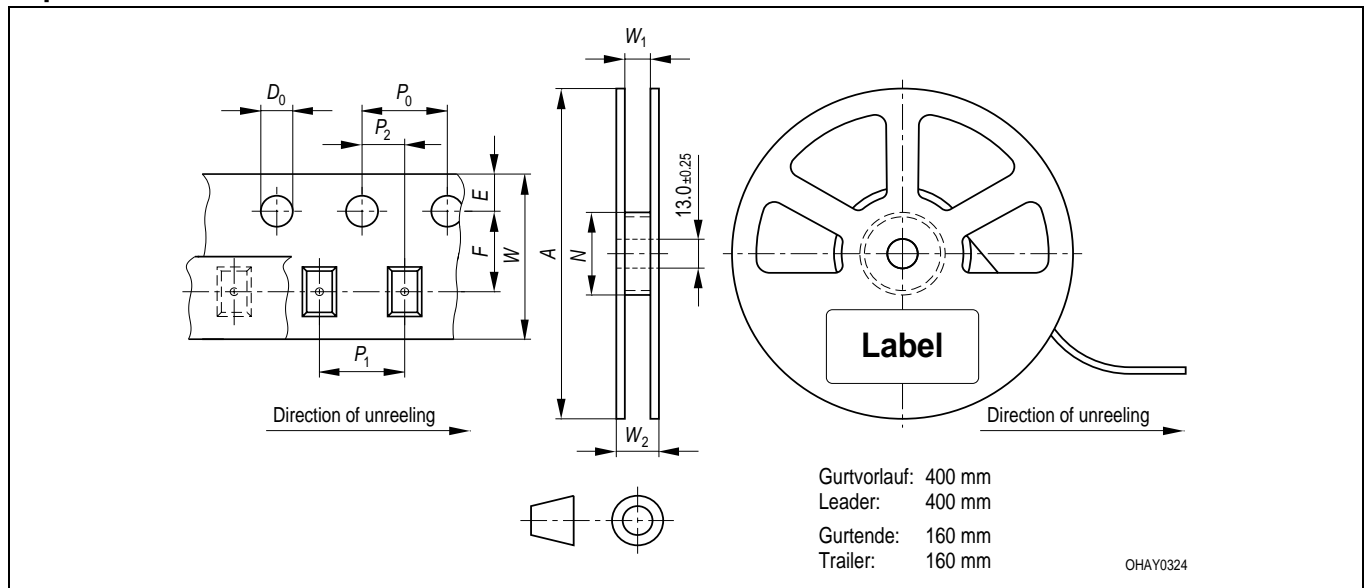

Tape dimensions in mm (inch)

W	P ₀	P ₁	P ₂	D ₀	E	F
8 ^{+0.3} _{-0.1}	4 ± 0.1 (0.157 ± 0.004)	4 ± 0.1 (0.157 ± 0.004)	2 ± 0.05 (0.079 ± 0.002)	1.5 ± 0.1 (0.059 ± 0.004)	1.75 ± 0.1 (0.069 ± 0.004)	3.5 ± 0.05 (0.138 ± 0.002)

Reel dimensions in mm (inch)

A	W	N _{min}	W ₁	W _{2 max}
180 (7)	8 (0.315)	60 (2.362)	8.4 + 2 (0.331 + 0.079)	14.4 (0.567)
330 (13)	8 (0.315)	60 (2.362)	8.4 + 2 (0.331 + 0.079)	14.4 (0.567)

Trockenverpackung und Materialien
Dry Packing Process and Materials

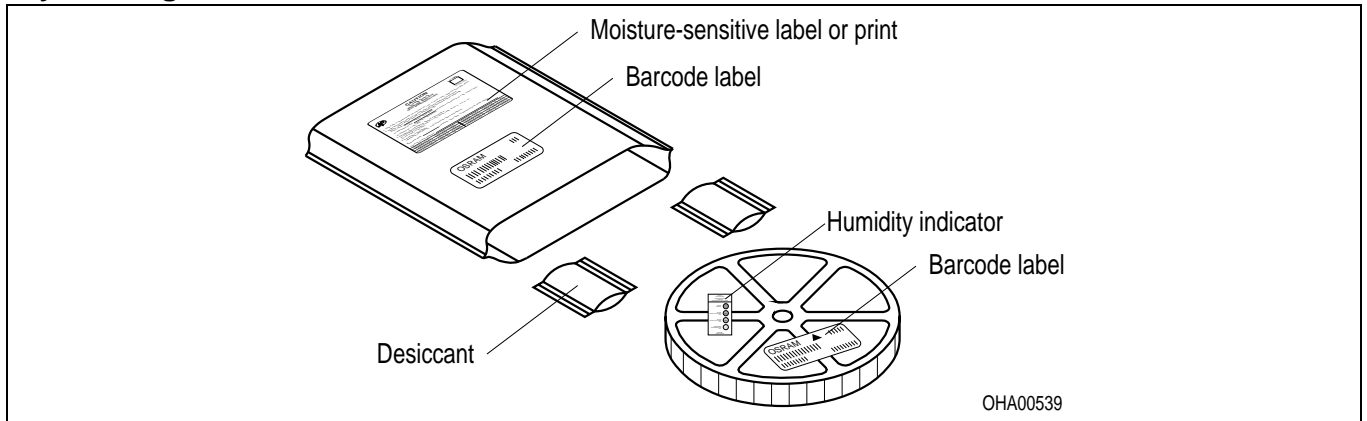

Anm.: Feuchteempfindliche Produkte sind verpackt in einem Trockenbeutel zusammen mit einem Trockenmittel und einer Feuchteindikatorkarte
 Bezüglich Trockenverpackung finden Sie weitere Hinweise im Internet und in unserem Short Form Catalog im Kapitel "Gurtung und Verpackung" unter dem Punkt "Trockenverpackung". Hier sind Normenbezüge, unter anderem ein Auszug der JEDEC-Norm, enthalten.

Note: Moisture-sensitive product is packed in a dry bag containing desiccant and a humidity card.
 Regarding dry pack you will find further information in the internet and in the Short Form Catalog in chapter "Tape and Reel" under the topic "Dry Pack". Here you will also find the normative references like JEDEC.

Kartonverpackung und Materialien
Transportation Packing and Materials

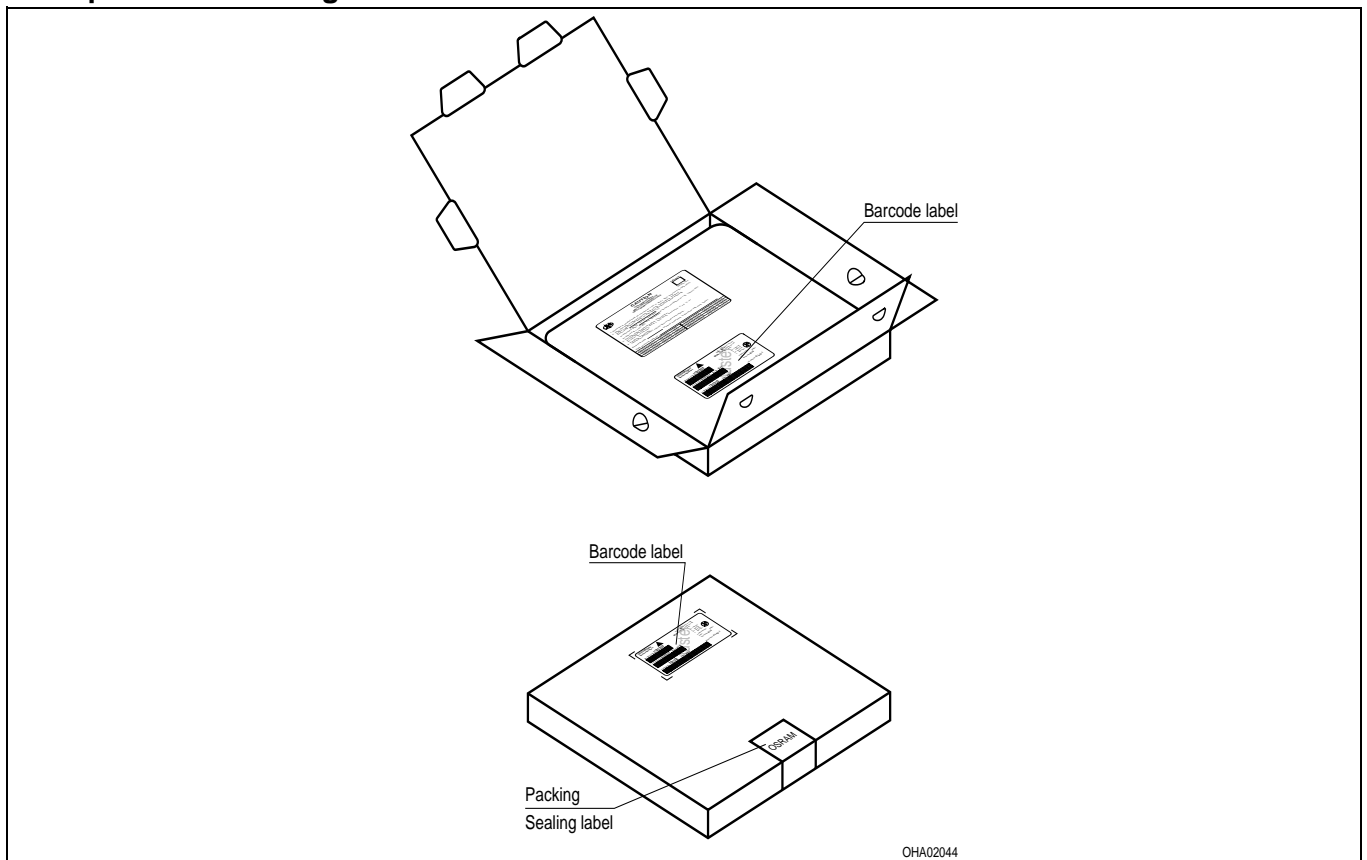

Revision History: 2005-04-05

Previous Version: 2004-08-26

Page	Subjects (major changes since last revision)	Date of change
4	value (forward voltage)	
4	dominant wavelength (blue)	
17	annotations	2002-07-23
3, 4	value (reverse voltage)	2002-09-18
2, 5	new ordering codes	2002-11-08
9	blue: new dominant wavelength diagrams	2002-12-17
3, 4	blue: value (reverse voltage from 12 V to 5 V)	2003-02-11
8	diagram dominant wavelength	2003-06-30
1	ESD norm	2003-08-27
3	ambient temperature	2003-08-27
all	new template	2004-03-09
all	Discontinuation of non-RoHS compliant product versions	2005-04-05

Attention please!

The information describes the type of component and shall not be considered as assured characteristics. Terms of delivery and rights to change design reserved. Due to technical requirements components may contain dangerous substances. For information on the types in question please contact our Sales Organization. If printed or downloaded, please find the latest version in the Internet.

Packing

Please use the recycling operators known to you. We can also help you – get in touch with your nearest sales office. By agreement we will take packing material back, if it is sorted. You must bear the costs of transport. For packing material that is returned to us unsorted or which we are not obliged to accept, we shall have to invoice you for any costs incurred.

Components used in life-support devices or systems must be expressly authorized for such purpose! Critical components^{9) page 20} may only be used in life-support devices or systems^{10) page 20} with the express written approval of OSRAM OS.

Fußnoten:

- 1) Helligkeitswerte werden mit einer Stromeinprägedauer von 25 ms und einer Genauigkeit von $\pm 11\%$ ermittelt.
- 2) Die LED kann kurzzeitig in Sperrichtung betrieben werden.
- 3) R_{thJA} ergibt sich bei Montage auf PC-Board FR 4 (Padgröße $\geq 16 \text{ mm}^2$ je Pad)
- 4) Wellenlängen werden mit einer Stromeinprägedauer von 25 ms und einer Genauigkeit von $\pm 1 \text{ nm}$ ermittelt.
- 5) Spannungswerte werden mit einer Stromeinprägedauer von 1 ms und einer Genauigkeit von $\pm 0,1 \text{ V}$ ermittelt.
- 6) Wegen der besonderen Prozessbedingungen bei der Herstellung von LED können typische oder abgeleitete technische Parameter nur aufgrund statistischer Werte wiedergegeben werden. Diese stimmen nicht notwendigerweise mit den Werten jedes einzelnen Produktes überein, dessen Werte sich von typischen und abgeleiteten Werten oder typischen Kennlinien unterscheiden können. Falls erforderlich, z.B. aufgrund technischer Verbesserungen, werden diese typischen Werte ohne weitere Ankündigung geändert.
- 7) Im gestrichelten Bereich der Kennlinien muss mit erhöhten Helligkeitsunterschieden zwischen Leuchtdioden innerhalb einer Verpackungseinheit gerechnet werden.
Dimmverhältnis im Gleichstrom-Betrieb max. 5:1 für amber
- 8) Maße werden wie folgt angegeben: mm (inch)
- 9) Ein kritisches Bauteil ist ein Bauteil, das in lebenserhaltenden Apparaten oder Systemen eingesetzt wird und dessen Defekt voraussichtlich zu einer Fehlfunktion dieses lebenserhaltenden Apparates oder Systems führen wird oder die Sicherheit oder Effektivität dieses Apparates oder Systems beeinträchtigt.
- 10) Lebenserhaltende Apparate oder Systeme sind für
 - (a) die Implantierung in den menschlichen Körper oder
 - (b) für die Lebenserhaltung bestimmt.
 Falls sie versagen, kann davon ausgegangen werden, dass die Gesundheit und das Leben des Patienten in Gefahr ist.

Remarks:

- 1) Brightness groups are tested at a current pulse duration of 25 ms and a tolerance of $\pm 11\%$.
- 2) Driving the LED in reverse direction is suitable for short term application.
- 3) R_{thJA} results from mounting on PC board FR 4 (pad size $\geq 16 \text{ mm}^2$ per pad)
- 4) Wavelengths are tested at a current pulse duration of 25 ms and a tolerance of $\pm 1 \text{ nm}$.
- 5) Forward voltages are tested at a current pulse duration of 1 ms and a tolerance of $\pm 0.1 \text{ V}$.
- 6) Due to the special conditions of the manufacturing processes of LED, the typical data or calculated correlations of technical parameters can only reflect statistical figures. These do not necessarily correspond to the actual parameters of each single product, which could differ from the typical data and calculated correlations or the typical characteristic line. If requested, e.g. because of technical improvements, these typ. data will be changed without any further notice.
- 7) In the range where the line of the graph is broken, you must expect higher brightness differences between single LEDs within one packing unit.
Dimming range for direct current mode max. 5:1 for amber
- 8) Dimensions are specified as follows: mm (inch)
- 9) A critical component is a component used in a life-support device or system whose failure can reasonably be expected to cause the failure of that life-support device or system, or to affect its safety or the effectiveness of that device or system.
- 10) Life support devices or systems are intended
 - (a) to be implanted in the human body,
 - or
 - (b) to support and/or maintain and sustain human life.
 If they fail, it is reasonable to assume that the health and the life of the user may be endangered.