

LC ARGUS® LED

Low Current 3 mm (T1) LED, Non Diffused

LS K389, LY K389, LG K389



**Abgekündigt nach PD_078_02 - werden durch
LG_LS_LY K380 ersetzt werden**
**Obsolete acc. to PD_078_02 - will be replaced by
LG_LS_LY K380**

Besondere Merkmale

- **Gehäusotyp:** eingefärbtes, klares 3 mm (T1) Gehäuse mit spezieller Linse
- **Besonderheit des Bauteils:** hohe Lichtstärke bei kleinen Strömen; mit Einsatz eines äußeren Reflektors zur Hinterleuchtung von Leuchtfeldern und LCD-Anzeigen; Lötspieße mit Aufsetzebene
- **Wellenlänge:** 628 nm (super-rot), 587 nm (gelb), 570 nm (grün)
- **Abstrahlwinkel:** angepasst an Einsatz mit äußerem Reflektor, siehe Diagramm
- **Technologie:** GaAsP
- **optischer Wirkungsgrad:** 2 lm/W
- **Gruppierungsparameter:** Lichtstrom
- **Lötmethode:** Wellenlöten (TTW)
- **Verpackung:** Schüttgut, gegurtet lieferbar

Anwendungen

- Hinterleuchtung (LCD, Schalter, Tasten, Displays, Werbebeleuchtung, Allgemeinbeleuchtung)
- Innenbeleuchtung im Automobilbereich (z.B. Instrumentenbeleuchtung, u.ä.)
- Einkopplung in Lichtleiter

Features

- **package:** colored, clear 3 mm (T1) package with specially shaped lens
- **feature of the device:** high luminous intensity at low currents; for backlighting and LCDs with use of a reflector; solder leads with stand-off
- **wavelength:** 628 nm (super-red), 587 nm (yellow), 570 nm (green)
- **viewing angle:** matched to use with external reflector, see diagram
- **technology:** GaAsP
- **optical efficiency:** 2 lm/W
- **grouping parameter:** luminous flux
- **soldering methods:** TTW soldering
- **packing:** bulk, available taped on reel

Applications

- backlighting (LCD, switches, keys, displays, illuminated advertising, general lighting)
- interior automotive lighting (e.g. dashboard backlighting, etc.)
- coupling into light guides

Typ Type	Emissionsfarbe Color of Emission	Gehäusefarbe Color of Package	Lichtstrom Luminous Flux $I_F = 2 \text{ mA}$ $\Phi_V \text{ (mlm)}$	Bestellnummer Ordering Code
■ LS K389-F	super-red	red clear	1.2 ... 7.2	Q62703-Q1771
■ LY K389-F	yellow	yellow clear	1.2 ... 7.2	Q62703-Q1772
■ LG K389-F	green	green clear	1.2 ... 7.2	Q62703-Q1773

Helligkeitswerte werden mit einer Stromeinprägedauer von 25 ms und einer Genauigkeit von $\pm 11 \%$ ermittelt.
Luminous intensity is tested at a current pulse duration of 25 ms and a tolerance of $\pm 11 \%$

- Abgekündigt nach PD_078_02 - werden durch LG_LS_LY K380 ersetzt werden
Obsolete acc. to PD_078_02 - will be replaced by LG_LS_LY K380
Letzte Bestellung / Last Order: 30.09.2003
Letzte Lieferung / Last Delivery: 31.03.2004

*Anm.: Die Standardlieferform von Serientypen beinhaltet eine untere bzw. eine obere Familiengruppe oder mindestens zwei Einzelgruppen.
In einer Verpackungseinheit / Gurt ist immer nur eine Helligkeitsgruppe enthalten.
Die technologiebedingte Helligkeits-Streuung der heutigen LED-Herstellprozesse über einen längeren Fertigungszeitraum (Halbleitermaterial - Chipherstellung - Montageprozess) erlaubt keine Zusage einer einzelnen Helligkeitsgruppe. Daher müssen mindestens zwei Helligkeitsgruppen vorgesehen werden!*

*Note: The standard shipping format for serial types includes a lower or upper family group or at least two individual groups.
No packing unit / tape ever contains more than one luminous intensity group.
Luminosity variations caused by the technology used in current LED manufacturing processes over a protracted manufacturing period (semiconductor material - chip fabrication - assembly process) mean that it is not possible to assign LEDs to a single luminous intensity group. For this reason at least two luminous intensity groups must be provided!*

Bezeichnung Parameter	Symbol Symbol	Wert Value	Einheit Unit
Betriebstemperatur Operating temperature range	T_{op}	- 55 ... + 100	°C
Lagertemperatur Storage temperature range	T_{stg}	- 55 ... + 100	°C
Sperrschichttemperatur Junction temperature	T_j	+ 100	°C
Durchlassstrom Forward current	I_F	7.5	mA
Stoßstrom Surge current $t \leq 10 \mu s, D = 0.005$	I_{FM}	150	mA
Sperrspannung ¹⁾ Reverse voltage	V_R	12	V
Leistungsaufnahme Power consumption $T_A \leq 25 \text{ °C}$	P_{tot}	20	mW
Wärmewiderstand ²⁾ Thermal resistance Sperrschicht/Umgebung Junction/ambient Sperrschicht/Löt看pad Junction/solder point Montage auf PC-Board FR 4 (Padgröße $\geq 16 \text{ mm}^2$) mounted on PC board FR 4 (pad size $\geq 16 \text{ mm}^2$) Minimale Beinchenlänge Minimum lead length	$R_{th JA}$ $R_{th JS}$	400 180	K/W K/W

¹⁾ für kurzzeitigen Betrieb geeignet / suitable for short term application

²⁾ R_{th} erhöht sich um 13 K/W pro mm Beinchenlänge.
Each additional 1 mm of lead length increases R_{th} by 13 K/W.

Bezeichnung Parameter	Symbol Symbol	Werte Values			Einheit Unit
		LS	LY	LG	
Wellenlänge des emittierten Lichtes Wavelength at peak emission $I_F = 2 \text{ mA}$	(typ.) λ_{peak}	635	586	572	nm
Dominantwellenlänge ¹⁾ Dominant wavelength $I_F = 2 \text{ mA}$	(typ.) λ_{dom}	628	587	570	nm
Spektrale Bandbreite bei 50 % $I_{\text{rel max}}$ Spectral bandwidth at 50 % $I_{\text{rel max}}$ $I_F = 2 \text{ mA}$	(typ.) $\Delta\lambda$	45	45	25	nm
Durchlassspannung ²⁾ Forward voltage $I_F = 2 \text{ mA}$	(typ.) V_F (max.) V_F	1.8 2.5	2.0 2.6	1.9 2.5	V V
Sperrstrom Reverse current $V_R = 12 \text{ V}$	(typ.) I_R (max.) I_R	0.01 10	0.01 10	0.01 10	μA μA
Temperaturkoeffizient von λ_{peak} Temperature coefficient of λ_{peak} $I_F = 2 \text{ mA}; -10^\circ\text{C} \leq T \leq 100^\circ\text{C}$	(typ.) $TC_{\lambda_{\text{peak}}}$	0.11	0.10	0.11	nm/K
Temperaturkoeffizient von λ_{dom} Temperature coefficient of λ_{dom} $I_F = 2 \text{ mA}; -10^\circ\text{C} \leq T \leq 100^\circ\text{C}$	(typ.) $TC_{\lambda_{\text{dom}}}$	0.07	0.07	0.07	nm/K
Temperaturkoeffizient von V_F Temperature coefficient of V_F $I_F = 2 \text{ mA}; -10^\circ\text{C} \leq T \leq 100^\circ\text{C}$	(typ.) TC_V	-2.0	-1.6	-1.9	mV/K
Optischer Wirkungsgrad Optical efficiency $I_F = 2 \text{ mA}$	(typ.) η_{opt}	2	2	2	lm/W

¹⁾ Wellenlängen werden mit einer Stromeinprägedauer von 25 ms und einer Genauigkeit von $\pm 1 \text{ nm}$ ermittelt.
Wavelengths are tested at a current pulse duration of 25 ms and a tolerance of $\pm 1 \text{ nm}$.

²⁾ Spannungswerte werden mit einer Stromeinprägedauer von 1 ms und einer Genauigkeit von $\pm 0,1 \text{ V}$ ermittelt.
Voltages are tested at a current pulse duration of 1 ms and a tolerance of $\pm 0.1 \text{ V}$.

Relative spektrale Emission $I_{rel} = f(\lambda)$, $T_A = 25\text{ °C}$, $I_F = 2\text{ mA}$

Relative Spectral Emission

$V(\lambda)$ = spektrale Augenempfindlichkeit

Standard eye response curve

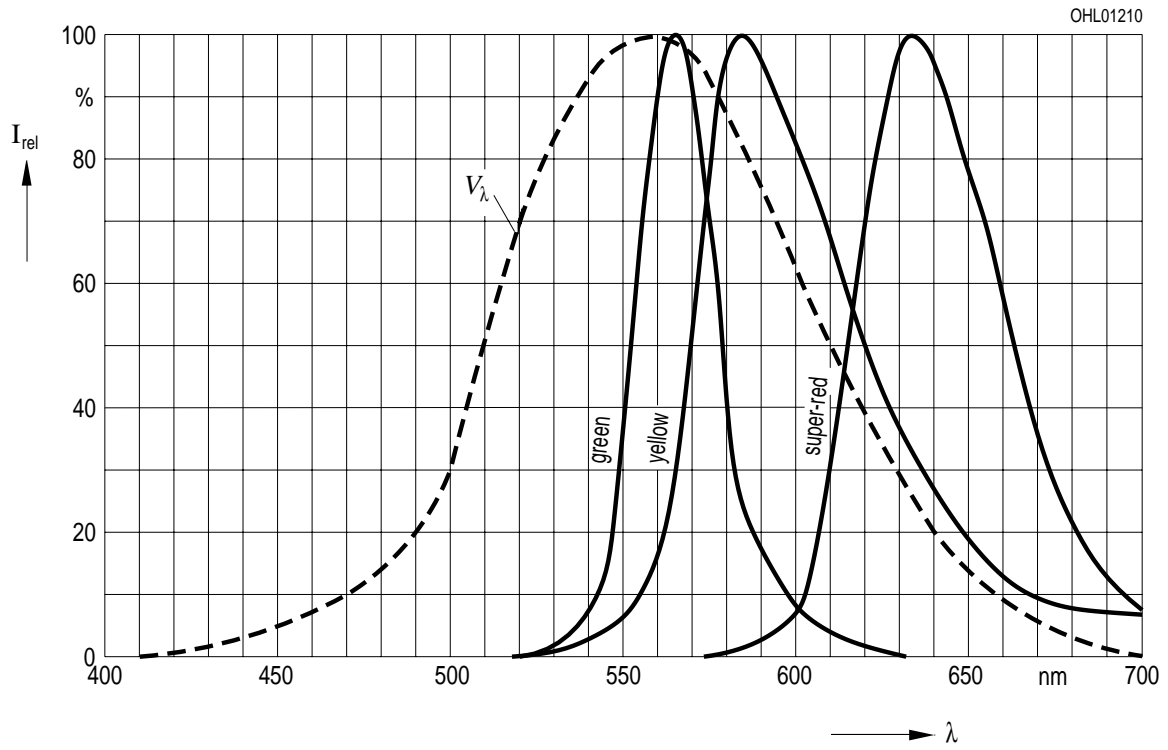

Abstrahlcharakteristik $I_{rel} = f(\varphi)$

Radiation Characteristic

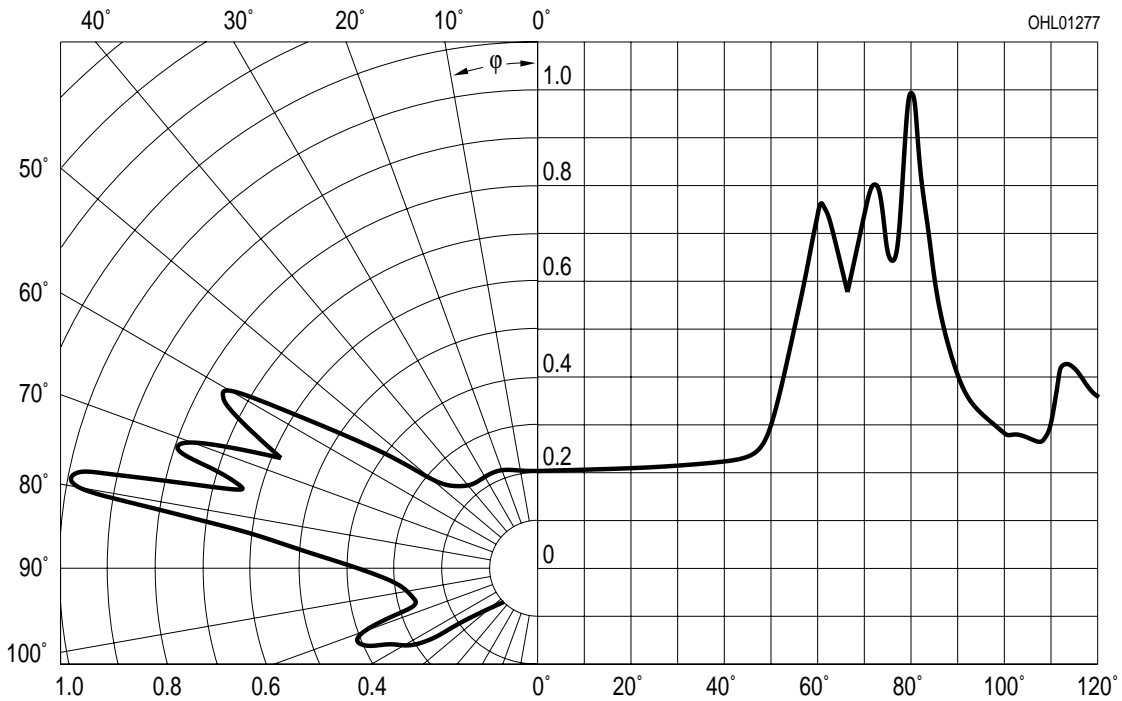

Durchlassstrom $I_F = f(V_F)$
Forward Current

$T_A = 25\text{ °C}$

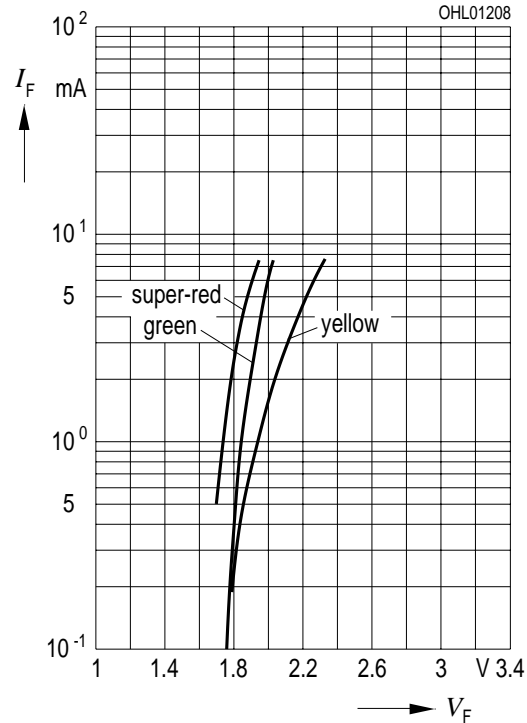

Relativer Lichtstrom $\Phi_V/\Phi_{V(2\text{ mA})} = f(I_F)$
Relative Luminous Flux

$T_A = 25\text{ °C}$

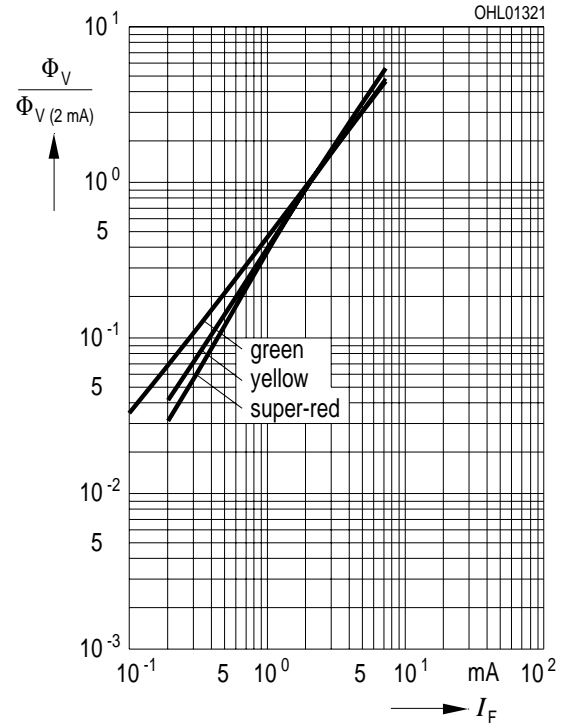

Maximal zulässiger Durchlassstrom $I_F = f(T)$
Max. Permissible Forward Current

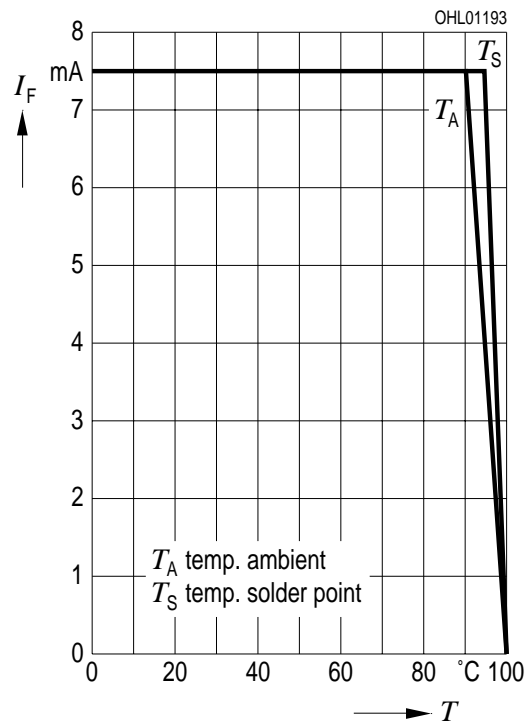

Relativer Lichtstrom $\Phi_V/\Phi_{V(25\text{ °C})} = f(T_A)$
Relative Luminous Flux

$I_F = 2\text{ mA}$

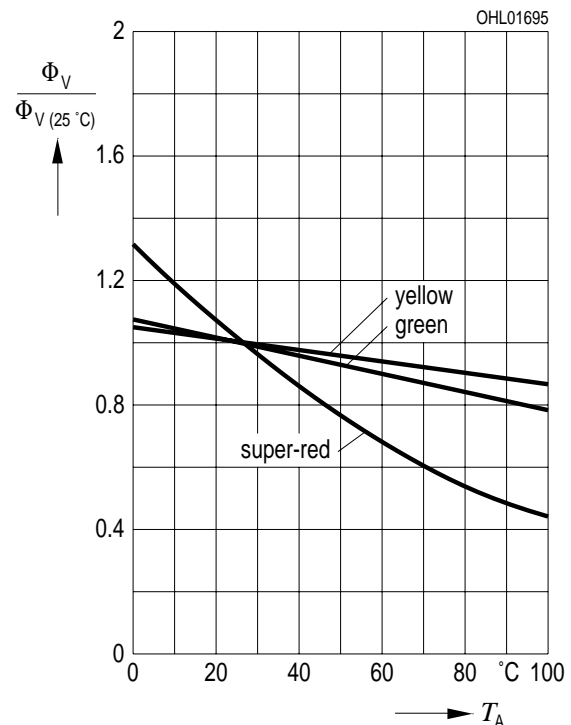

Zulässige Impulsbelastbarkeit $I_F = f(t_p)$
Permissible Pulse Handling Capability

Duty cycle $D =$ parameter, $T_A = 25\text{ °C}$

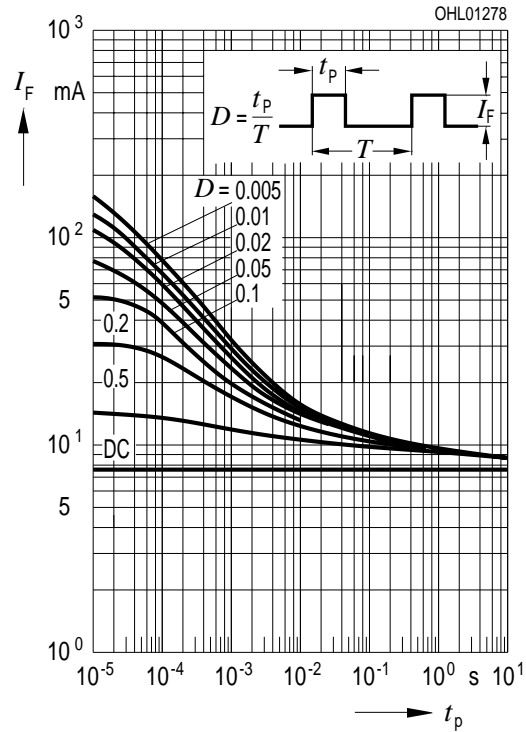

Maßzeichnung
Package Outlines

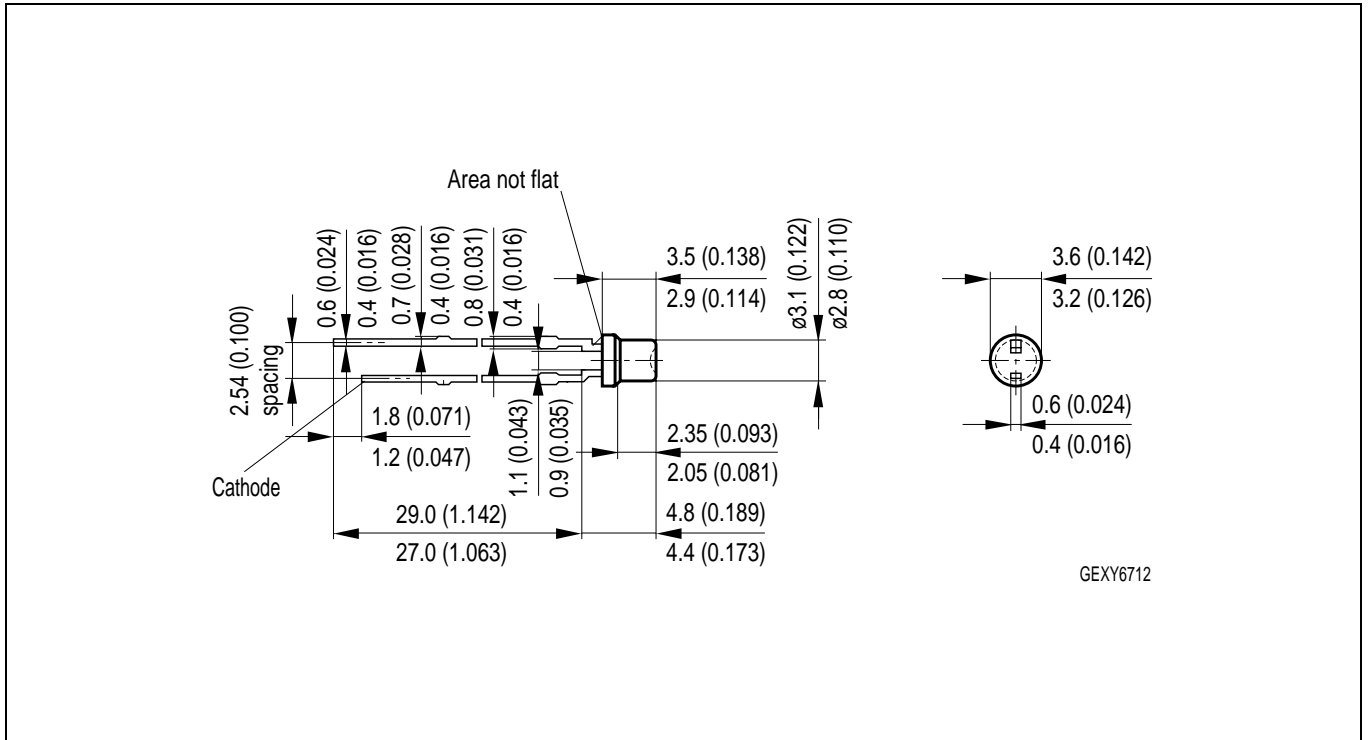

Maße werden wie folgt angegeben: mm (inch) / Dimensions are specified as follows: mm (inch).

Kathodenkennung: kürzerer Lötspieß
Cathode mark: short solder lead
Gewicht / Approx. weight: 160 mg

Lötbedingungen
Soldering Conditions

Wellenlöten (TTW) (nach CECC 00802)
TTW Soldering (acc. to CECC 00802)

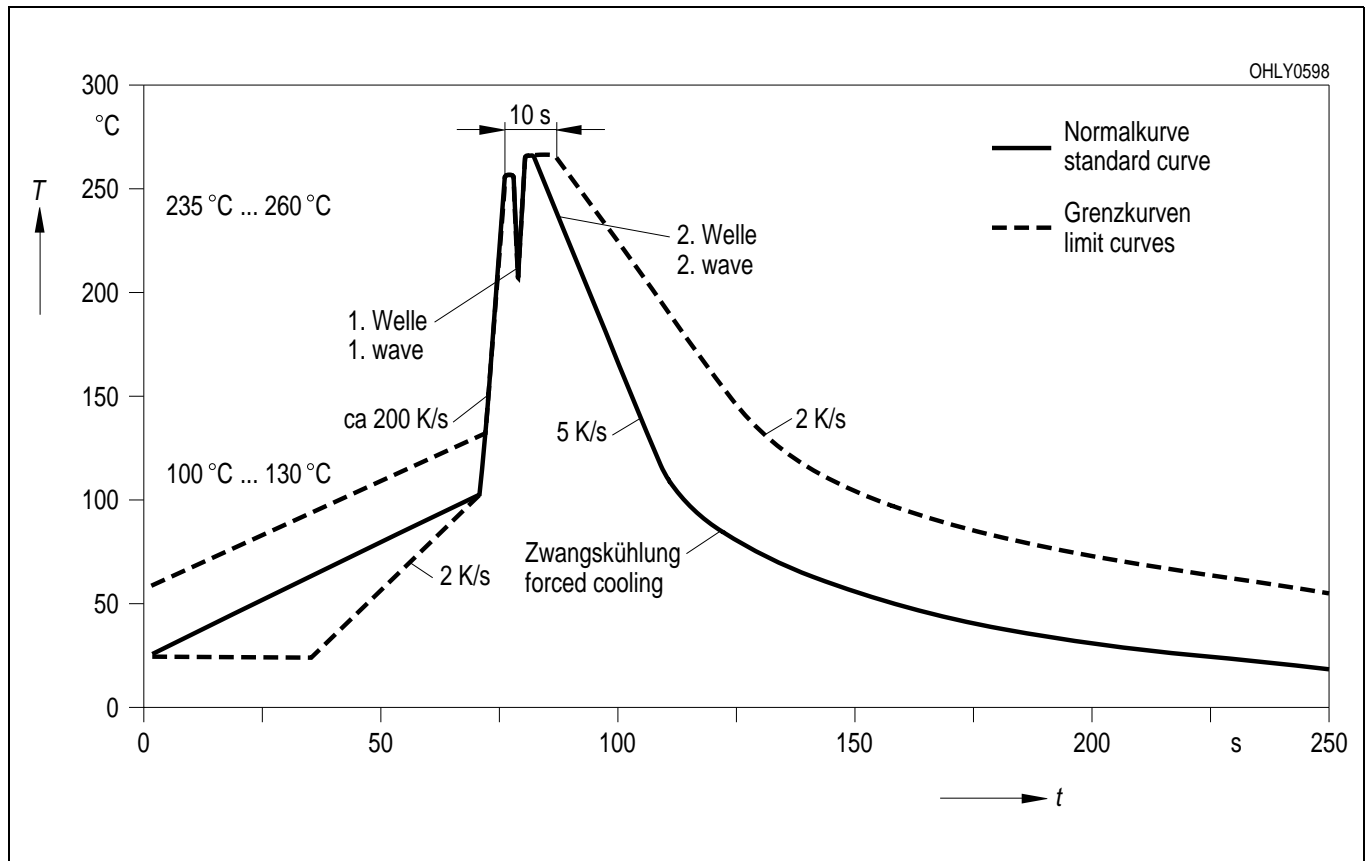

Empfohlenes Lötpaddesign Wellenlöten (TTW)
Recommended Solder Pad TTW Soldering

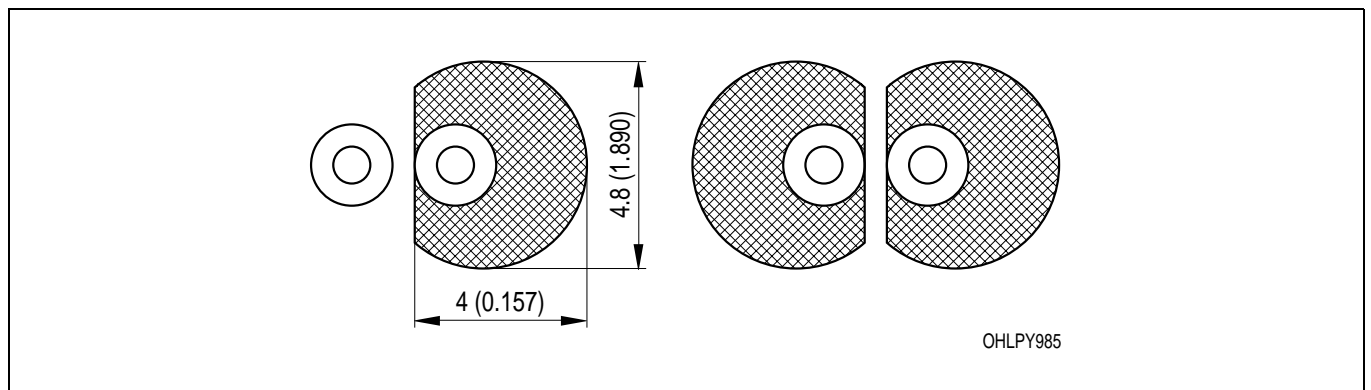

Maße werden wie folgt angegeben: mm (inch) / Dimensions are specified as follows: mm (inch).

Revision History: 2003-08-07		Date of change
Previous Version: 2002-09-18		
Page	Subjects (major changes since last revision)	
3	thermal resistance (footnote)	
4	value (wavelength yellow)	
10	annotations	2002-07-23
3, 4	value (reverse voltage from 5 V to 12 V)	2002-09-18
2	wavelength grouping	2002-09-18
1, 2	Obsolete	2003-08-07

Published by OSRAM Opto Semiconductors GmbH & Co. OHG
Wernerwerkstrasse 2, D-93049 Regensburg

© All Rights Reserved.

Attention please!

The information describes the type of component and shall not be considered as assured characteristics.

All typical data and graphs are basing on representative samples, but don't represent the production range. If requested, e.g. because of technical improvements, these typ. data will be changed without any further notice.

Terms of delivery and rights to change design reserved. Due to technical requirements components may contain dangerous substances. For information on the types in question please contact our Sales Organization.

If printed or downloaded, please find the latest version in the Internet.

Packing

Please use the recycling operators known to you. We can also help you – get in touch with your nearest sales office. By agreement we will take packing material back, if it is sorted. You must bear the costs of transport. For packing material that is returned to us unsorted or which we are not obliged to accept, we shall have to invoice you for any costs incurred.

Components used in life-support devices or systems must be expressly authorized for such purpose! Critical components ¹ may only be used in life-support devices or systems ² with the express written approval of OSRAM OS.

¹ A critical component is a component used in a life-support device or system whose failure can reasonably be expected to cause the failure of that life-support device or system, or to affect its safety or the effectiveness of that device or system.

² Life support devices or systems are intended (a) to be implanted in the human body, or (b) to support and/or maintain and sustain human life. If they fail, it is reasonable to assume that the health of the user may be endangered.