

●Features

- High heat radiation "PSML2" series
- Low package by flat frame structure
- High Luminous Intensity

●Size

4520 (1808)
4.5 × 2.0mm (t=0.6mm)

Color
Type

WB

●Outline

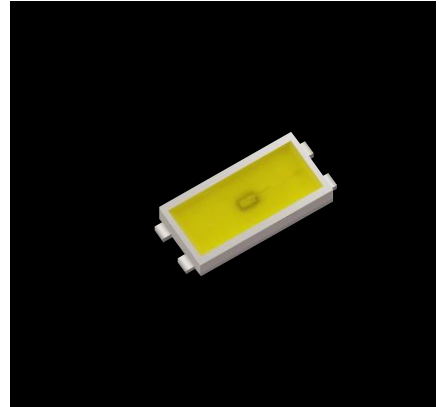

●Dimensions

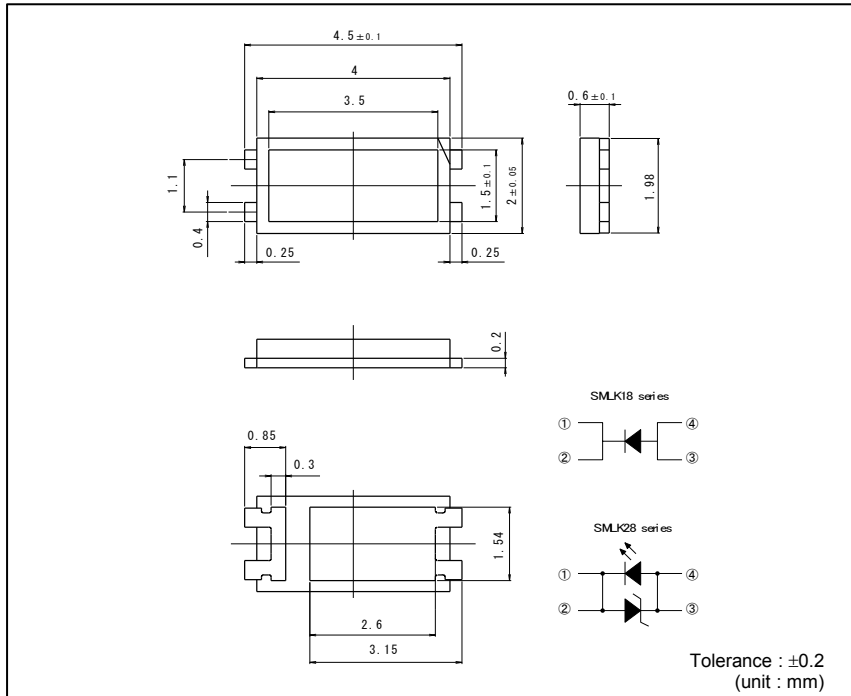

●Recommended Solder Patter

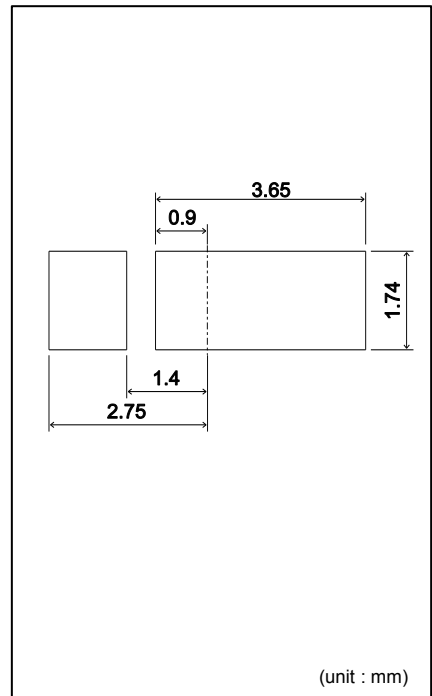

●Specifications

Part No.	Chip Structure	Emitting Color	Absolute Maximum Ratings (Ta=25°C)					Electrical and Optical Characteristics (Ta=25°C)										
			Power Dissipation Pd(mW)	Forward Current If(mA)	Peak Forward Current Ifp(mA)	Reverse Voltage Vr(V)	Operating Temp. Topr(°C)	Storage Temp. Tstg(°C)	Forward Voltage Vf		Reverse Current Ir		Chromaticity		Luminous Intensity Iv		Luminous Intensity Iv	
								Typ. (V)	If (mA)	Max. (μA)	Vr (V)	(x, y)	If (mA)	Min. (mcd)	Typ. (mcd)	If (mA)	Typ. (lm)	If (mA)
<input type="checkbox"/> SMLK18WBJAW	InGaN	White (5000K)	675	150	230*1	5	-40 to +100	-40 to +100	3.9	90	10	5	(0.36, 0.36)	90	4.8	(17)	90	
<input type="checkbox"/> SMLK18WBJBW		White (3000K)											(0.44, 0.40)			(4.5)		(16)
<input type="checkbox"/> SMLK18WBJCW		White											(0.30, 0.28)			(5.9)		(21)
<input type="checkbox"/> SMLK18WBJDW													(0.34, 0.34)			(6.0)		(22)
<input type="checkbox"/> SMLK28WBJCW													(0.30, 0.28)			(5.9)		(21)

*1:Duty1/10, 1kHz () :Reference

●Electrical Characteristics Curves

Fig.1 Forward Current - Forward Voltages

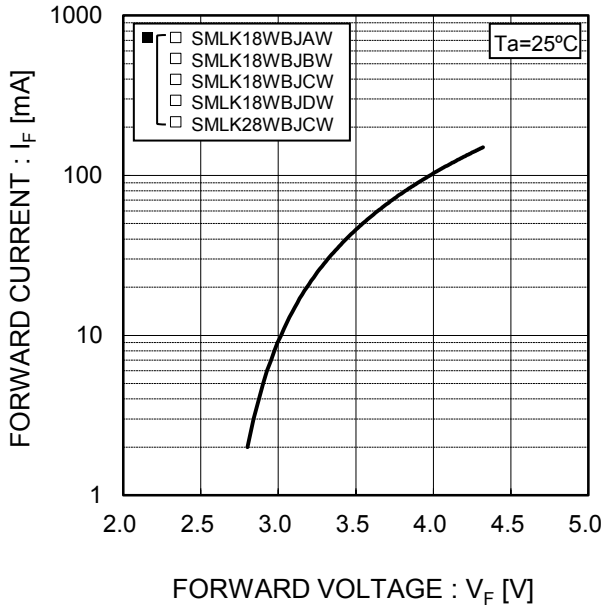

Fig.2 Luminous Intensity - Atmosphere Temperature

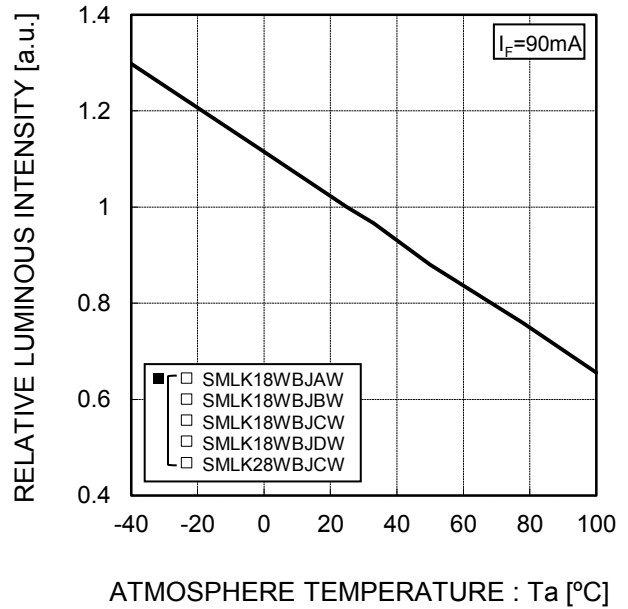

Fig.3 Luminous Intensity - Forward Current

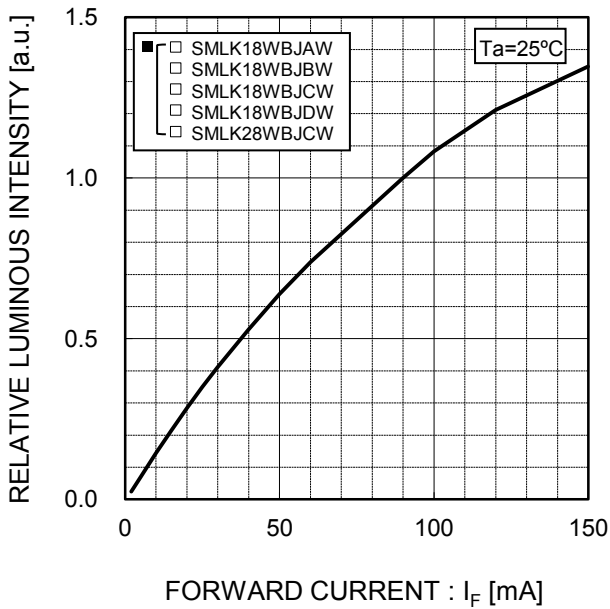
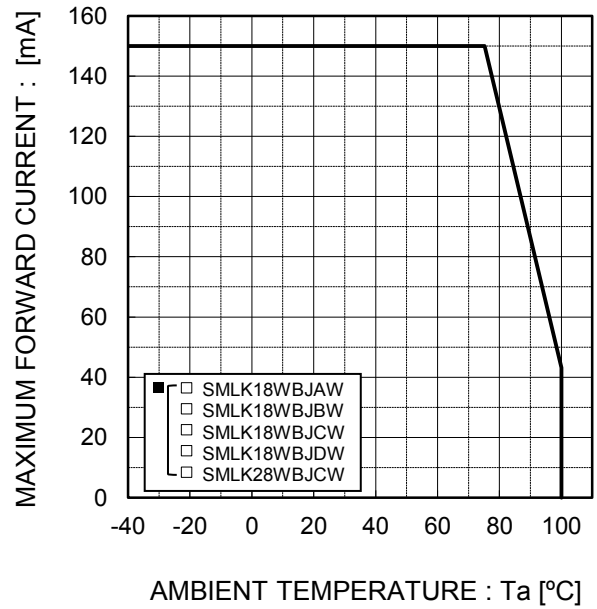
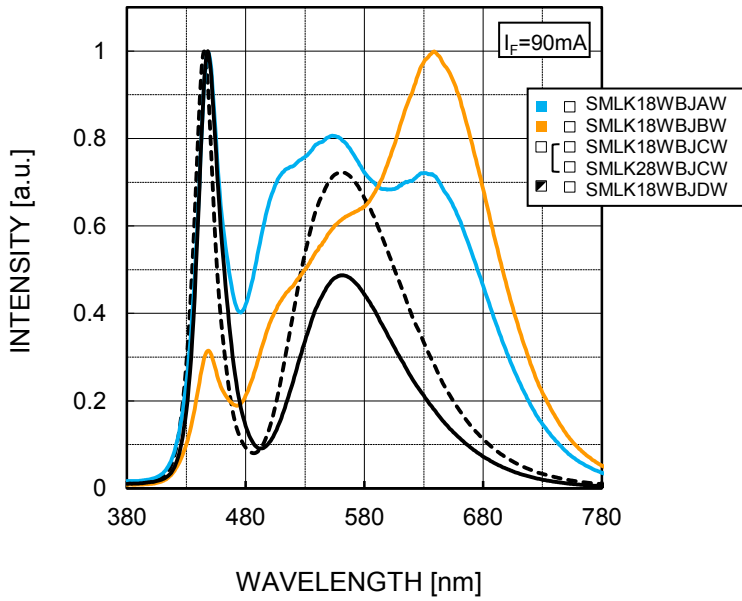

Fig.4 Derating



*50mm × 50mm t=1.6mm Cu foil : 70 μm

● Spectrum Data



* Please take this data as a reference data for the samples are measured randomly.

● Viewing Angle

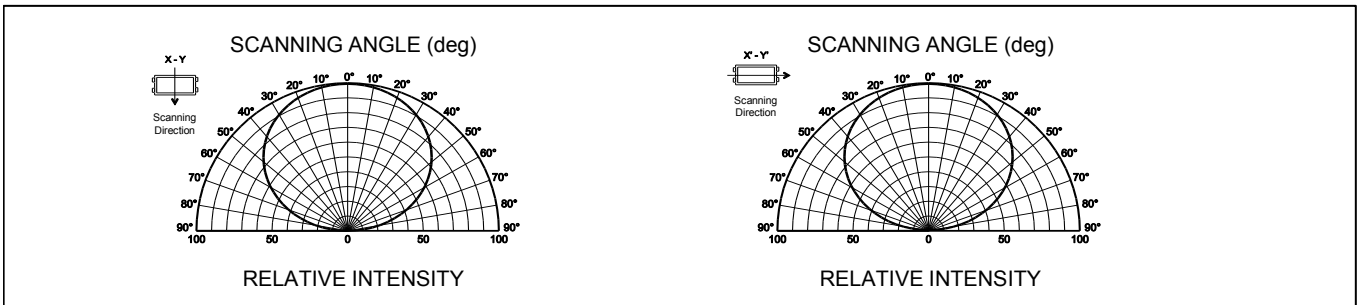

● Rank Reference of Brightness

White(WB)

Rank	C	D	E	F	G	H	J	K	L	M	N	P	Q	R	S	T	U
I_v (mcd)	2.2 to 2.8	2.8 to 3.3	3.3 to 4.0	4.0 to 4.8	4.8 to 5.8	5.8 to 7.0	7.0 to 8.5	8.5 to 10.2	10.2 to 12.3	12.3 to 14.8	14.8 to 19	19 to 21.8	21.8 to 24.5	24.5 to 27.2	27.2 to 29.3	29.3 to 32.6	32.6 to 35.4
SMLK18WBJAW																	
SMLK18WBJBW																	
SMLK18WBJCW																	
SMLK18WBJDW																	
SMLK28WBJCW																	

●Chromaticity Diagram

SMLK18WBJAW

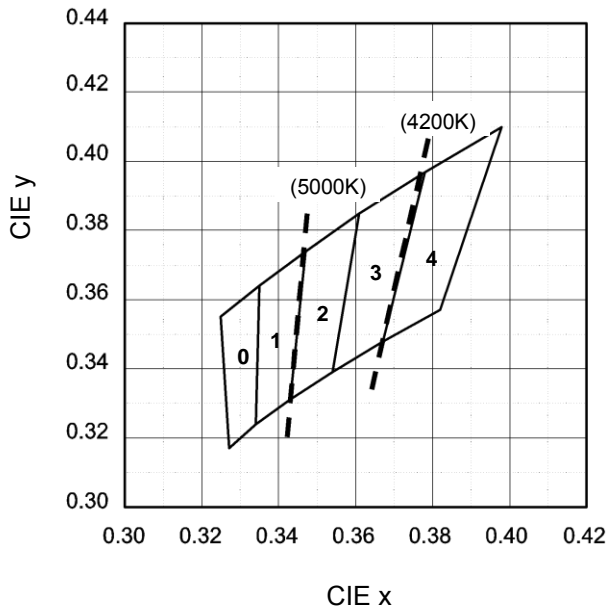

[Chromaticity Coordinates] (Ta=25°C, If=90mA)

0		1		2	
x	y	x	y	x	y
0.335	0.364	0.347	0.374	0.361	0.385
0.334	0.324	0.343	0.331	0.354	0.339
0.327	0.317	0.334	0.324	0.343	0.331
0.325	0.355	0.335	0.364	0.347	0.374

3		4	
x	y	x	y
0.378	0.397	0.398	0.410
0.367	0.348	0.382	0.357
0.354	0.339	0.367	0.348
0.361	0.385	0.378	0.397

Measurement tolerance : ±0.01

SMLK18WBJBW

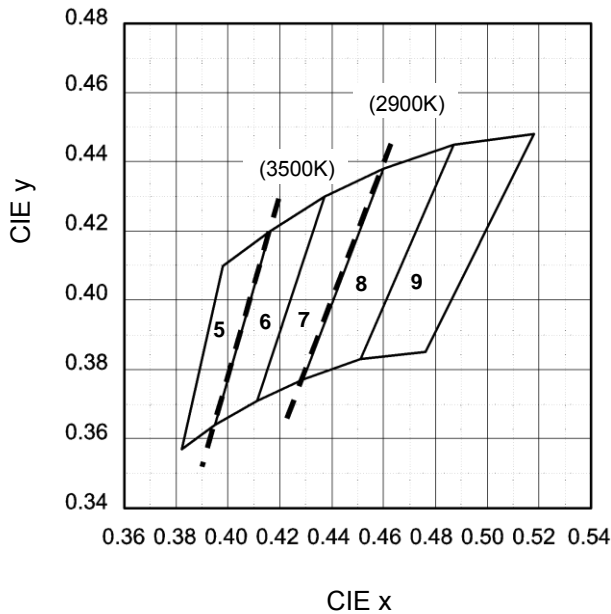

[Chromaticity Coordinates] (Ta=25°C, If=90mA)

5		6		7	
x	y	x	y	x	y
0.416	0.420	0.437	0.430	0.460	0.438
0.395	0.364	0.411	0.371	0.429	0.377
0.382	0.357	0.395	0.364	0.411	0.371
0.398	0.410	0.416	0.420	0.437	0.430

8		9	
x	y	x	y
0.487	0.445	0.518	0.448
0.451	0.383	0.476	0.385
0.429	0.377	0.451	0.383
0.460	0.438	0.487	0.445

Measurement tolerance : ±0.01

●Chromaticity Diagram

SMLK18WBJCW
SMLK28WBJCW

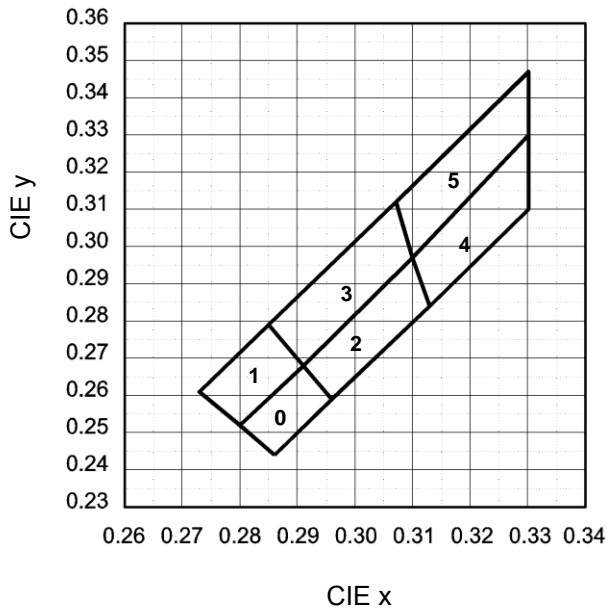

[Chromaticity Coordinates] (Ta=25°C, If=90mA)

0		1		2	
x	y	x	y	x	y
0.286	0.244	0.280	0.252	0.296	0.259
0.280	0.252	0.273	0.261	0.291	0.268
0.291	0.268	0.285	0.279	0.310	0.297
0.296	0.259	0.291	0.268	0.313	0.284

3		4		5	
x	y	x	y	x	y
0.291	0.268	0.313	0.284	0.310	0.297
0.285	0.279	0.310	0.297	0.307	0.312
0.307	0.312	0.330	0.330	0.330	0.347
0.310	0.297	0.330	0.310	0.330	0.330

Measurement tolerance : ±0.01

SMLK18WBJDW

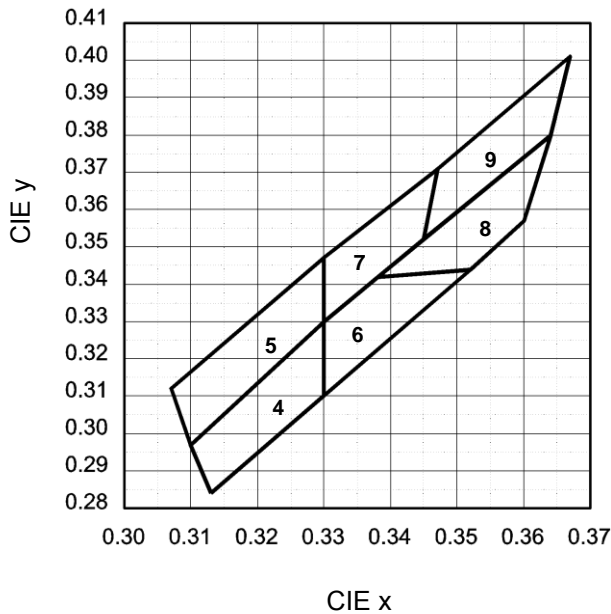

[Chromaticity Coordinates] (Ta=25°C, If=90mA)

4		5		6	
x	y	x	y	x	y
0.313	0.284	0.310	0.297	0.330	0.310
0.310	0.297	0.307	0.312	0.330	0.330
0.330	0.330	0.330	0.347	0.338	0.342
0.330	0.310	0.330	0.330	0.352	0.344

7		8		9	
x	y	x	y	x	y
0.330	0.330	0.352	0.344	0.345	0.352
0.330	0.347	0.338	0.342	0.347	0.371
0.347	0.371	0.364	0.380	0.367	0.401
0.345	0.352	0.360	0.357	0.364	0.380

Measurement tolerance : ±0.01

●Taping (SMLK2 * Series)

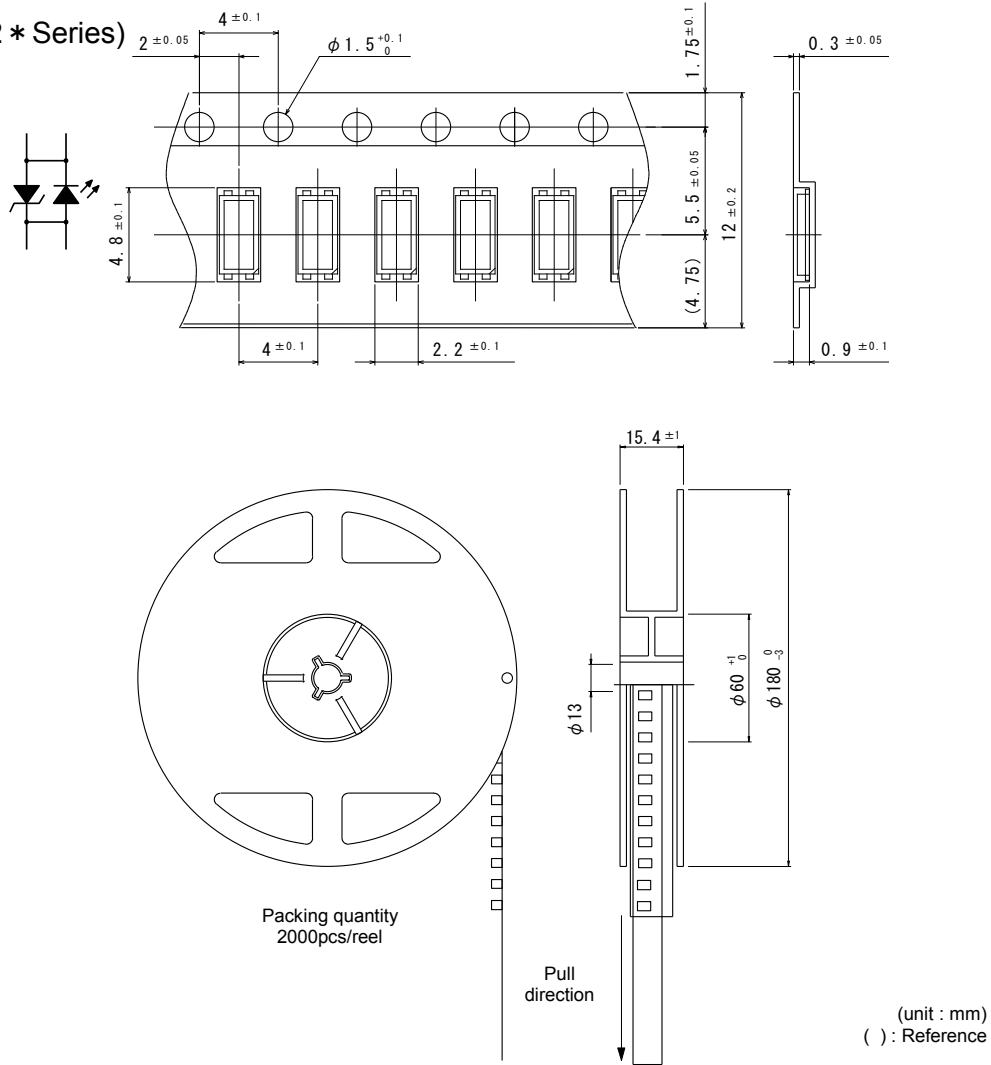

(Note) Tolerance is ±0.2mm, unless otherwise specified.

●Part No. Construction

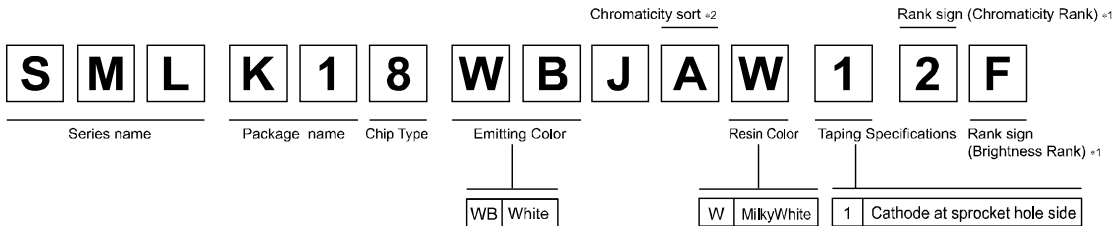

- *1: Concerning the Brightness rank
- Please refer to the rank chart above for luminous intensity classification.
- Please refer to the Specification sheet for color classification.
- Part name is individual for each rank.
- When shipped as sample, the part name will be a representative part name.
- General products are free of ranks. Please contact sales if rank appointment is needed.

*2: Please refer to Chromaticity diagram.

●Packing Specification

ROHM LED products are being shipped with desiccant (silica gel) concluded in moisture-proof bags.

Pasting the moisture sensitive label on the outer surface of the moisture-proof bags or enclosing the humidity indication card inside the bag is available upon request.

Please contact the nearest sales office or distributor if necessary.

●Attention Points In Handling

This product was developed as a surface mount LED especially suitable for reflow soldering. Please take care of following points when using this device.

1.DESIGNING OF PCB

As for a recommendable solder pattern, Please refer to Fig-1.
 The size and direction of the pad pattern depend on the condition of the PCB. so, please investigate about the adjustment thoroughly before designing.
 (n.b) Performance/characteristics of devise shall considerably differ depending on mounting conditions. That is to say, the optimized heat-radiation mounting will make best use of device's performance. Thus, it in recommended to design the land pattern with use of Cu for a great deal of heat-radiation as well as the use of metal mounting board.)

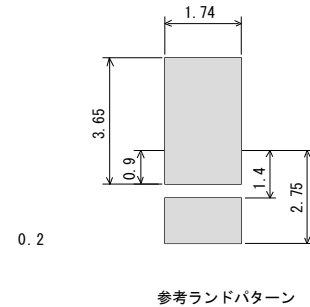

(Fig-1)

2.SOLDERING

LED products do not contain reinforcement materials such as glass fillers. Therefore, thermal stress by soldering greatly influence its reliability. The temperature conditions for reflow soldering should therefore be set up according to the characteristic of this product. (See Fig-2)
 Number of reflow process shall be max 2 times and these processes shall be performed in a row. Cooling process to normal temperature shall be required between first and second soldering process.

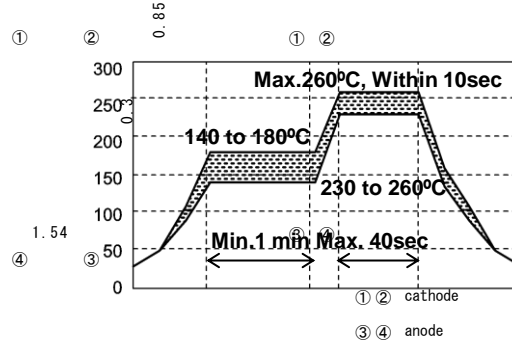

(Fig-2)

3.USE OF AUTOMATIC MOUNTING MACHINE

As for this product, the silicone resin is used as encapsulate material and the sealing part on top of LED is soft. Therefore, please make sure not to apply the pressure upon it, as it might influence reliability. Moreover, please use the adsorption nozzle when you use the automatic mounting machine so as not to apply the force directly to this top sealing part.

4.HANDLING AFTER MOUNTING

As shown right drawing, in case outside force is given to the device, stress is concentrated to the jointed part between mold resin and substrate. Therefore there is a possibility to breath the device or PCB. Careful handling is needed as ROHM cannot guarantee the falling of the device by outside force after mounting.

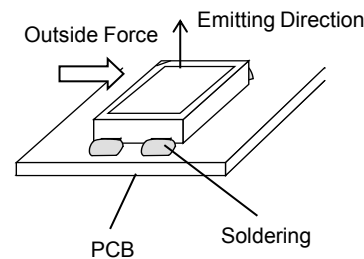

5. WASHING

Please note the following points when washing is required after soldering.

5-1) WASHING SOLVENT

Isopropyl alcohol or other alcohol solvent is recommendable.

5-2) TEMPERATURE

Below 30°C, immersion time ; within 3 minutes.

5-3) ULTRA SONIC WASHING

Below 15W/1 litter of solvent tub or less.

5-4) COOLING

Below 100°C within 3 minutes.

6. HEAT-RADIATION DESIGN

Pluses of luminous intensity under continuous load varies depending on the ambient temperature.

Therefore, it is requested that enough heat – radiation designing be conducted for mounting.

Also, please consider derating features for the setting drive current.

7. EROSION GAS

Utilization in erosion gas atmosphere may degenerate the plating surface which might cause deterioration of solder strength, optical characteristics, or functions.

Please take precautions against occurrence of gas from the surrounding parts on the occasion of custody, and also after mounted on circuit board.

8. STORAGE

At reflow soldering, the reliability of this product is often influenced by moisture absorption so we apply the packaging with moisture proof for better condition is use, please also note that

8-1) Not to be opened before using.

8-2) To be kept in our moisture proof packaging with some desiccant (SILICA GEL) after opening it.

To be baked in case the SILICA GEL indicator changed its color from either blue to clear or green to pink.

8-3) Please use within 72 hours after the package was opened. (Condition at 30°C, max.70%Rh.)

In case it is not used within 72 hours, please put it back into our packaging.

8-4) BAKING

Please bake under reel condition at 60°C, 40~48 hours (max.20%Rh) after un-sealing.

While baking is done, the reel and emboss tape may be easily deformed.

Please be careful not to give any stress.

9. LIFE TIME

This product will cause reduction of luminous intensity depending on the using conditions and environmental.

Please inquire our sales contact if long life time is required on your application.

Notes

- 1) The information contained herein is subject to change without notice.
- 2) Before you use our Products, please contact our sales representative and verify the latest specifications :
- 3) Although ROHM is continuously working to improve product reliability and quality, semiconductors can break down and malfunction due to various factors.
Therefore, in order to prevent personal injury or fire arising from failure, please take safety measures such as complying with the derating characteristics, implementing redundant and fire prevention designs, and utilizing backups and fail-safe procedures. ROHM shall have no responsibility for any damages arising out of the use of our Products beyond the rating specified by ROHM.
- 4) Examples of application circuits, circuit constants and any other information contained herein are provided only to illustrate the standard usage and operations of the Products. The peripheral conditions must be taken into account when designing circuits for mass production.
- 5) The technical information specified herein is intended only to show the typical functions of and examples of application circuits for the Products. ROHM does not grant you, explicitly or implicitly, any license to use or exercise intellectual property or other rights held by ROHM or any other parties. ROHM shall have no responsibility whatsoever for any dispute arising out of the use of such technical information.
- 6) The Products are intended for use in general electronic equipment (i.e. AV/OA devices, communication, consumer systems, gaming/entertainment sets) as well as the applications indicated in this document.
- 7) The Products specified in this document are not designed to be radiation tolerant.
- 8) For use of our Products in applications requiring a high degree of reliability (as exemplified below), please contact and consult with a ROHM representative : transportation equipment (i.e. cars, ships, trains), primary communication equipment, traffic lights, fire/crime prevention, safety equipment, medical systems, servers, solar cells, and power transmission systems.
- 9) Do not use our Products in applications requiring extremely high reliability, such as aerospace equipment, nuclear power control systems, and submarine repeaters.
- 10) ROHM shall have no responsibility for any damages or injury arising from non-compliance with the recommended usage conditions and specifications contained herein.
- 11) ROHM has used reasonable care to ensure the accuracy of the information contained in this document. However, ROHM does not warrant that such information is error-free, and ROHM shall have no responsibility for any damages arising from any inaccuracy or misprint of such information.
- 12) Please use the Products in accordance with any applicable environmental laws and regulations, such as the RoHS Directive. For more details, including RoHS compatibility, please contact a ROHM sales office. ROHM shall have no responsibility for any damages or losses resulting from non-compliance with any applicable laws or regulations.
- 13) When providing our Products and technologies contained in this document to other countries, you must abide by the procedures and provisions stipulated in all applicable export laws and regulations, including without limitation the US Export Administration Regulations and the Foreign Exchange and Foreign Trade Act.
- 14) This document, in part or in whole, may not be reprinted or reproduced without prior consent of ROHM.



Thank you for your accessing to ROHM product informations.
More detail product informations and catalogs are available, please contact us.

ROHM Customer Support System

<http://www.rohm.com/contact/>