

LT1□□82A series

3.3×2.9mm, 1.1mm Thickness, High-luminosity, Dichromatic Chip LED Devices with Lens

Outline Dimensions

(Unit : mm)

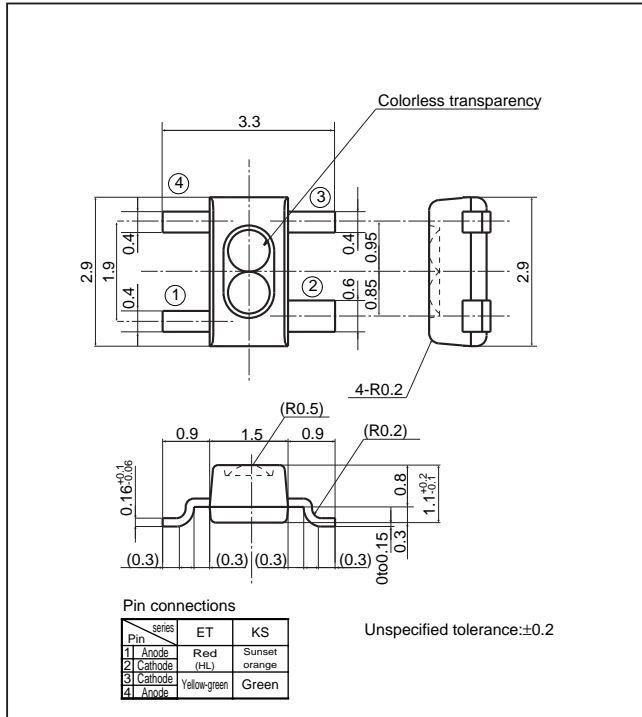

Radiation Diagram

(Ta=25°C)

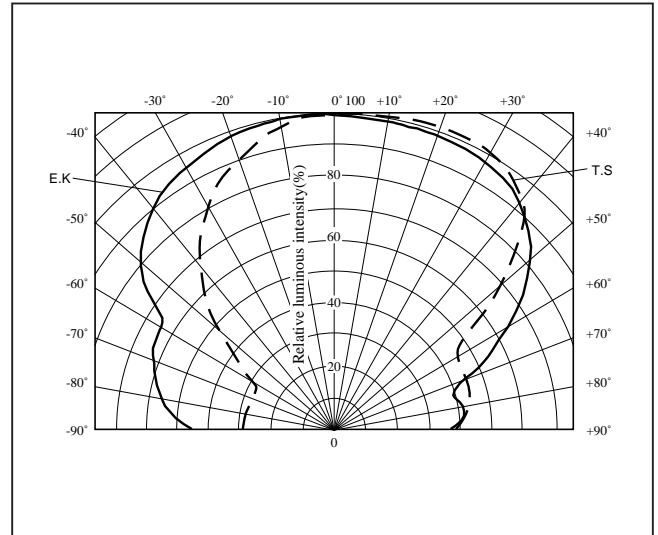

Absolute Maximum Ratings*

(Ta=25°C)

Model No.	Radiation color	Radiation material	Power dissipation P (mW)	Forward current IF (mA)	Peak forward current IFM*1 (mA)	Derating factor (mA/°C)		Reverse voltage VR (V)	Operating temperature Topr (°C)	Storage temperature Tstg (°C)	Soldering temperature Tsol*2 (°C)
						DC	Pulse				
LT1ET82A	Yellow-green	GaP	50	20	50	0.27	0.67	5	-25 to +85	-25 to +100	350
	Red(High-luminosity)	GaAlAs on GaAs	66	30	50	0.40	0.67	5	-25 to +85	-25 to +100	350
LT1KS82A	Green	GaP	50	20	50	0.27	0.67	5	-25 to +85	-25 to +100	350
	Sunset orange	GaAsP on GaP	85	30	50	0.40	0.67	5	-25 to +85	-25 to +100	350

* The value is specified under the condition that either color is lightened separately. When the both diodes are lightened simultaneously, the power dissipation of each diode should be less than the half of the value specified in this table.

*1 Duty ratio=1/10, Pulse width=0.1ms

*2 For 3s or less at the temperature of hand soldering. Temperature of reflow soldering is shown on the below page.

Electro-optical Characteristics

(Ta=25°C)

Lens type	Model No.	Radiation color	Forward voltage VF(V)		Peak emission wavelength		Luminous intensity		Spectrum radiation bandwidth		Reverse current		Terminal capacitance		Page for characteristics diagrams
			TYP	MAX	λp(nm)	IF (mA)	Iv(mcd)	IF (mA)	Δλ(nm)	IF (mA)	IR(μA)	VR (V)	Ct(pF)	(MHz)	
Colorless transparency	LT1ET82A	Yellow-green	1.95	2.5	565	10	7.0	10	30	10	10	4	35	1	→
		Red(High-luminosity)	1.75	2.2	660	20	11.8	20	20	20	10	4	30	1	→
	LT1KS82A	Green	1.95	2.5	555	10	2.4	10	25	10	10	4	40	1	→
		Sunset orange	2.0	2.8	610	20	10.5	20	35	20	10	4	15	1	→

(Notice) • In the absence of confirmation by device specification sheets, SHARP takes no responsibility for any defects that may occur in equipment using any SHARP devices shown in catalogs, data books, etc. Contact SHARP in order to obtain the latest device specification sheets before using any SHARP device.

(Internet) • Data for sharp's optoelectronic/power device is provided for internet.(Address <http://www.sharp.co.jp/ecg/>)

LED Lamp Characteristics Diagrams

EG series

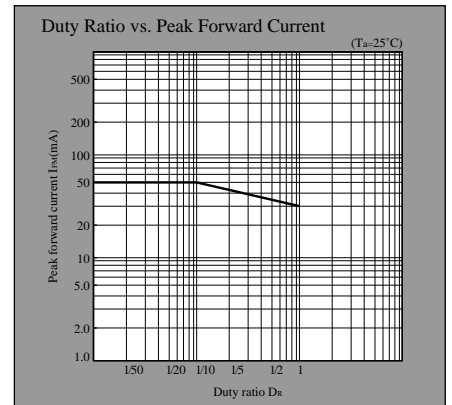
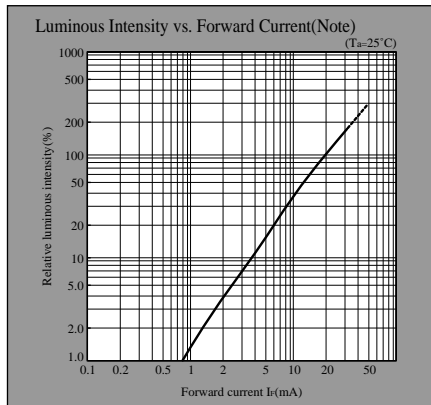
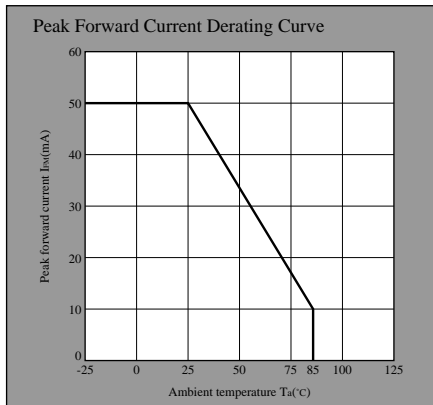
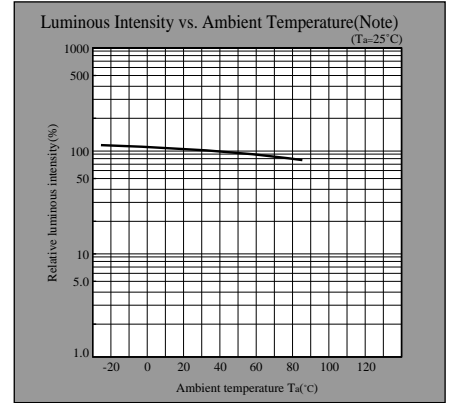
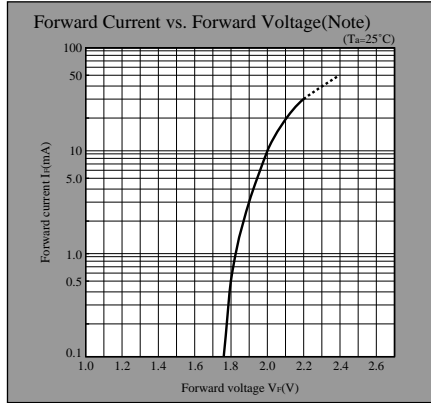
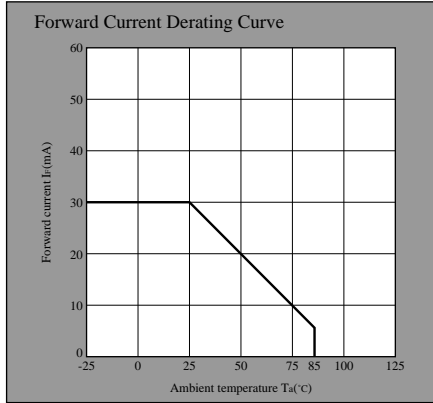

KG series

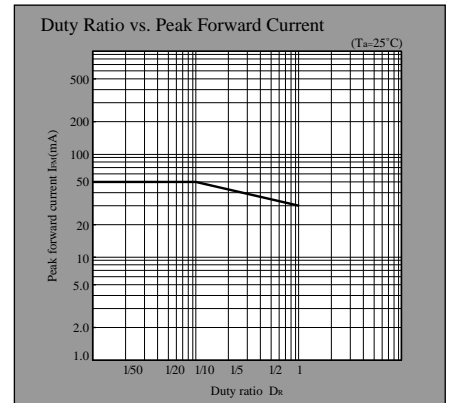
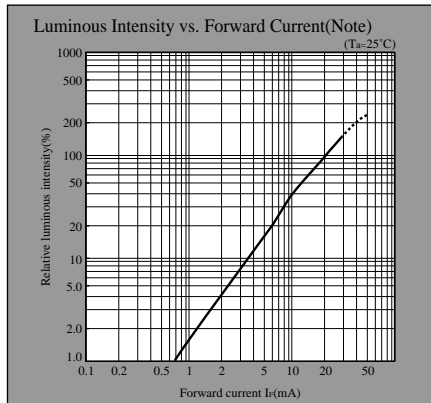
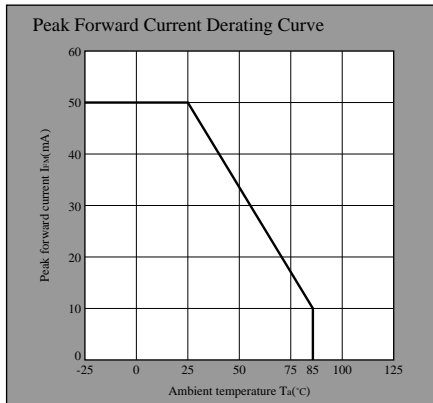
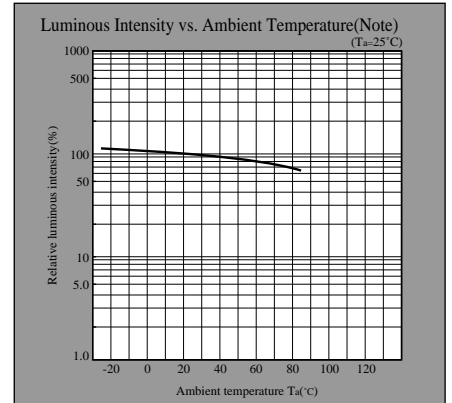
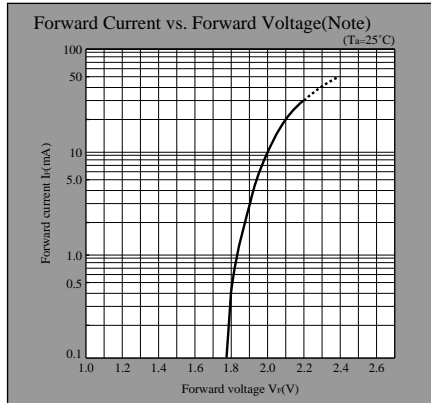
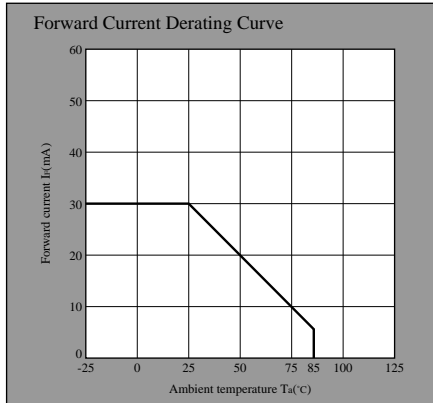

Note) Characteristics shown in diagrams are typical values. (not assurance value)

- (Notice) • In the absence of confirmation by device specification sheets, SHARP takes no responsibility for any defects that may occur in equipment using any SHARP devices shown in catalogs, data books, etc. Contact SHARP in order to obtain the latest device specification sheets before using any SHARP device.
 (Internet) • Data for sharp's optoelectronic/power device is provided for internet.(Address <http://www.sharp.co.jp/ecg/>)

TR series

Forward Current Derating Curve

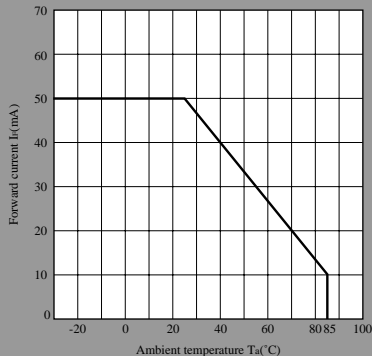

Forward Current vs. Forward Voltage(Note)

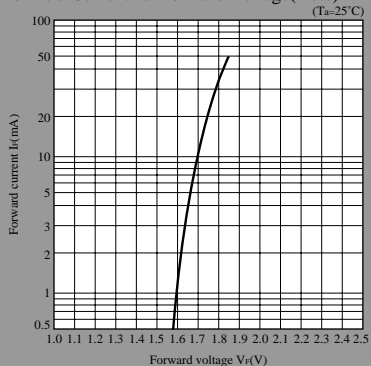

Luminous Intensity vs. Ambient Temperature(Note)

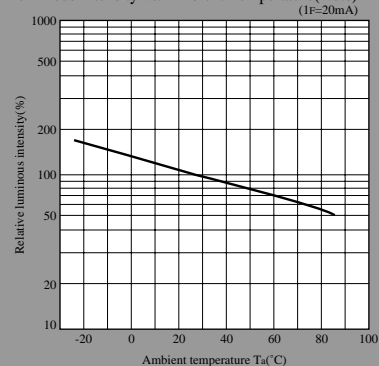

Peak Forward Current Derating Curve

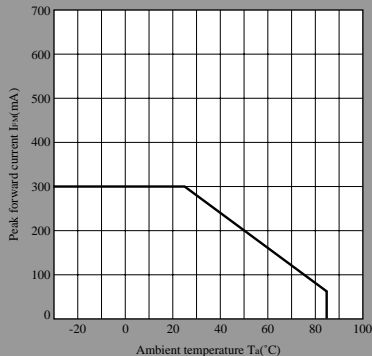

Luminous Intensity vs. Forward Current(Note)

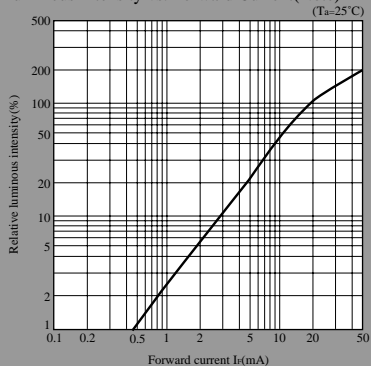

Duty Ratio vs. Peak Forward Current

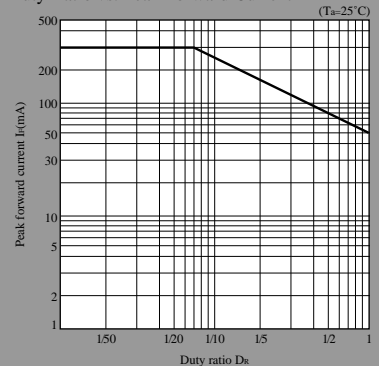

Note) Characteristics shown in diagrams are typical values. (not assurance value)

HS series

Forward Current Derating Curve

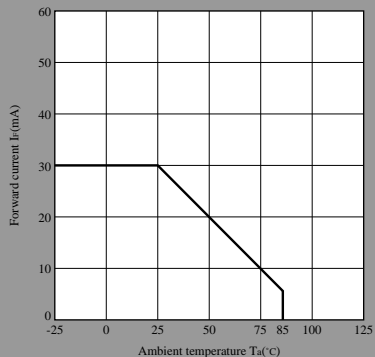

Forward Current vs. Forward Voltage(Note)

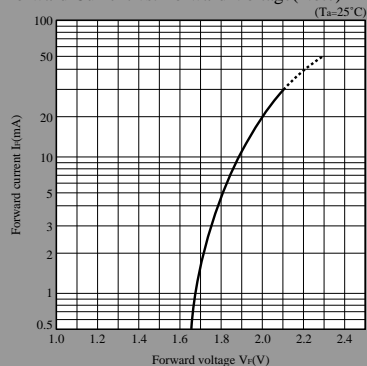

Luminous Intensity vs. Ambient Temperature(Note)

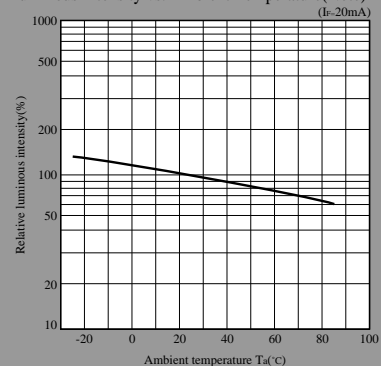

Peak Forward Current Derating Curve

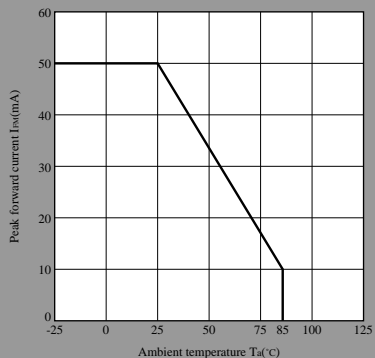

Luminous Intensity vs. Forward Current(Note)

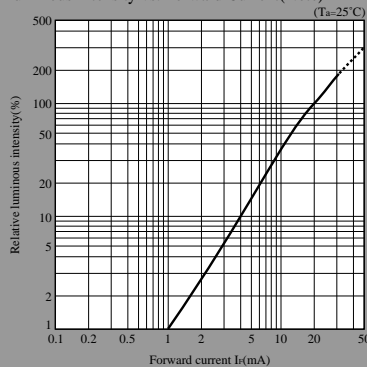

Duty Ratio vs. Peak Forward Current

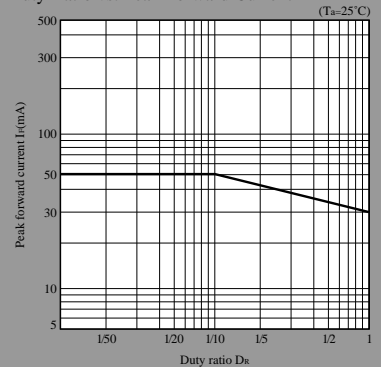

Note) Characteristics shown in diagrams are typical values. (not assurance value)

This datasheet has been download from:

www.datasheetcatalog.com

Datasheets for electronics components.