



**Pb-free
HEAT**



1314C Series

Top View Type Tri-color

Features

Package	Top View Type, Milky White Resin
Product features	<ul style="list-style-type: none"> • Outer Dimension 1.6 x 1.5 x 0.4 mm(L x W x H) • Temperature range. Storage Temperature : -40°C~100°C Operating Temperature : -40°C~ 85°C • No lead package and lead-free soldering compatible • RoHS compliant
Dominant wavelength	Blue : 470nm (UB) Green : 525nm (UG) Yellow Green : 572nm (YPY) Orange : 605nm (FA) Red : 626nm (FR)
Half Intensity Angle	UB/UG/YPY : $\theta_x=135$ deg., FA/FR : $\theta_x=150$ deg. UB/UG/YPY/FA/FR : $\theta_y=145$ deg.
Die materials	UB,UG : InGaN, YPY,FA,FR : AlGaInP
Rank grouping parameter	Sorted by luminous intensity and wavelength per rank taping
Assembly method	Auto pick & place machine (Auto Mounter)
Soldering methods	Reflow soldering and manual soldering
Taping and reel	4,000pcs per reel in a 8mm width tape. (Standard) Reel diameter: ϕ 180mm
ESD	1kV (HBM)

Recommended Applications

Cellular Phone, Mobile Equipment

Color Variations and Luminous Intensity

(Ta=25°C)

Part No.	Die Name	Material	Emitted Color	Lens Color	Dominant Wavelength		Luminous Intensity		
					λd (nm)		I_v (mcd)		
					TYP.	I_F	MIN.	TYP.	I_F
UAGB1314C	UB	InGaN	Blue	Milky White	470	10	15	30	10
	UG	InGaN	Green		525	10	60	140	10
	FA	AlGaInP	Orange		605	10	30	60	10
URGB1314C	UB	InGaN	Blue	Milky White	470	10	15	30	10
	UG	InGaN	Green		525	10	60	140	10
	FR	AlGaInP	Red		626	10	20	40	10
URYB1314C	UB	InGaN	Blue	Milky White	470	10	15	30	10
	YPY	AlGaInP	Yellow Green		572	10	9.6	24	10
	FR	AlGaInP	Red		626	10	20	40	10

※Note : The luminous intensity(I_v) and dominant wavelength(λd) above are the setup values of the sorting machine.
 (Tolerance : $I_v \dots \pm 10\%$, $\lambda d \dots \pm 2nm$)

Absolute Maximum Ratings

(Ta=25°C)

Item	Symbol	Absolute Maximum Ratings					Unit
		UB	UG	YPY	FA	FR	
Power Dissipation	P_d	73	73	62.5	81	81	mW
Forward Current	I_F	20	20	25	30	30	mA
Pulse Forward Current ※1	I_{FRM}	48	48	60	100	100	mA
Derating (Ta=25°C or higher)	ΔI_F	0.28	0.28	0.36	0.43	0.43	mA/°C
	ΔI_{FRM}	0.69	0.69	0.86	1.00	1.00	mA/°C
Reverse Voltage	V_R	5	5	5	5	5	V
Operating Temperature	T_{opr}	-40~+85					°C
Storage Temperature	T_{stg}	-40~+100					°C

 ※1 I_{FRM} Measurement condition : Pulse Width ≤ 1 ms., Duty $\leq 1/20$.

※ The ratings specified above is under the condition that only one diode is lit.

50% Max. of each rating shall be applied when two diodes are lit simultaneously.

30% Max. of each rating shall be applied when all three diodes are lit simultaneously.

Electro-Optical Characteristics (UB,UG,YPY,FA,FR)

(Ta=25°C)

Item	Conditions	Symbol	Characteristics					Unit	
			UB	UG	YPY	FA	FR		
Forward Voltage	I _F =10mA	V _F	TYP.	3.0	3.0	2.0	2.0	2.0	V
			MAX.	3.5	3.5	2.4	2.5	2.5	
Reverse Current	V _R =5V	I _R	MAX.	100	100	100	100	100	μA
Peak Wavelength	I _F =10mA	λ _p	TYP.	465	522	575	609	635	nm
Dominant Wavelength	I _F =10mA	λ _d	TYP.	470	525	572	605	626	nm
Spectral Line Half Width	I _F =10mA	Δλ	TYP.	26	35	17	15	15	nm
Half Intensity Angle	I _F =10mA	2θ _{1/2}	TYP.	135(θ _x)	135(θ _x)	135(θ _x)	150(θ _x)	150(θ _x)	deg.
				145(θ _y)	145(θ _y)	145(θ _y)	145(θ _y)	145(θ _y)	

※Note: The dominant wavelength (λ_d) above is the setup value of the sorting machine.
 (Tolerance: λ_d ... ±2nm)

Luminous Intensity Rank

(Ta=25°C)

Intensity Tolerance each Rank : +/- 10%

Rank	I_v (mcd)																	
	UAGB1313C						URGB1313C						URYB1313C					
	UB		UG		FA		UB		UG		FR		UB		YPY		FR	
	$I_F=10mA$						$I_F=10mA$						$I_F=10mA$					
	MIN.	MAX.	MIN.	MAX.	MIN.	MAX.	MIN.	MAX.	MIN.	MAX.	MIN.	MAX.	MIN.	MAX.	MIN.	MAX.	MIN.	MAX.
A	15	30	60	140	30	60	15	30	60	140	20	40	15	30	9.6	24	20	40
B	30						30						30					
C	15	30	140				15	30	140				15	30	24			
D	30						30						30					
E	15	30	60	140	60		15	30	60	140	40		15	30	10	24	40	
F	30						30						30					
G	15	30	140				15	30	140				15	30	24			
H	30						30						30					

Color Tone Groups (λd)

($T_a=25^\circ\text{C}$)

Tolerance: +/- 2nm

Rank	Dominant Wave Length λd (nm)																	
	UAGB1313C						URGB1313C						URYP1313C					
	UB		UG		FA		UB		UG		FR		UB		YPY		FR	
	$I_f=10\text{mA}$						$I_f=10\text{mA}$						$I_f=10\text{mA}$					
	MIN.	MAX.	MIN.	MAX.	MIN.	MAX.	MIN.	MAX.	MIN.	MAX.	MIN.	MAX.	MIN.	MAX.	MIN.	MAX.	MIN.	MAX.
A	460	480	510	540	595	613	460	480	510	540	615	635	460	480	567	577	615	635

Technical Data(UB)

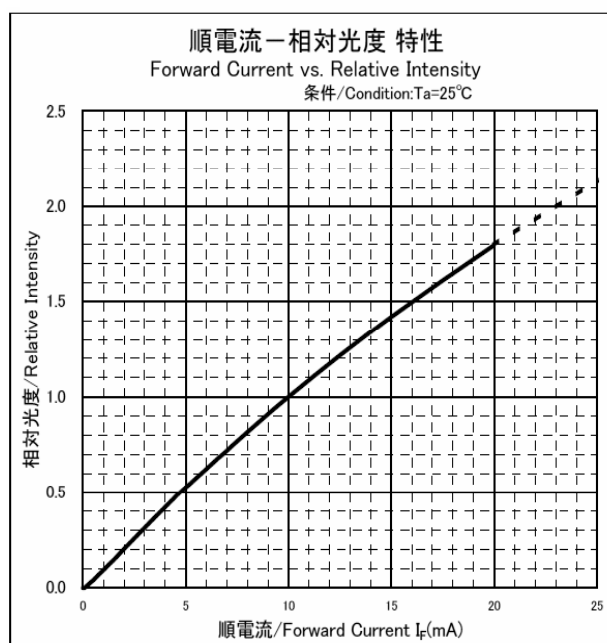
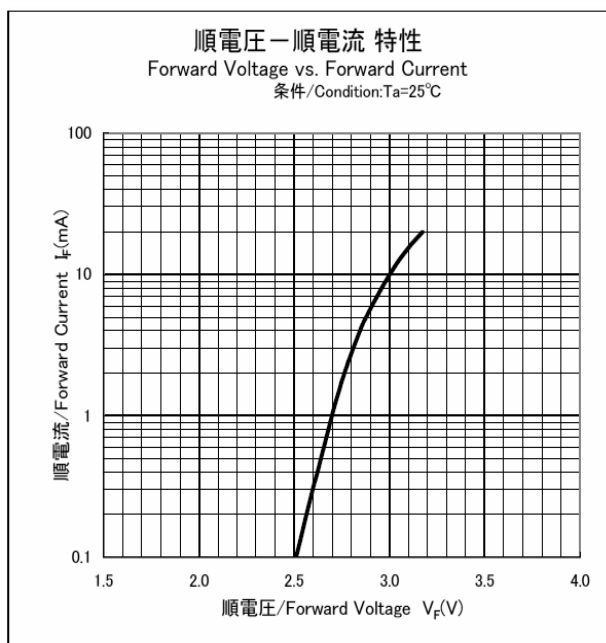
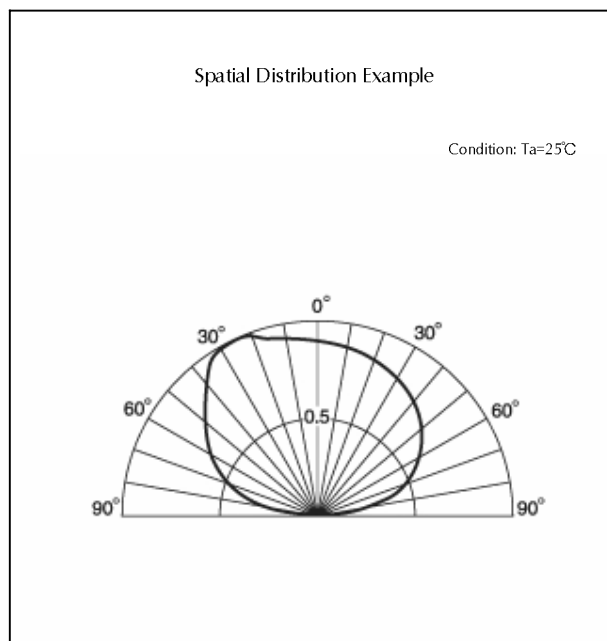
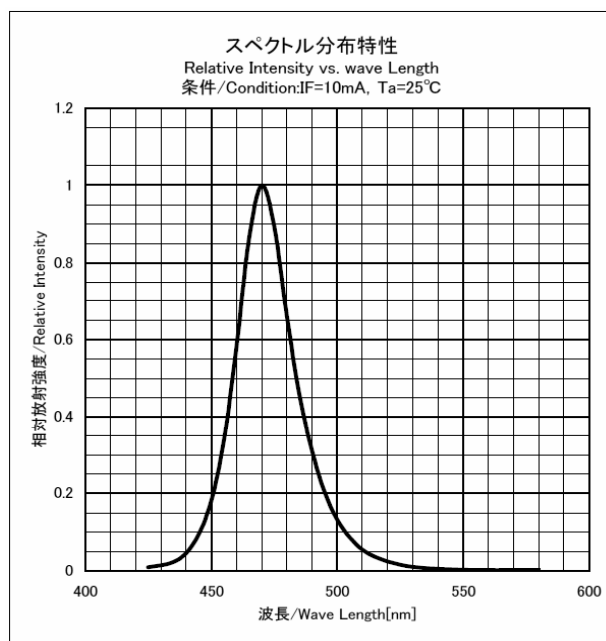

Technical Data(UB)

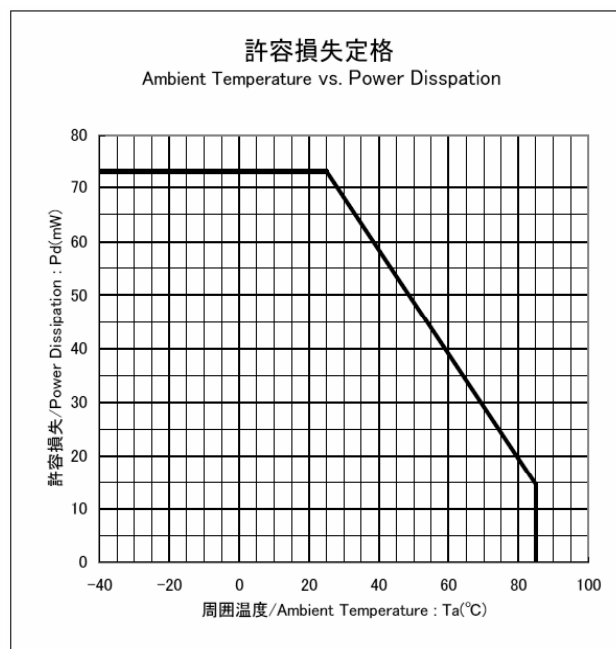
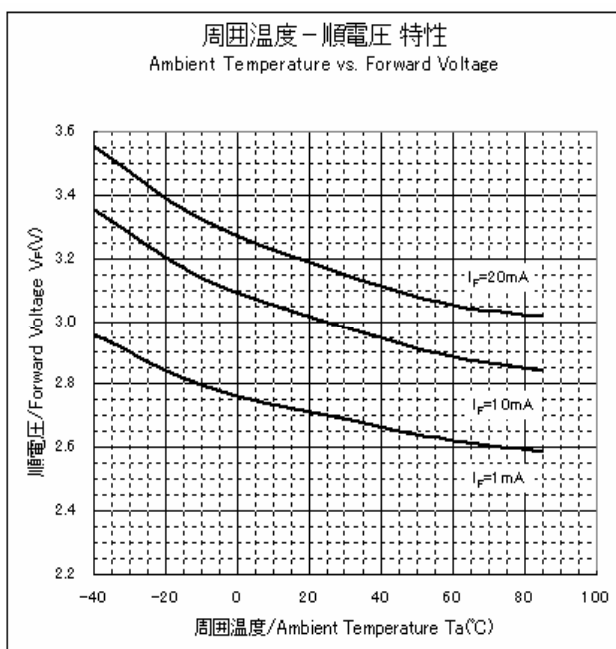
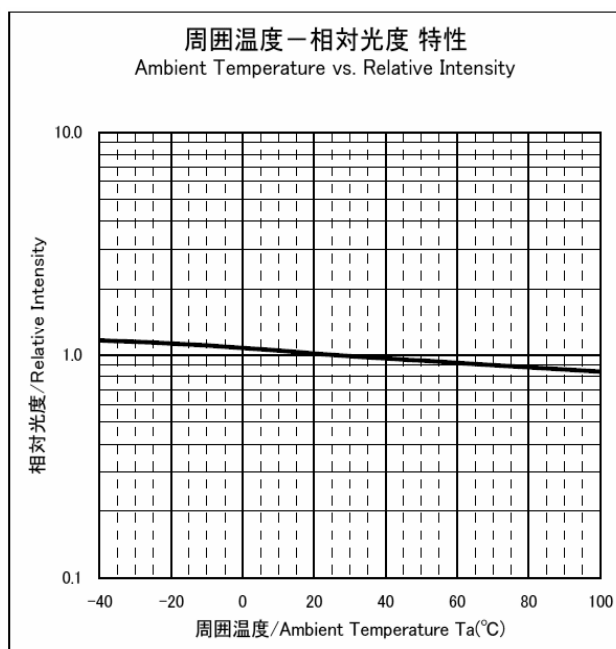
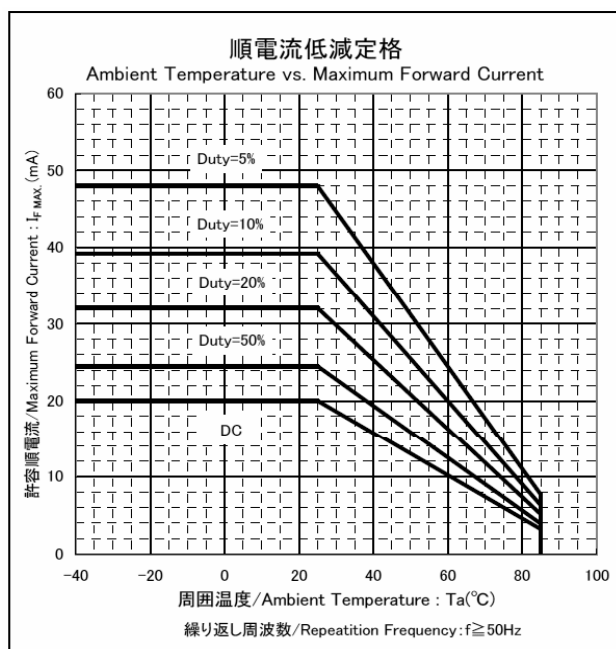

Technical Data(UG)

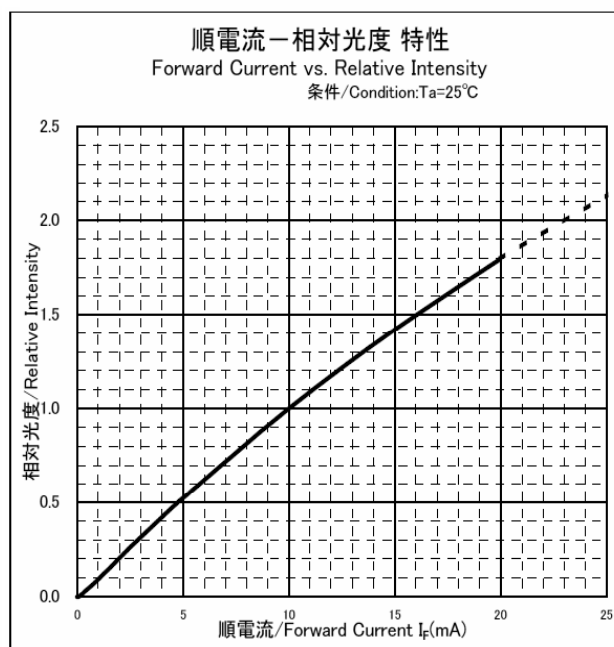
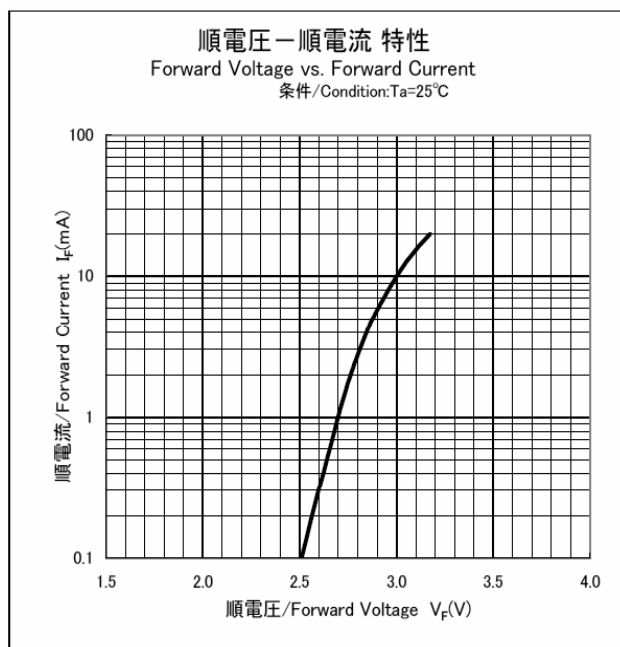
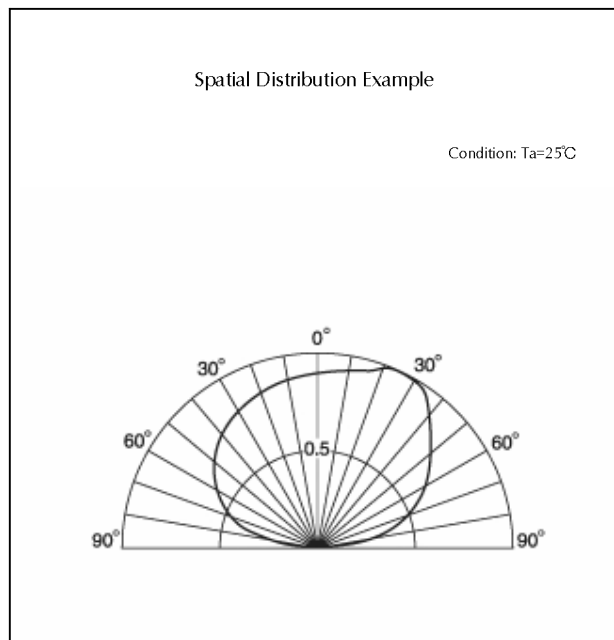
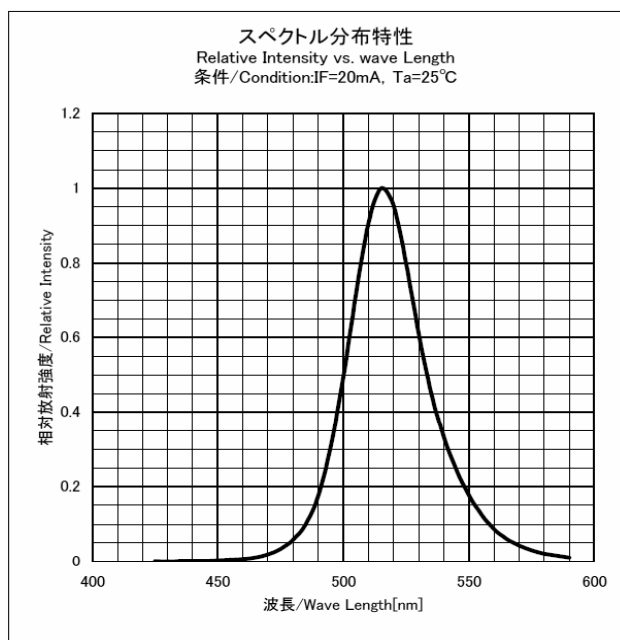

Technical Data(UG)

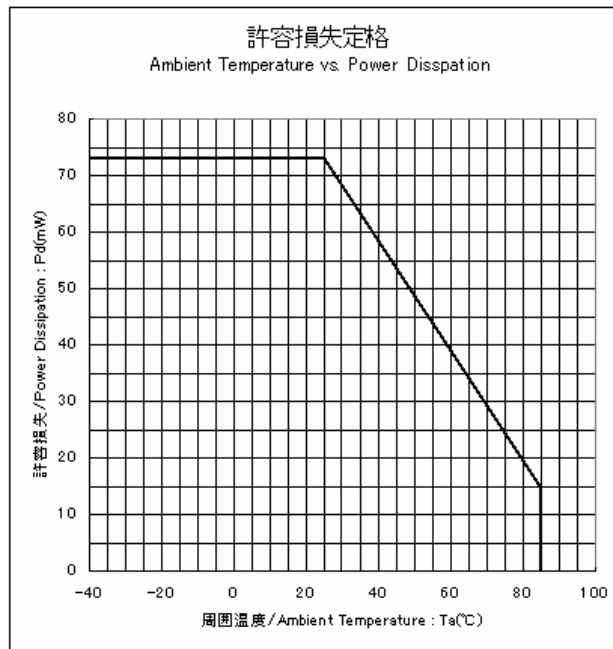
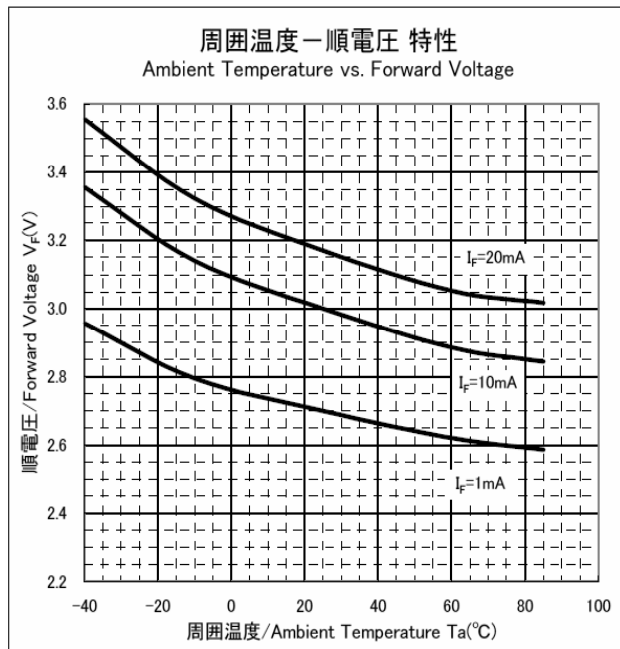
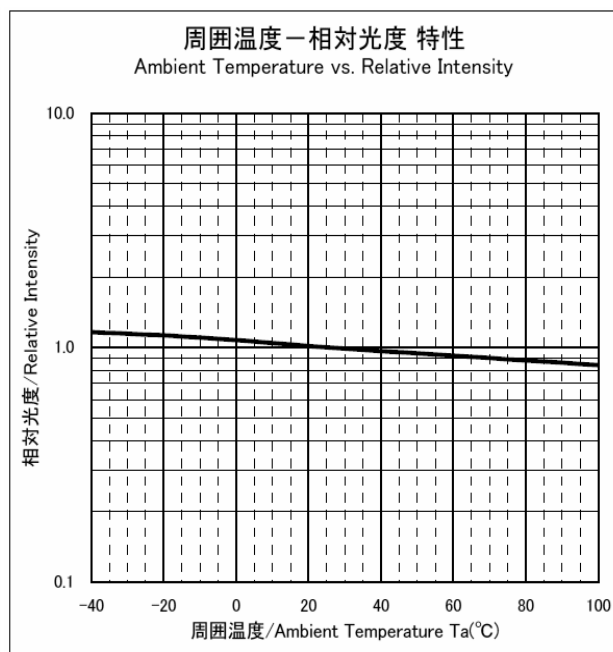
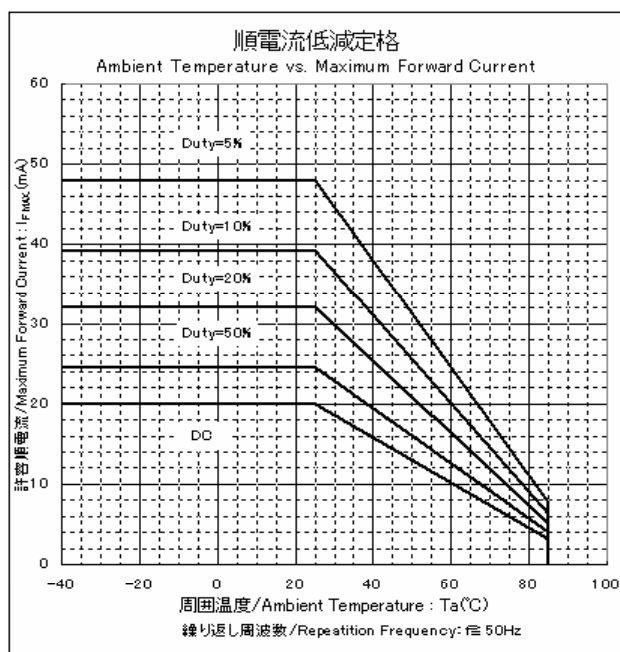

Technical Data (YPY)

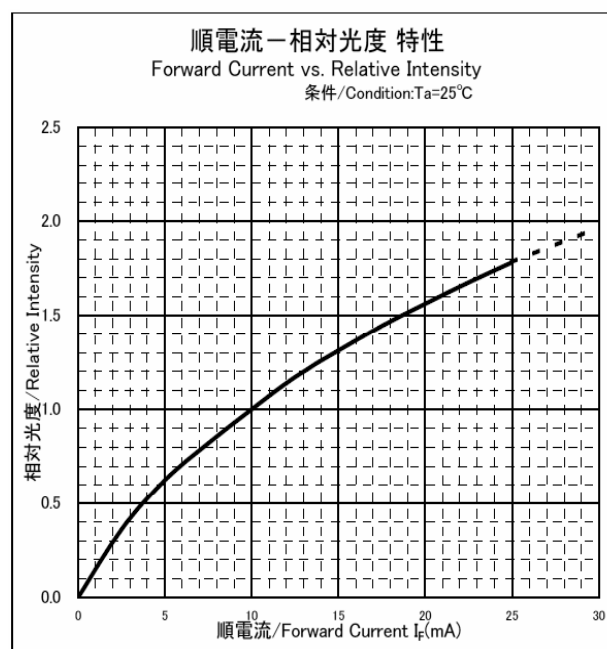
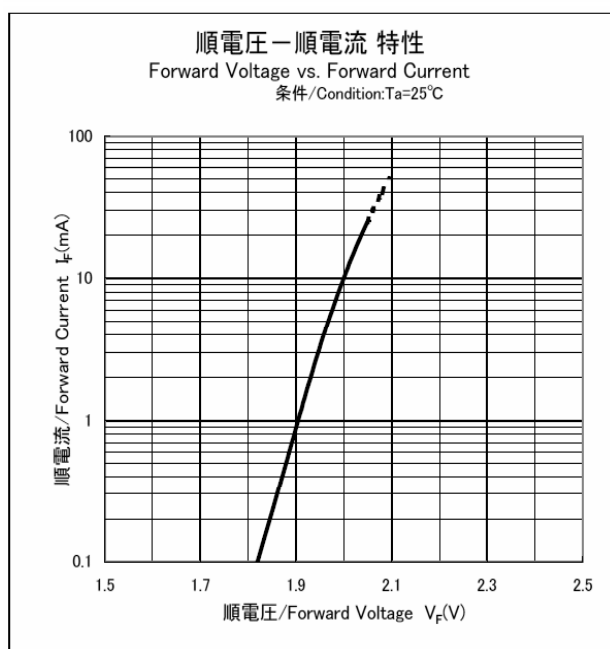
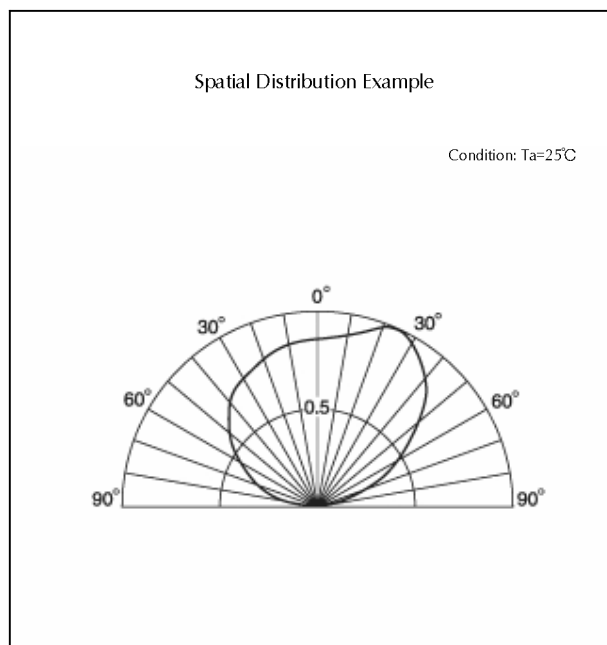
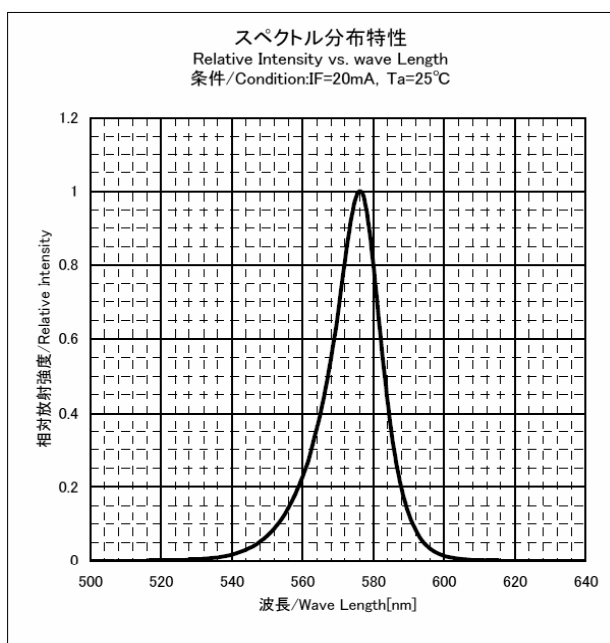

Technical Data (YPY)

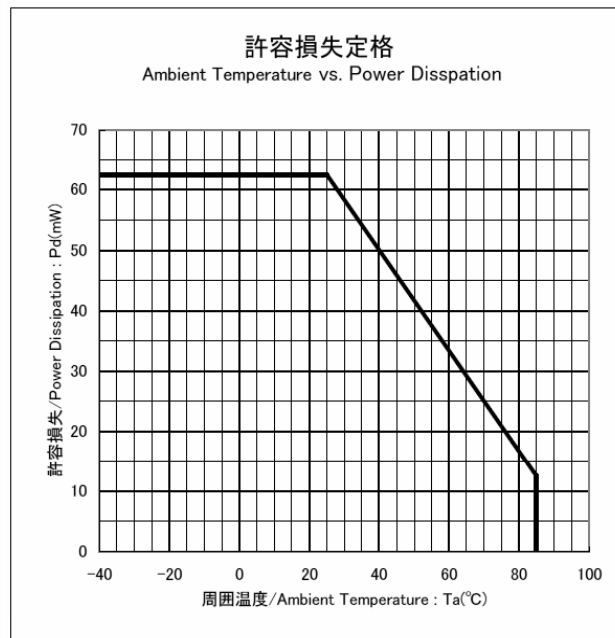
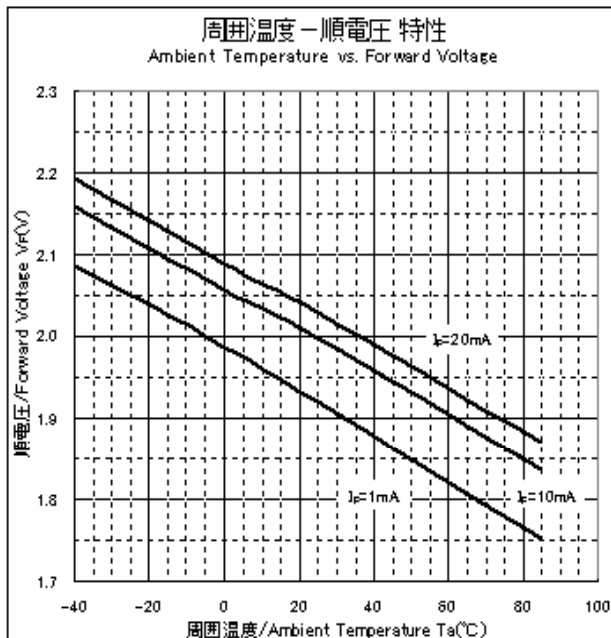
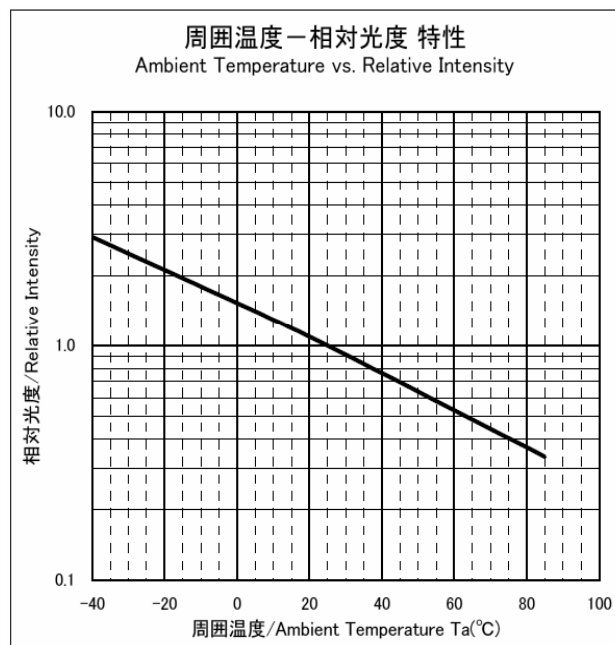
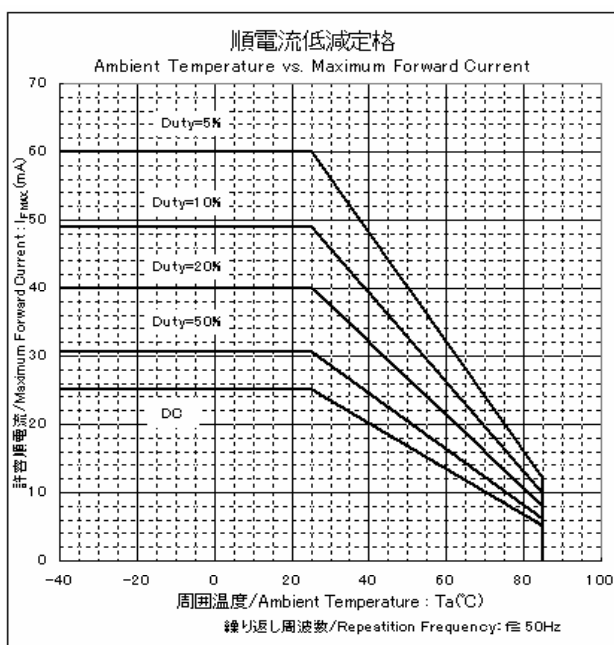

Technical Data(FA/FR)

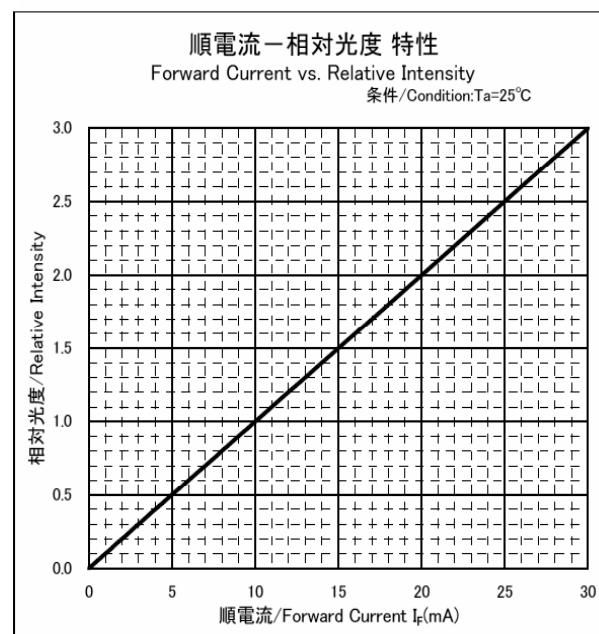
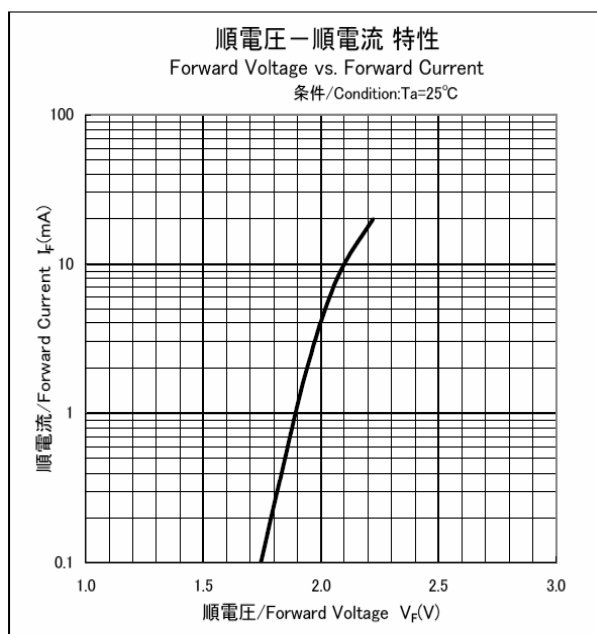
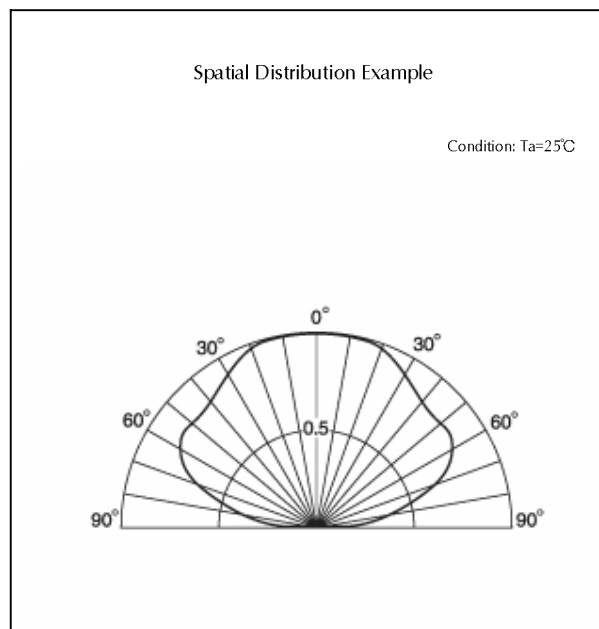
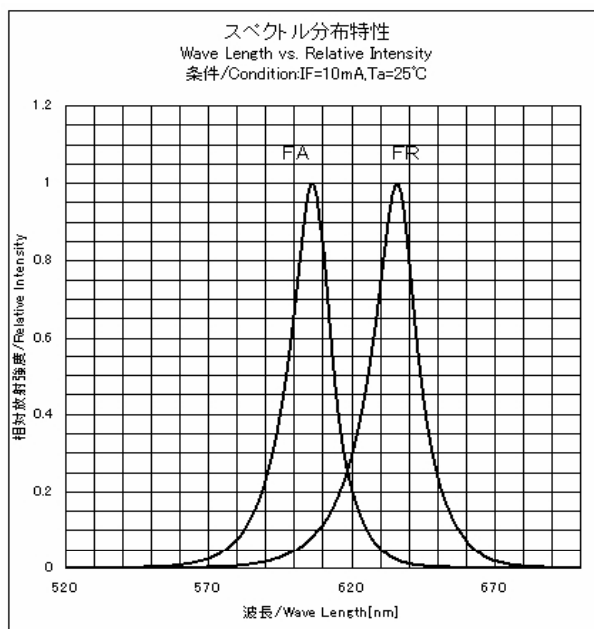

Technical Data(FA/FR)

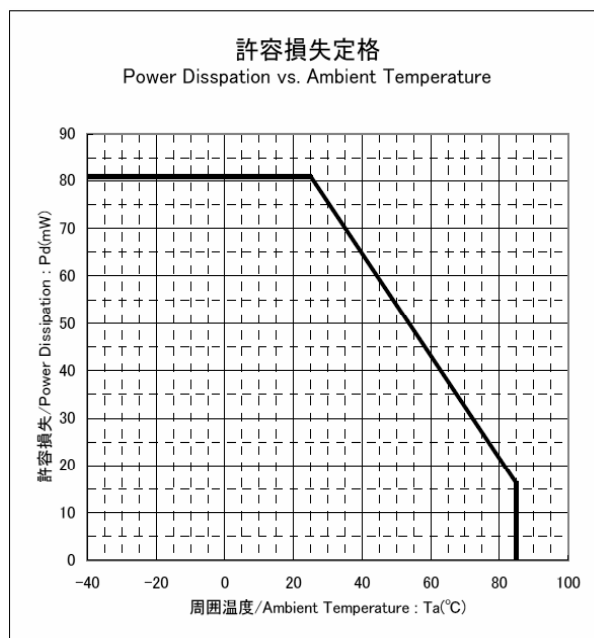
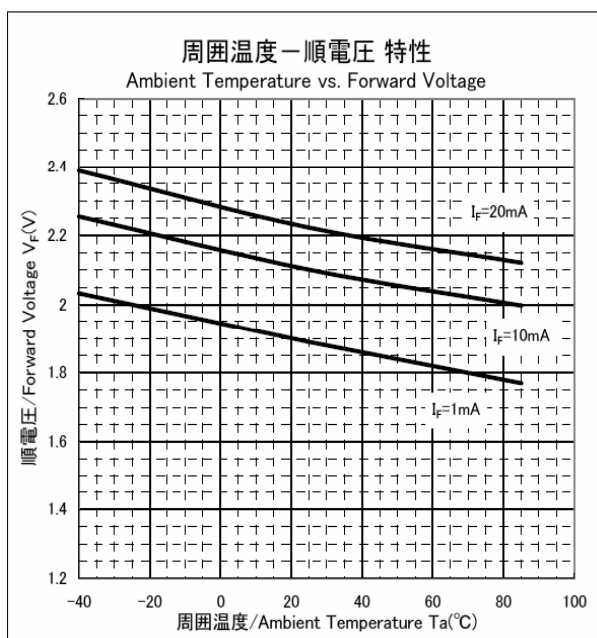
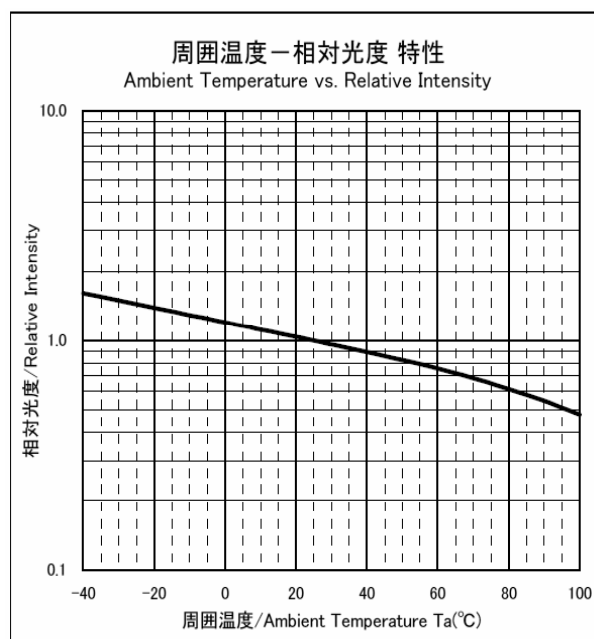
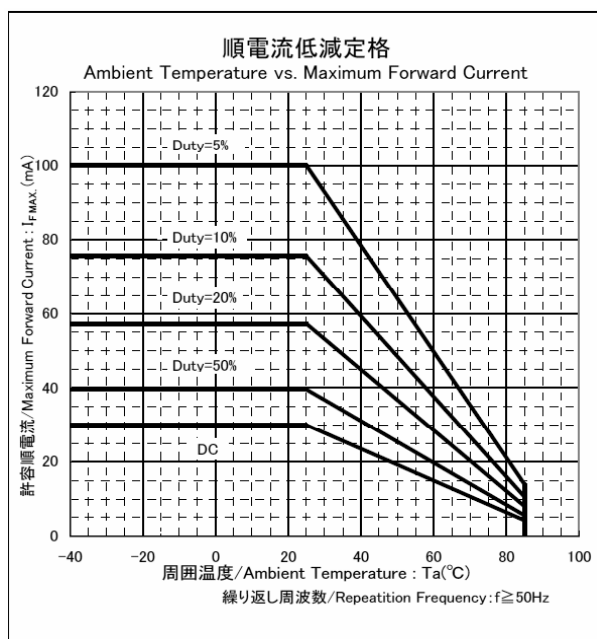

Package Dimensions

(Unit: mm)

Weight:(2.36)mg

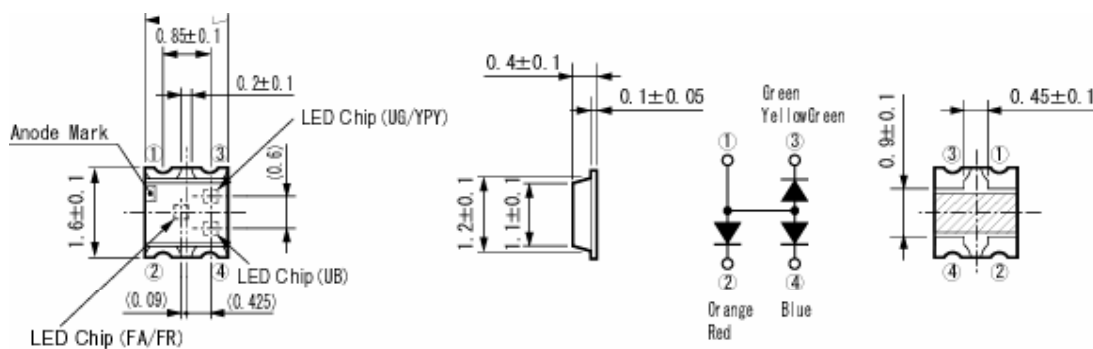

Recommended Soldering Pattern

(Unit: mm)

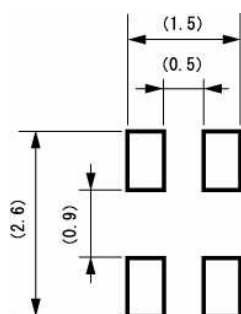

Taping Specification

(Unit: mm)

Quantity: 4,000pcs/ reel (standard)

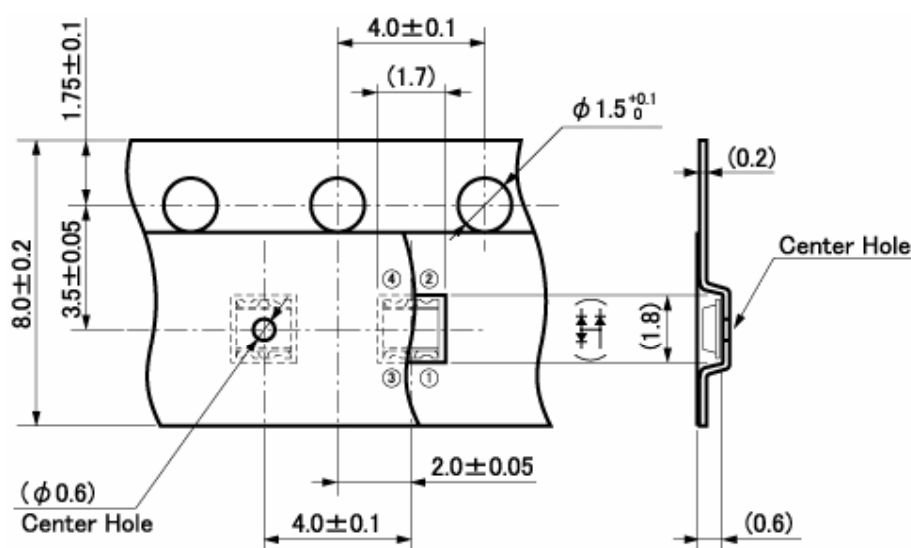

Reflow Soldering Conditions

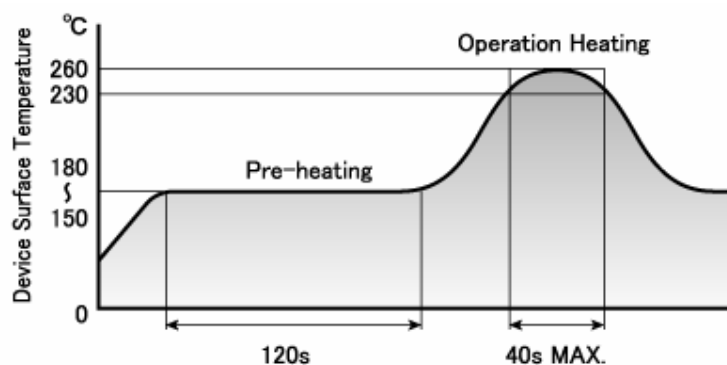

- 1) The above profile temperature gives the maximum temperature of the LED resin surface. Please set the temperature so as to avoid exceeding this range.
- 2) Total times of reflow soldering process shall be no more than 2 times. When the second reflow soldering process is performed, intervals between the first and second reflow should be short as possible (while allowing some time for the component to return to normal temperature after the first reflow) in order to prevent the LED from absorbing moisture.
- 3) Temperature fluctuation to the LED during the pre-heating process shall be minimized. (6°C maximum)

Manual Soldering Conditions

Iron tip temp.	350 °C	(MAX.)
Soldering time and frequency	3 s	(MAX.)
	1 time	(MAX.)

Special Notice to Customers Using the Products and Technical Information Shown in This Data Sheet

- 1) The technical information shown in the data sheets are limited to the typical characteristics and circuit examples of the referenced products. It does not constitute the warranting of industrial property nor the granting of any license.
- 2) For the purpose of product improvement, the specifications, characteristics and technical data described in the data sheets are subject to change without prior notice. Therefore it is recommended that the most updated specifications be used in your design.
- 3) When using the products described in the data sheets, please adhere to the maximum ratings for operating voltage, heat dissipation characteristics, and other precautions for use. We are not responsible for any damage which may occur if these specifications are exceeded.
- 4) The products described in the data sheets are made to be used in standard electronic applications such as office automation appliances, communication devices, audio visual, home appliances, and measuring instruments.
- 5) If the products in the data sheets are to be used for purposes other than the above which requires high level reliability and safety where failure and or malfunction of the product may cause death or other serious effects on the human body such as airplane, space activity, transportation, medical, nuclear), please contact our sales personnel.
- 6) In order to export the products or technologies described in this data sheet which are under the "Foreign Exchange and Foreign Trade Control Law," it is necessary to first obtain an export permit from the Japanese government.
- 7) No part of this data sheet may be reprinted or reproduced without prior written permission from Stanley Electric Co., Ltd.
- 8) The most updated edition of this data sheet can be obtained from the address below:
<http://www.stanley-components.com>