



**Pb-free
HEAT**



U□1113F Series

Single Color Ultra High Brightness Type

Features

Package	Right Angle Type (2.1 x 1.0 mm) Type, Milky White resin
Product features	<ul style="list-style-type: none"> • Outer Dimension 2.1 x 1.0 x 0.6mm (L x W x H) • Temperature range Storage Temperature : -40°C~100°C Operating Temperature : -40°C~85°C • Lead-free soldering compatible • RoHS compliant
Dominant wavelength	Blue : 470nm(UB) Blue Green : 508nm(UC) Green : 530nm(UG) Yellow : 590nm(UY) Red : 630nm(UR)
Half Intensity Angle	UB,UC,UG : $\theta_x = 145 \text{ deg.}, \theta_y = 150 \text{ deg.}$ UY,UR : $\theta_x = 146 \text{ deg.}, \theta_y = 154 \text{ deg.}$
Die materials	UB,UC,UG : InGaN, UY,UR : AlGaInP
Rank grouping parameter	Sorted by luminous intensity and wavelength per rank taping
Assembly method	Auto pick & place machine (Auto Mounter)
Soldering methods	Reflow soldering and manual soldering
Taping and reel	4,000pcs per reel in a 8mm width tape. (Standard) Reel diameter: $\phi 180\text{mm}$
ESD	1kV (HBM)

Recommended Applications

Cellular Phone, Electric Household Appliances, OA/FA, Other General Applications

Color and Luminous Intensity

(Ta=25°C)

Part No.	Material	Emitted Color	Lens Color	Dominant Wavelength		Luminous Intensity		
				λd (nm)		Iv (mcd)		
				TYP.	I _F	MIN.	TYP.	I _F
UB1113F	InGaN	Blue	Milky White	470	10	17	34	10
UC1113F	InGaN	Blue Green		508	10	80	160	10
UG1113F	InGaN	Green		530	10	96	160	10
UY1113F	AlGaInP	Yellow		590	20	50	100	20
UR1113F	AlGaInP	Red		630	20	50	100	20

Absolute Maximum Ratings

(Ta=25°C)

Item	Symbol	Absolute Maximum Ratings					Unit
		UB	UC	UG	UY	UR	
Power Dissipation	P_d	78	78	78	87	87	mW
Forward Current	I_F	20	20	20	30	30	mA
Pulse Forward Current ※1	I_{FRM}	48	48	48	100	100	mA
Derating (Ta=25°C or higher)	ΔI_F	0.28	0.28	0.28	0.43	0.43	mA/°C
	ΔI_{FRM}	0.69	0.69	0.69	1	1	mA/°C
Reverse Voltage	V_R	5	5	5	5	5	V
Operating Temperature	T_{opr}	-40~+85					°C
Storage Temperature	T_{stg}	-40~+100					°C

 ※1 I_{FRM} Measurement condition : Pulse Width ≤ 1 ms., Duty $\leq 1/20$. (UY,UR : Duty $\leq 1/10$)

Electro-Optical Characteristics(UB,UC,UG)

(Ta=25°C)

Item	Conditions	Symbol	Characteristics			Unit	
			UB	UC	UG		
Forward Voltage	I _F =10mA	V _F	TYP.	3.4	3.4	3.4	V
			MAX.	3.9	3.9	3.9	
Reverse Current	V _R =5V	I _R	MAX.	100	100	100	μ A
Peak Wavelength	I _F =10mA	λ _p	TYP.	465	502	522	nm
Dominant Wavelength	I _F =10mA	λ _d	TYP.	470	508	530	nm
Spectral Line Half Width	I _F =10mA	Δ λ	TYP.	26	30	35	nm
Half Intensity Angle	I _F =10mA	2θ 1/2	TYP.	145(θ x)	145(θ x)	145(θ x)	deg.
				150(θ y)	150(θ y)	150(θ y)	

Electro-Optical Characteristics(UY,UR)

(Ta=25°C)

Item	Conditions	Symbol	Characteristics		Unit	
			UY	UR		
Forward Voltage	I _F =20mA	V _F	TYP.	2.2	2.2	V
			MAX.	2.8	2.8	
Reverse Current	V _R =5V	I _R	MAX.	100	100	μ A
Peak Wavelength	I _F =20mA	λ _p	TYP.	592	641	nm
Dominant Wavelength	I _F =20mA	λ _d	TYP.	590	630	nm
Spectral Line Half Width	I _F =20mA	Δ λ	TYP.	18	18	nm
Half Intensity Angle	I _F =20mA	2θ 1/2	TYP.	146(θ x)	146(θ x)	deg.
				154(θ y)	154(θ y)	

Luminous Intensity Rank

(Ta=25°C)

Rank	I _v (mcd)									
	UB		UC		UG		UY		UR	
	I _F =10mA		I _F =10mA		I _F =10mA		I _F =20mA		I _F =20mA	
	MIN.	MAX.	MIN.	MAX.	MIN.	MAX.	MIN.	MAX.	MIN.	MAX.
A	/		80	112	/		50	100	50	100
B			96	136			70	140	70	140
C			112	160			96	136	100	200
D	17	24	136	192	112	160	140	280	140	280
E	20	28	160	224	136	192	200	400	200	400
F	24	34	192	320	160	224	280	-	280	-
G	28	40	224	-	192	272	/		/	
H	34	48	/		224	320				
J	40	56			272	-				
K	48	-			/		/			

Please contact our sales staff concerning rank designation.

Color Tone Groups (λd)

(Ta=25°C)

Rank	Dominant Wavelength λd (nm)			
	UY		UR	
	I _F =20mA		I _F =20mA	
	MIN.	MAX.	MIN.	MAX.
A	580	585	620	630
B	584	589	628	638
C	588	593	/	
D	592	597		
E	596	601		

Please contact our sales staff concerning rank designation.

特性グラフ(UB)

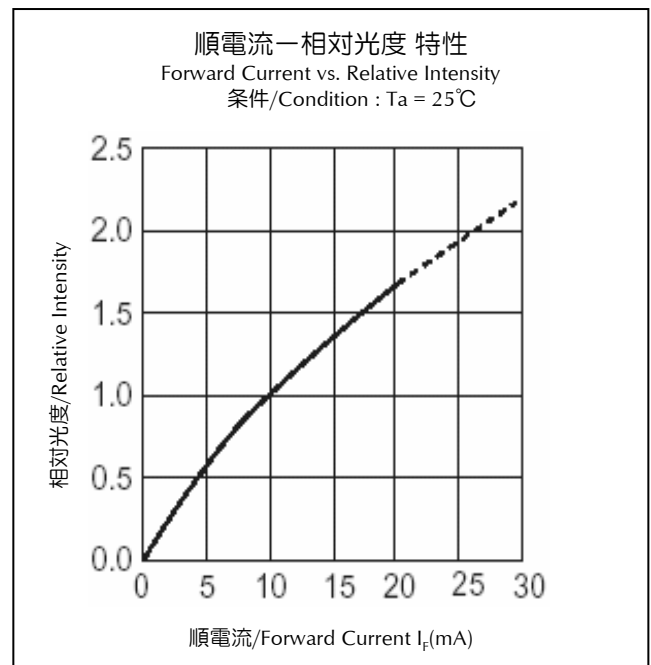
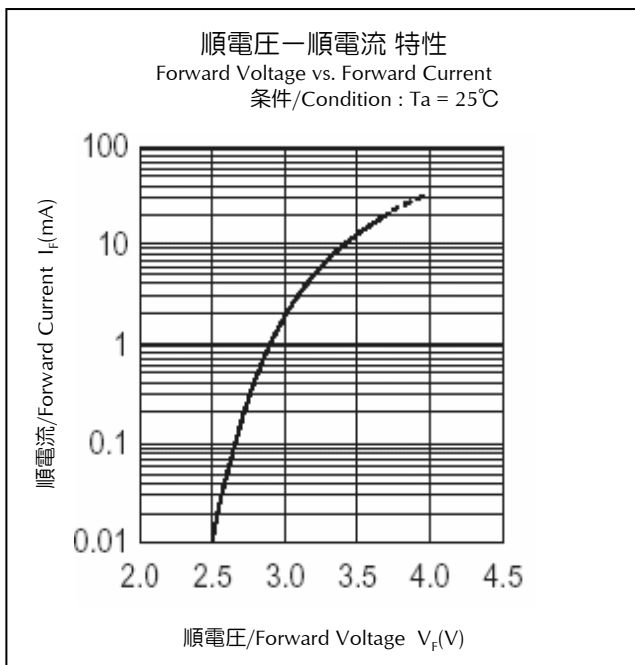
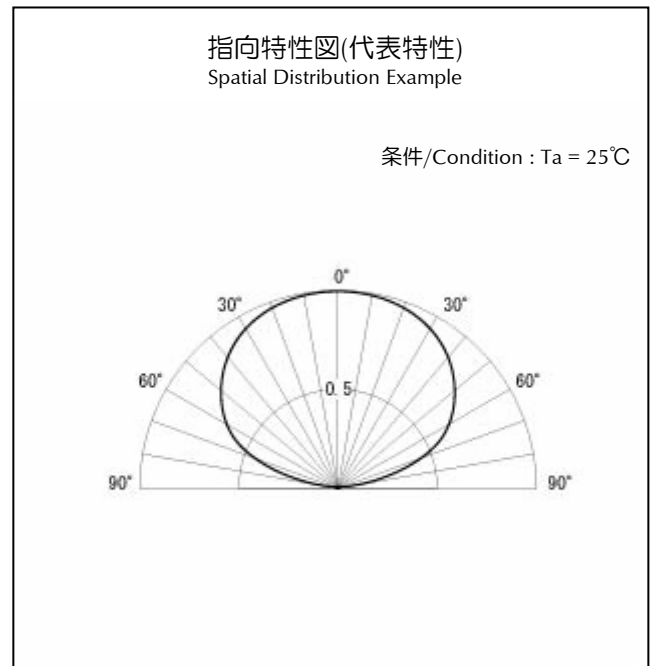
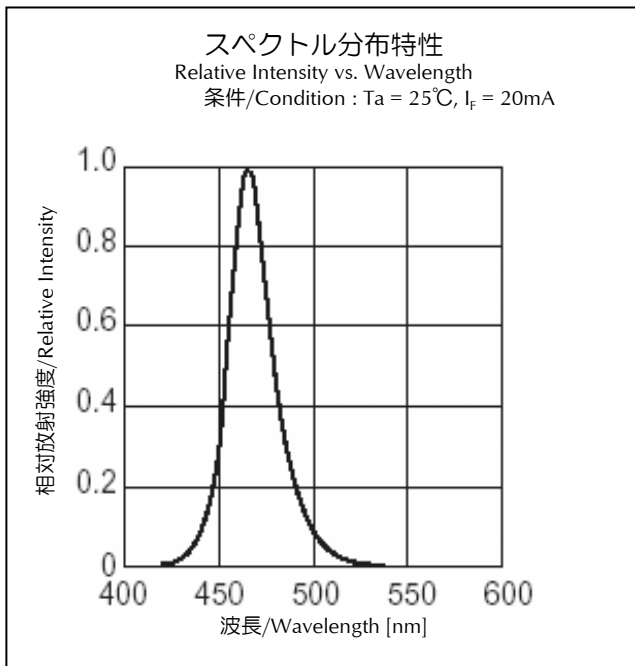

特性グラフ(UB)

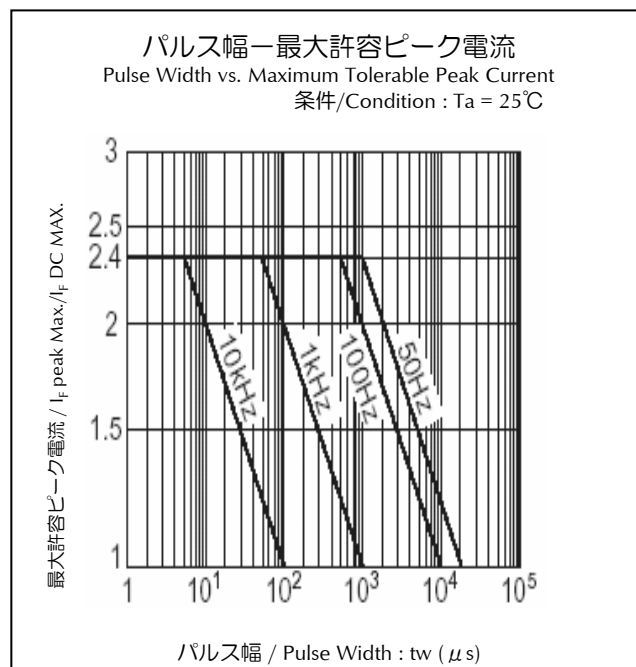
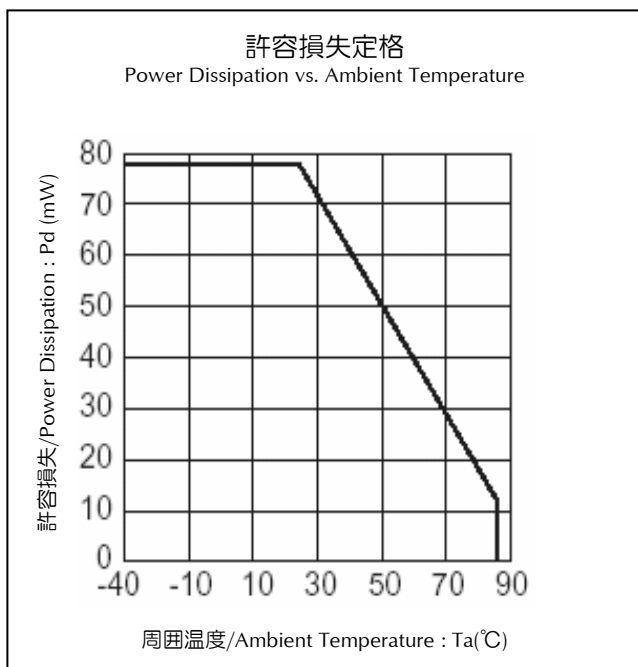
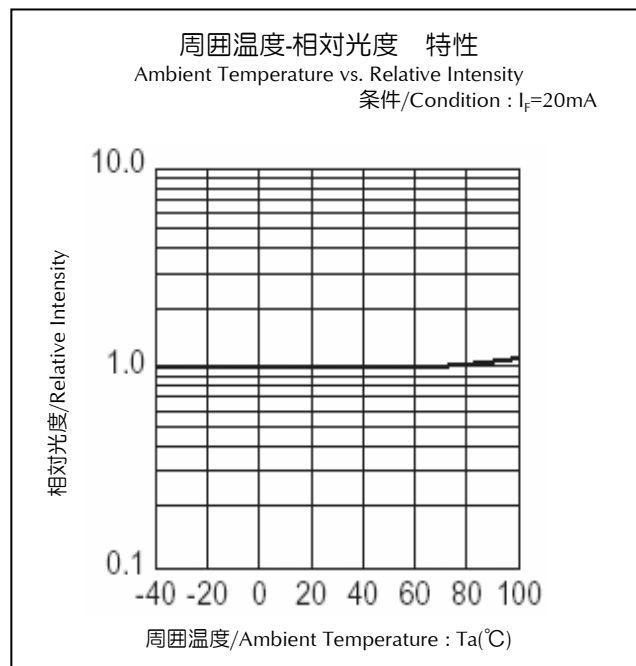
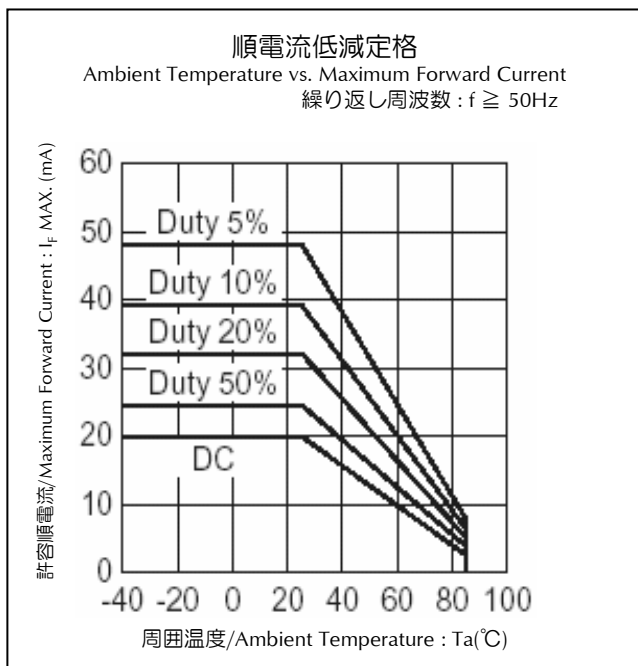

特性グラフ(UC)

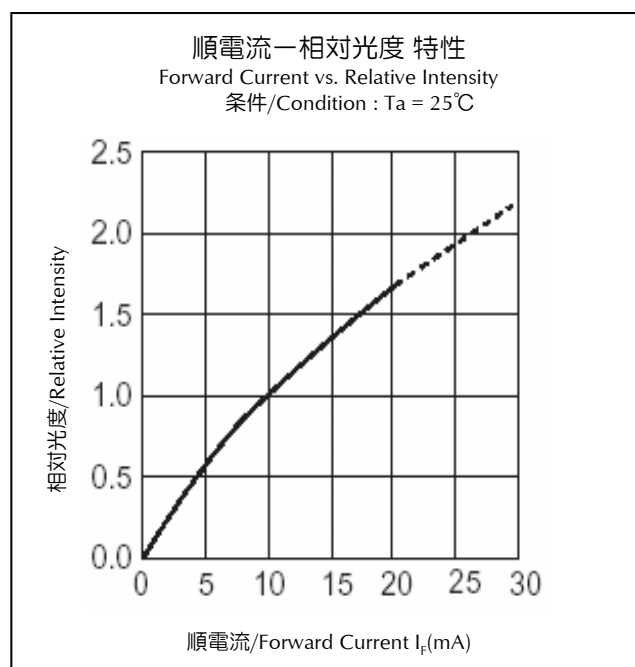
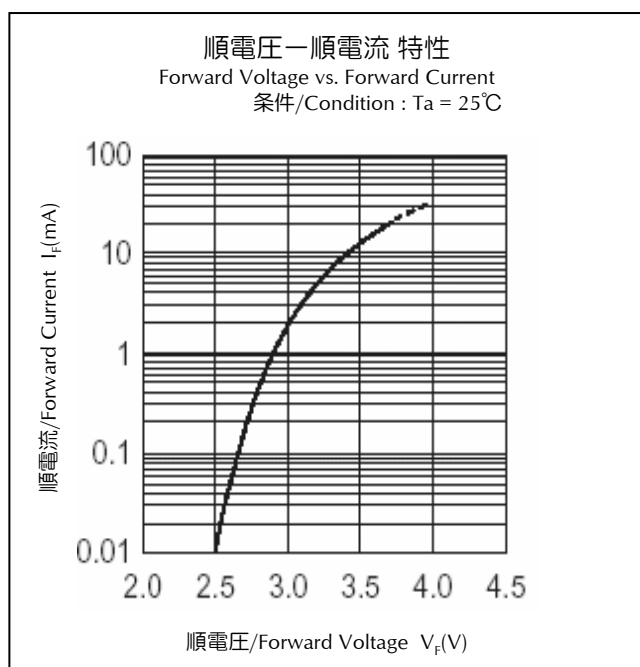
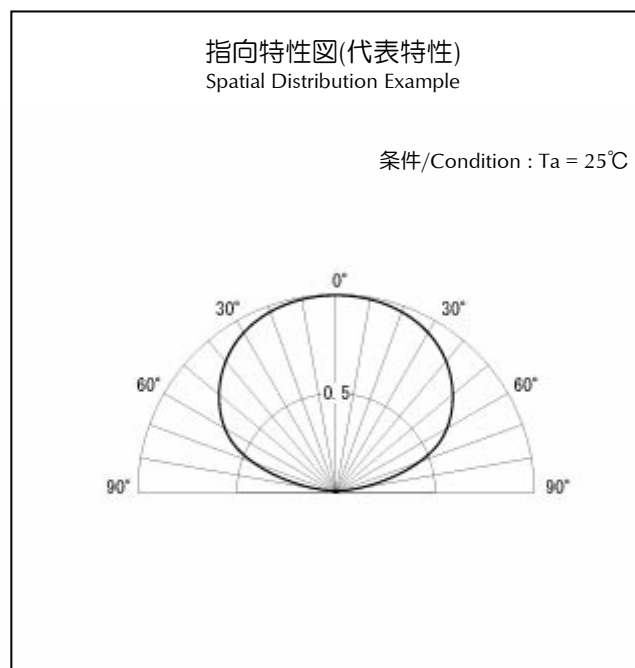
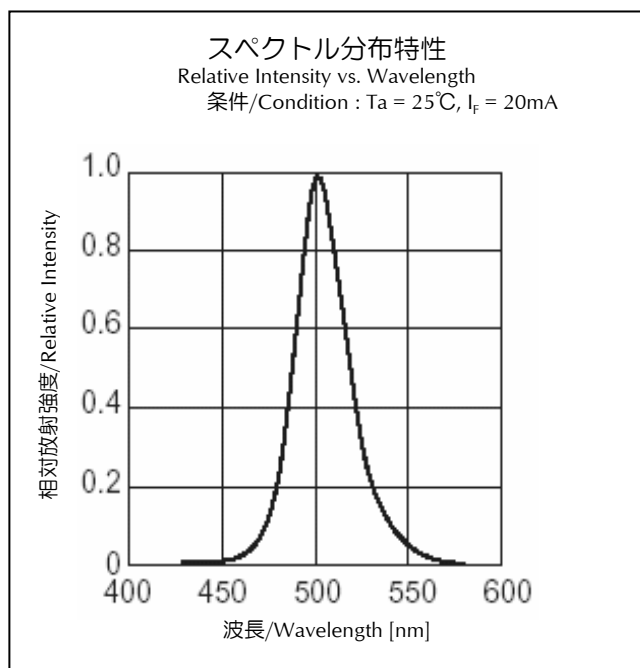

特性グラフ(UC)

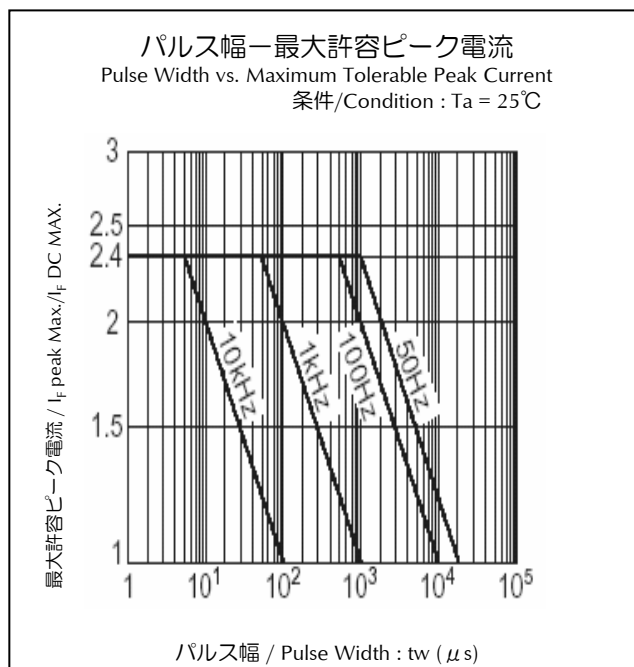
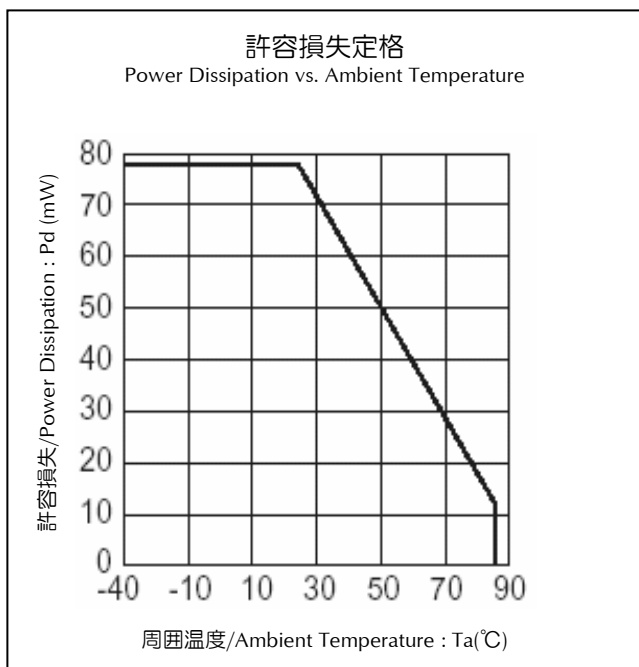
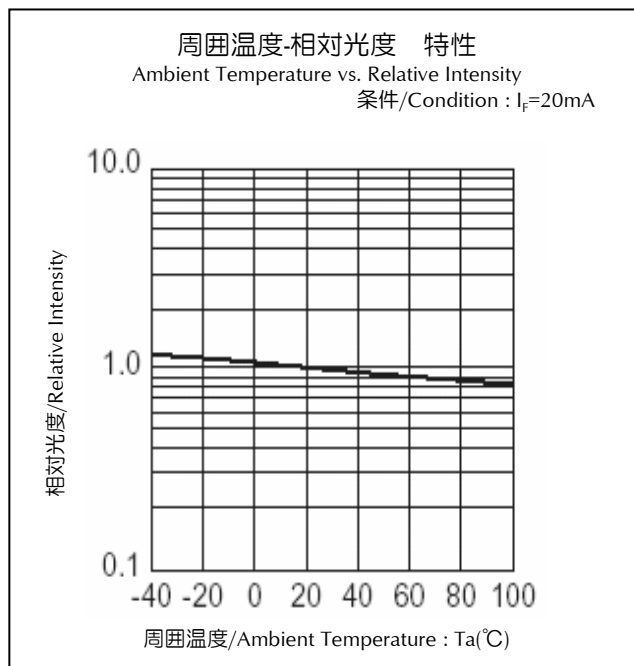
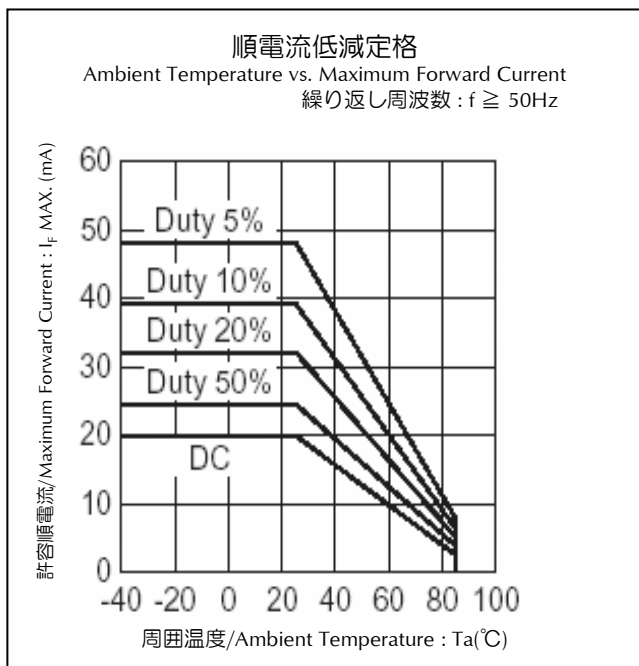

特性グラフ(UG)

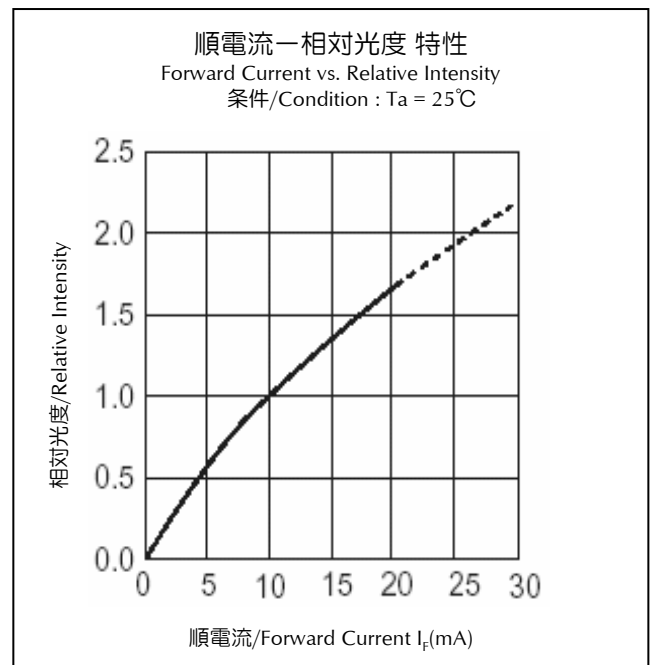
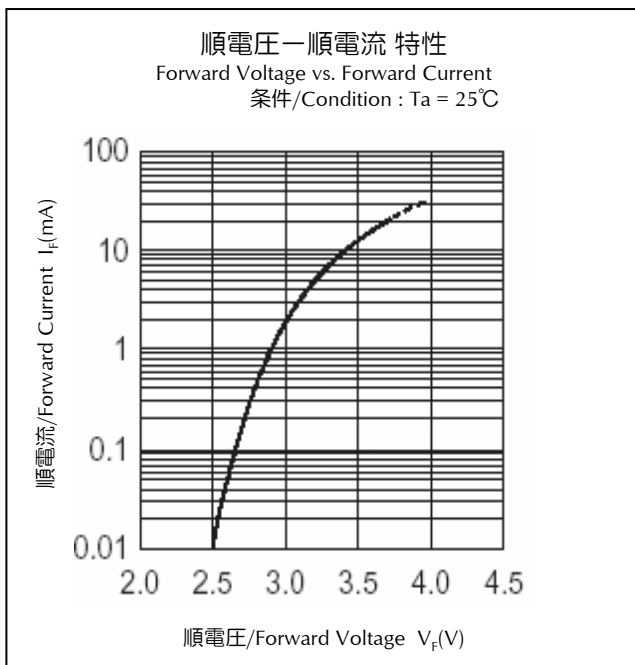
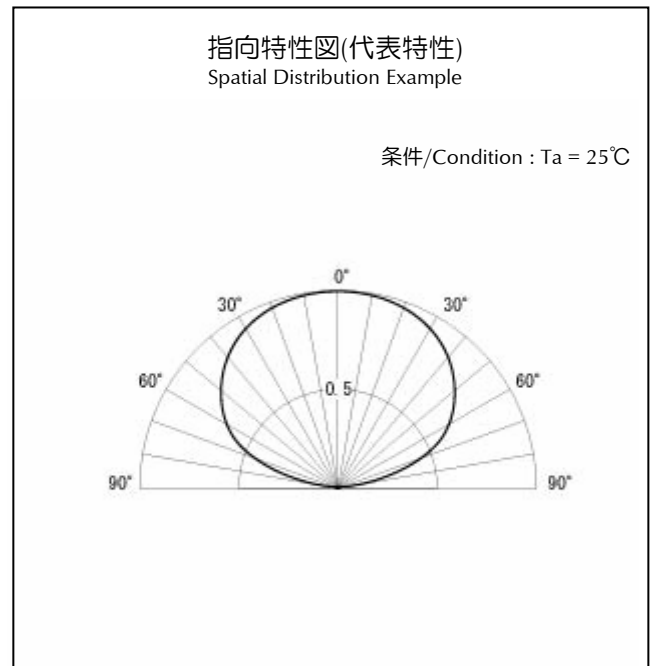
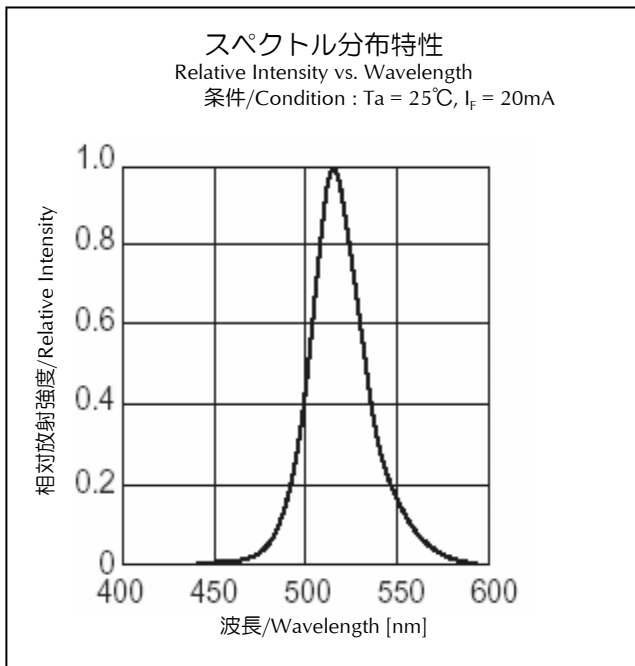

特性グラフ(UG)

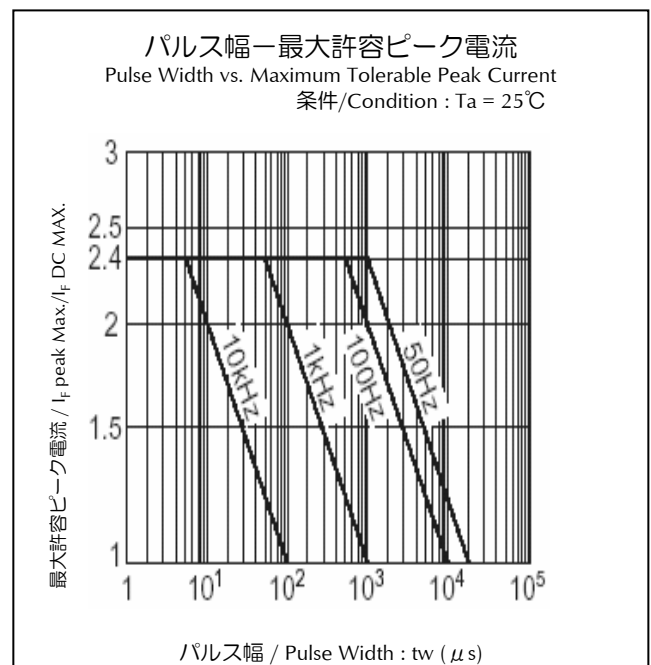
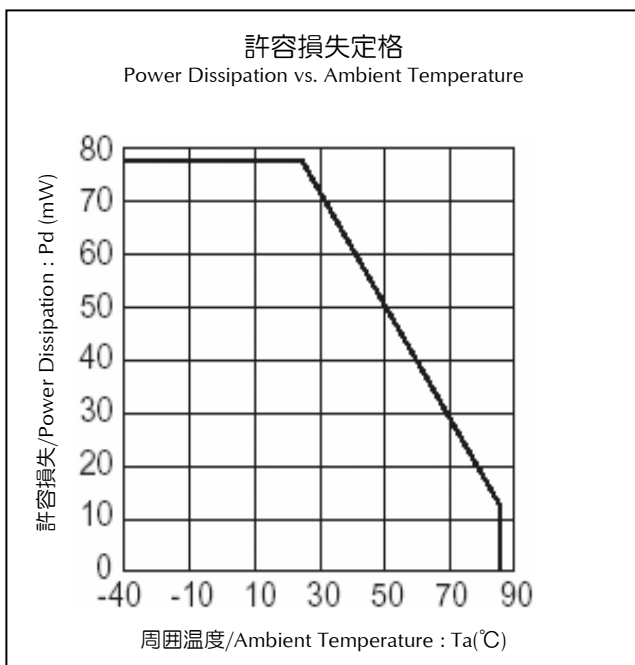
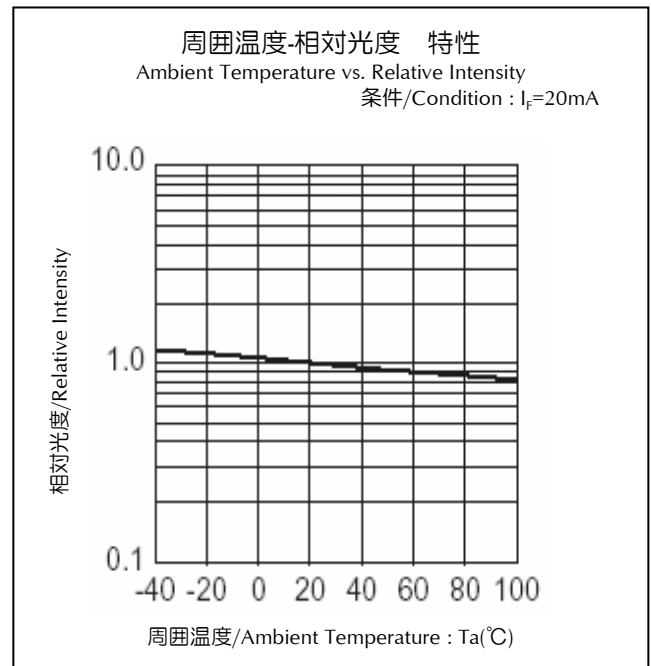
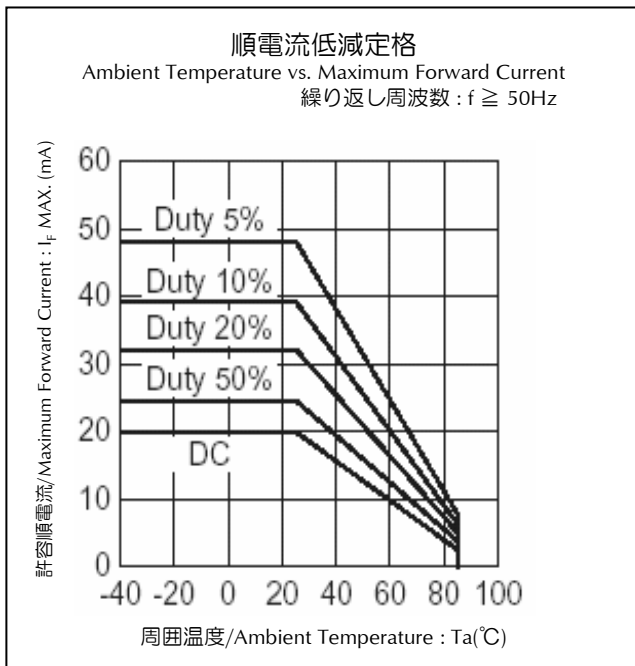

特性グラフ(UY)

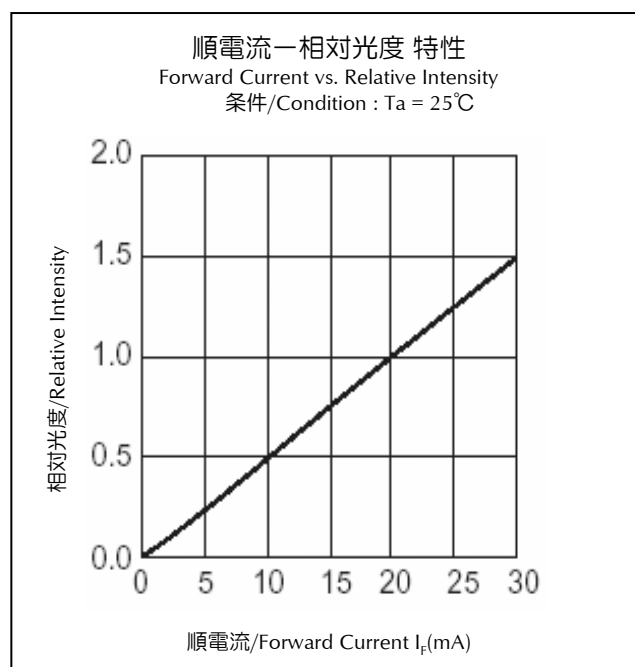
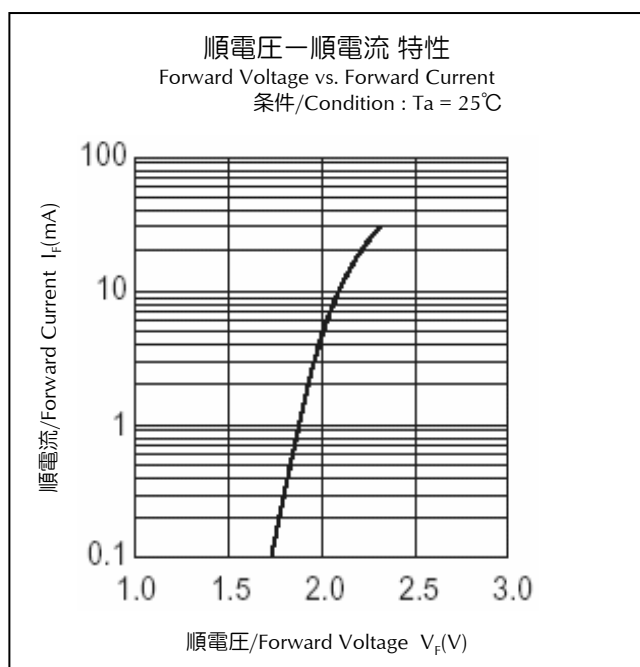
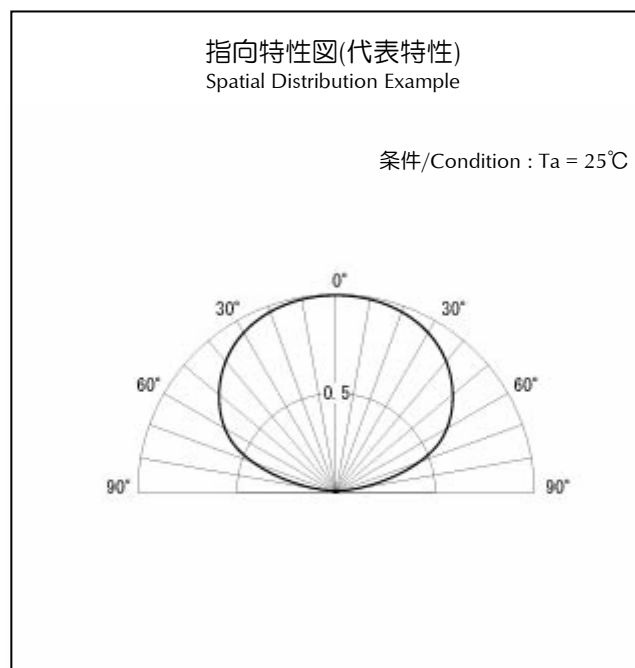
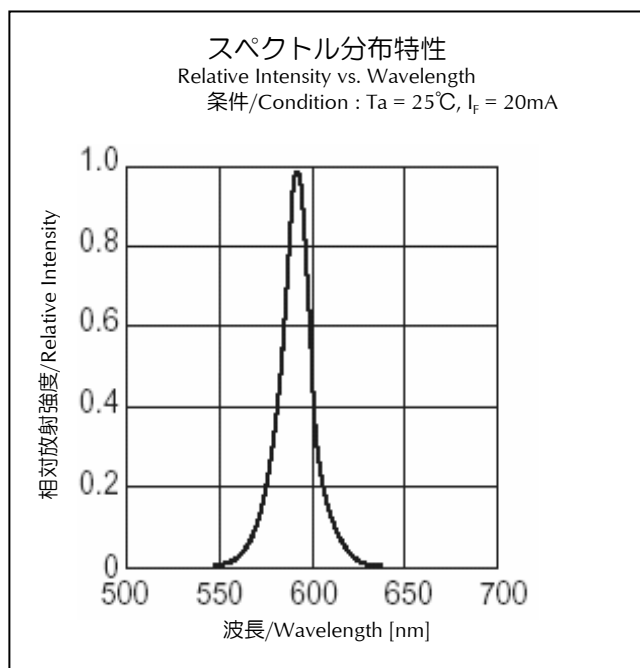

特性グラフ(UY)

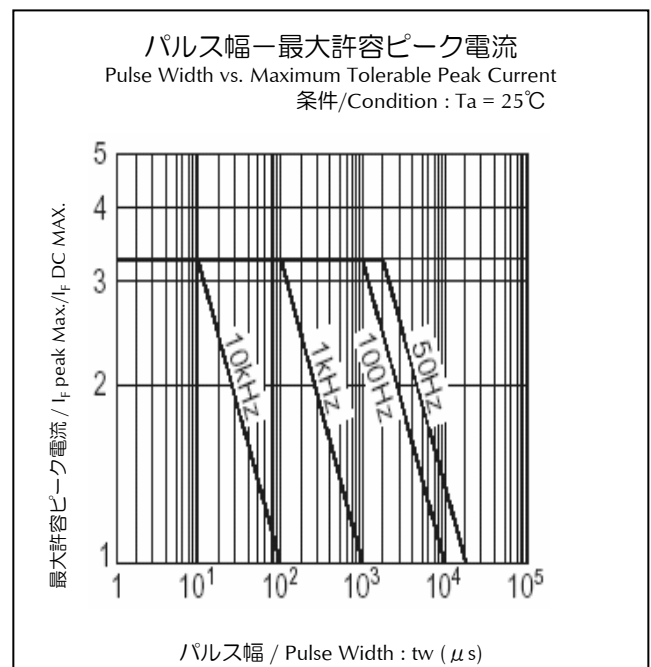
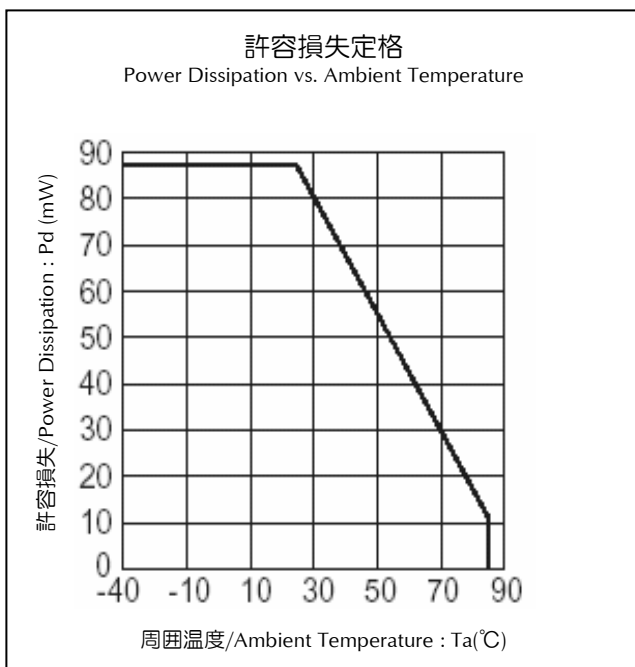
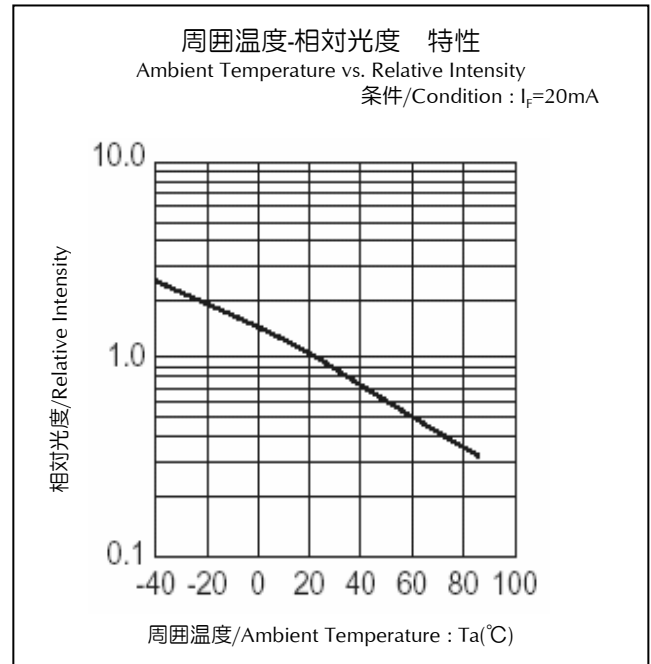
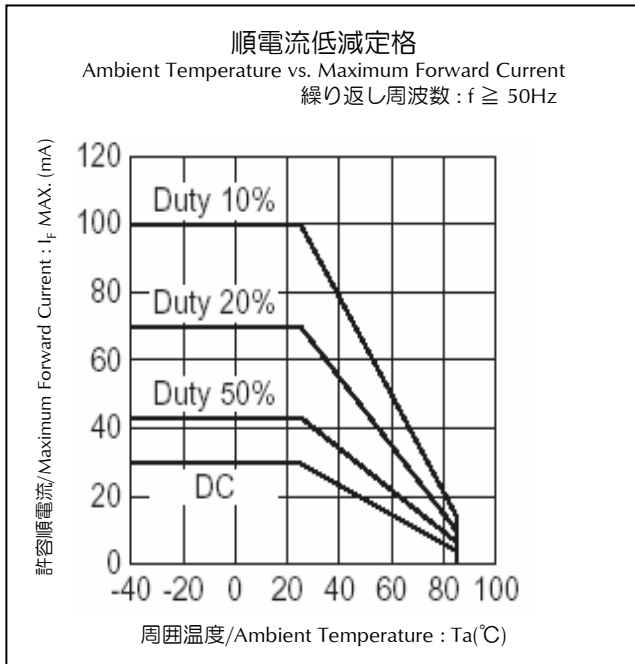

特性グラフ(UR)

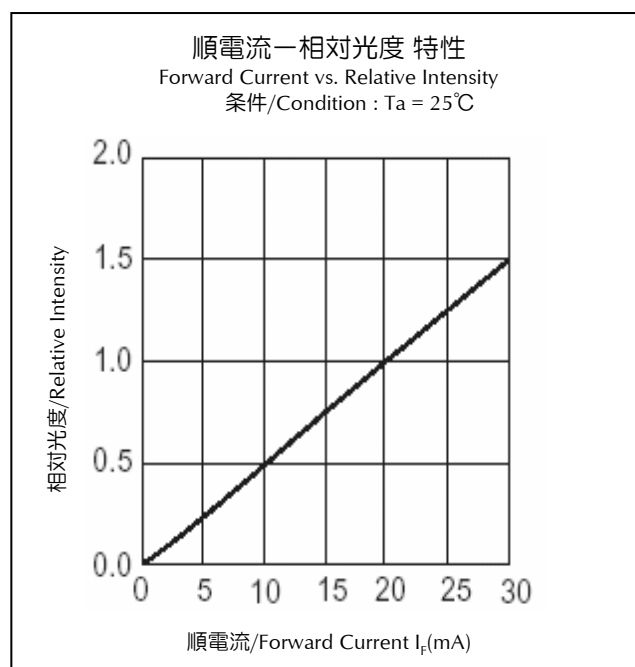
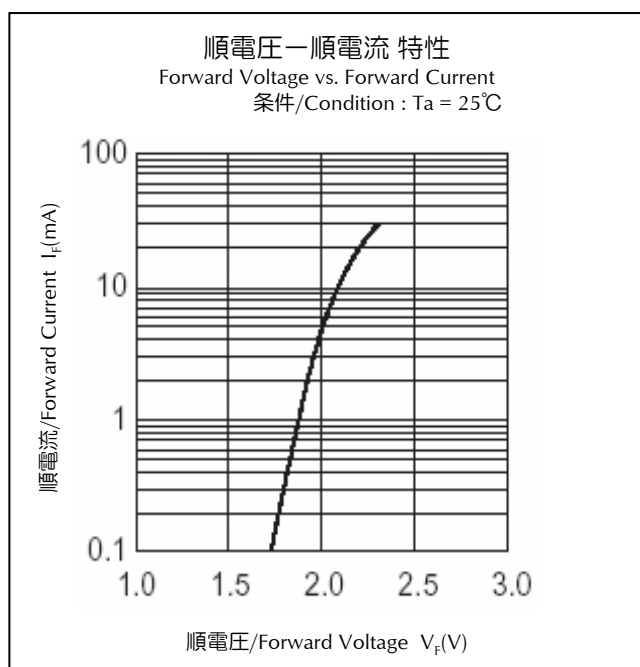
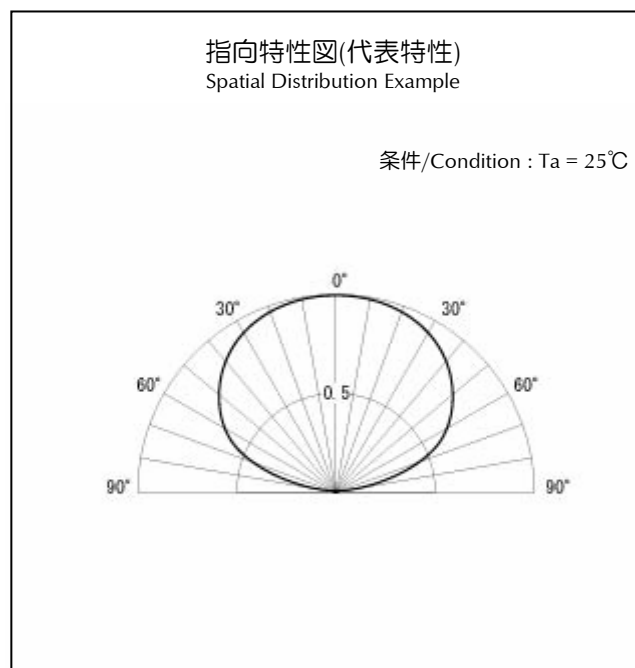
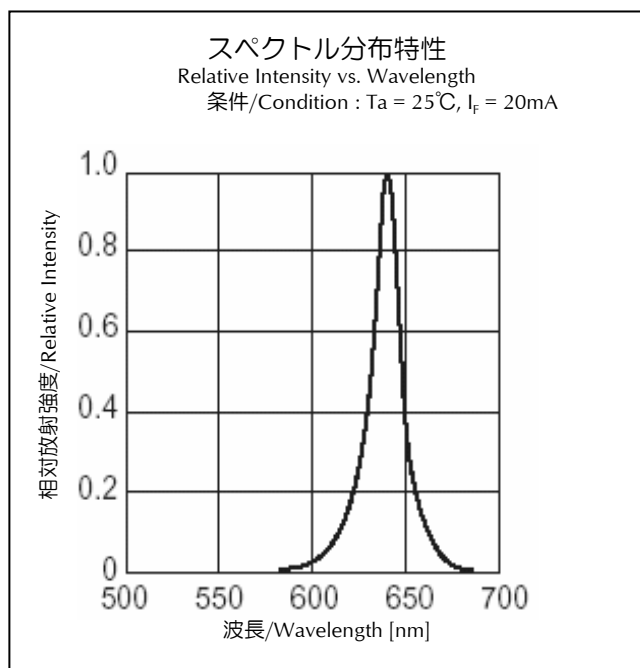

特性グラフ(UR)

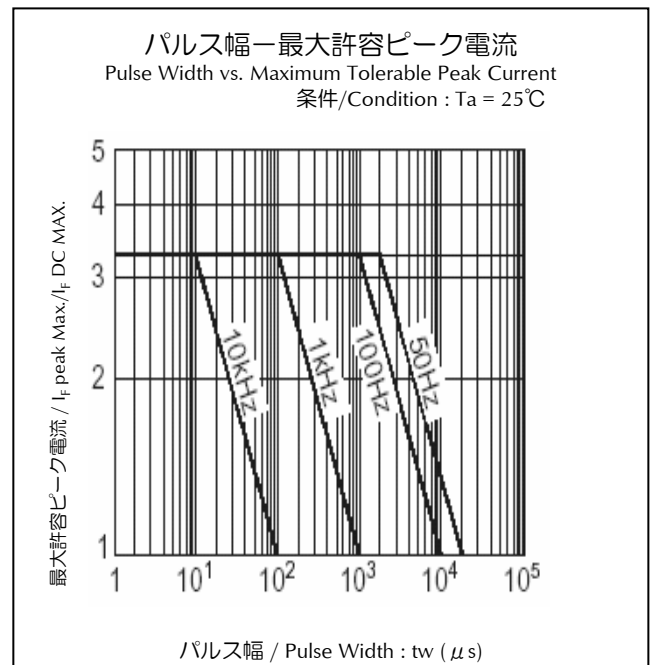
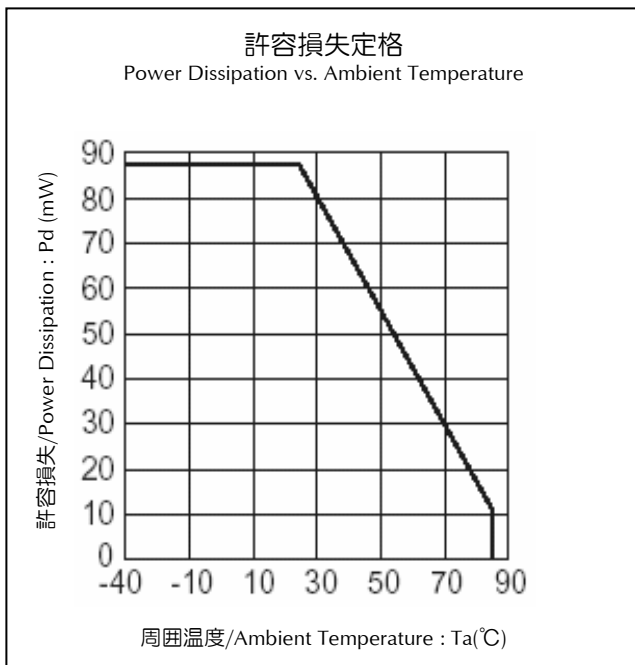
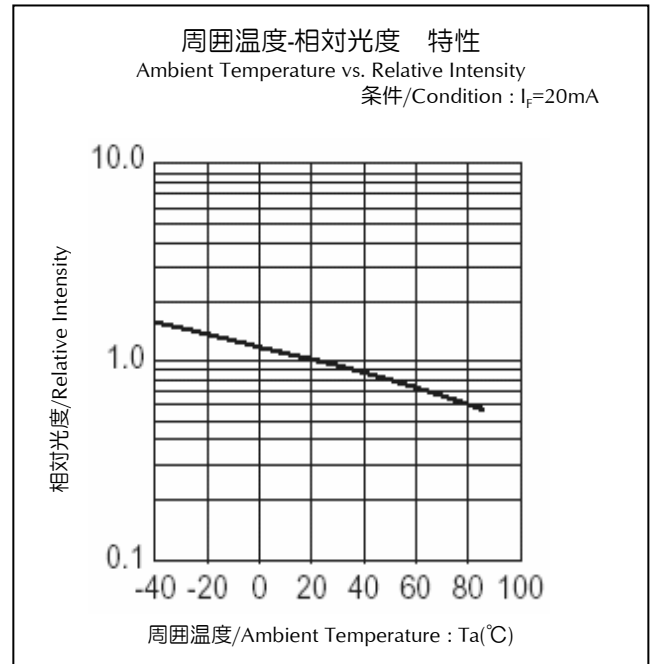
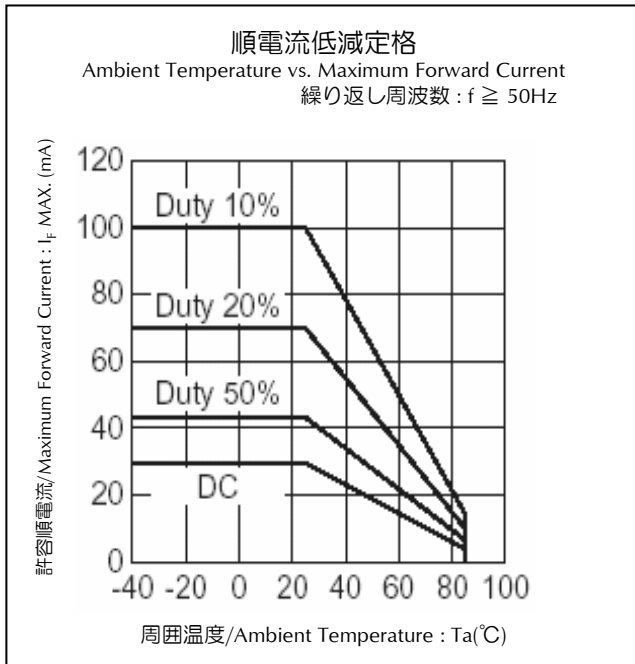

外形寸法

(単位：mm)

重量：(2.20)mg

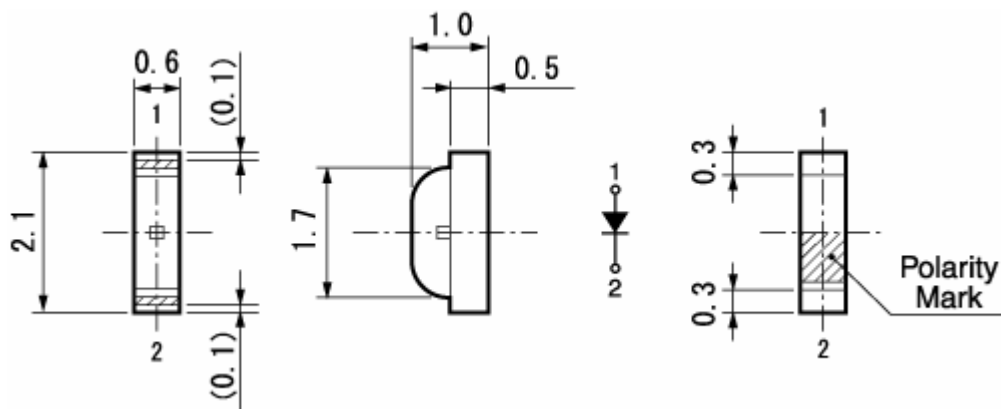

はんだ付け推奨パターン

(単位：mm)

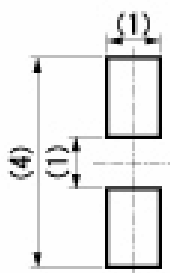

テーピング寸法

(単位：mm)

※梱包数量:4,000個/1リール(標準)

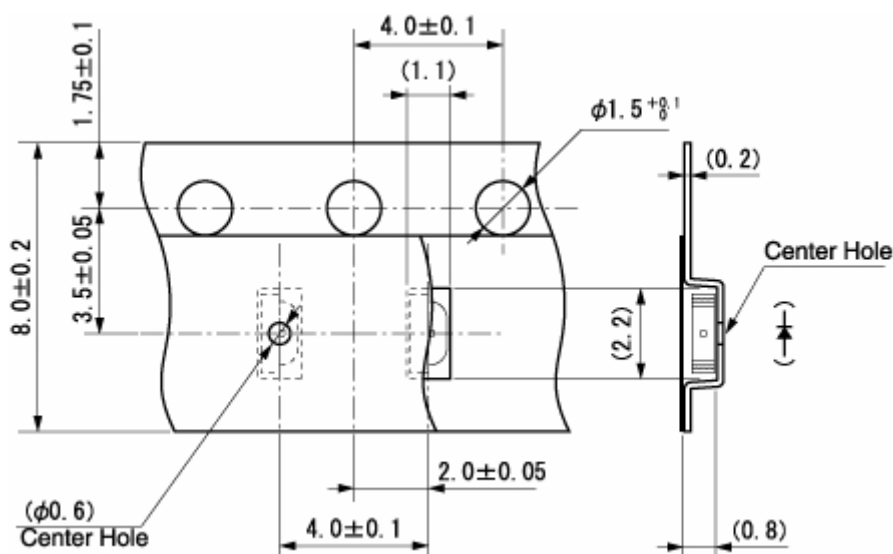

Reflow Soldering Conditions

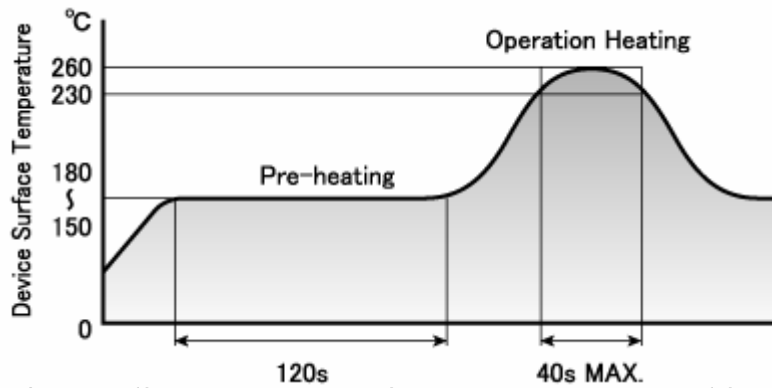

- 1) The above profile temperature gives the maximum temperature of the LED resin surface. Please set the temperature so as to avoid exceeding this range.
- 2) Total times of reflow soldering process shall be no more than 2 times. When the second reflow soldering process is performed, intervals between the first and second reflow should be short as possible (while allowing some time for the component to return to normal temperature after the first reflow) in order to prevent the LED from absorbing moisture.
- 3) Temperature fluctuation to the LED during the pre-heating process shall be minimized. (6°C maximum)

Manual Soldering Conditions

Iron tip temp.	350 °C	(MAX.)
Soldering time and frequency	3 s	(MAX.)
	1 time	(MAX.)

Reliability Testing Result

Reliability Testing Result	Applicable Standard	Testing Conditions	Duration	Failure
Room Temp. Operating Life	EIAJ ED-4701/100(101)	Ta = 25°C, If = Maximum Rated Current	1,000 h	0/25
Resistance to Soldering Heat	EIAJ ED-4701/300(301)	Pre-heating : 150~180°C 120s Max. Operation Heating : 230°C 40s Max. Peak Temperature : 260°C	Twice	0/25
Temperature Cycling	EIAJ ED-4701/100(105)	Minimum Rated Storage Temperature(30min) ~Normal Temperature(15min) ~Maximum Rated Storage Temperature(30min) ~Normal Temperature(15min)	5 cycles	0/25
Wet High Temp. Storage Life	EIAJ ED-4701/100(103)	Ta = 60±2°C, RH = 90±5%	1,000 h	0/25
High Temp. Storage Life	EIAJ ED-4701/200(201)	Ta = Maximum Rated Storage Temperature	1,000 h	0/25
Low Temp. Storage Life	EIAJ ED-4701/200(202)	Ta = Minimum Rated Storage Temperature	1,000 h	0/25
Vibration, Variable Frequency	EIAJ ED-4701/400(403)	98.1m/s ² (10G), 100 ~ 2KHz sweep for 20min., XYZ each direction	2 h	0/10

Failure Criteria

Items	Symbols	Conditions	Failure criteria
Luminous Intensity	Iv	If Value of each product Luminous Intensity	Testing Min. Value < Spec. Min. Value x 0.5
Forward Voltage	V _F	If Value of each product Forward Voltage	Testing Max. Value ≥ Spec. Max. Value x 1.2
Reverse Current	I _R	V _R = Maximum Rated Reverse Voltage V	Testing Max. Value ≥ Spec. Max. Value x 2.5
Cosmetic Appearance	-	-	Occurrence of notable decoloration, deformation and cracking

Special Notice to Customers Using the Products and Technical Information Shown in This Data Sheet

- 1) The technical information shown in the data sheets are limited to the typical characteristics and circuit examples of the referenced products. It does not constitute the warranting of industrial property nor the granting of any license.
- 2) For the purpose of product improvement, the specifications, characteristics and technical data described in the data sheets are subject to change without prior notice. Therefore it is recommended that the most updated specifications be used in your design.
- 3) When using the products described in the data sheets, please adhere to the maximum ratings for operating voltage, heat dissipation characteristics, and other precautions for use. We are not responsible for any damage which may occur if these specifications are exceeded.
- 4) The products that have been described to this catalog are manufactured so that they will be used for the electrical instrument of the benchmark (OA equipment, telecommunications equipment, AV machine, home appliance and measuring instrument).
The application of aircrafts, space borne application, transportation equipment, medical equipment and nuclear power control equipment, etc. needs a high reliability and safety, and the breakdown and the wrong operation might influence the life or the human body. Please consult us beforehand if you plan to use our product for the usages of aircrafts, space borne application, transportation equipment, medical equipment and nuclear power control equipment, etc. except OA equipment, telecommunications equipment, AV machine, home appliance and measuring instrument.
- 5) In order to export the products or technologies described in this data sheet which are under the "Foreign Exchange and Foreign Trade Control Law," it is necessary to first obtain an export permit from the Japanese government.
- 6) No part of this data sheet may be reprinted or reproduced without prior written permission from Stanley Electric Co., Ltd.
- 7) The most updated edition of this data sheet can be obtained from the address below:
<http://www.stanley-components.com>