



**Pb-free
HEAT**

STANLEY

URGB1308B

PLCC-6 Type Tri-color

Features

Package	PLCC-6 Type, Water Clear Resin
Product features	<ul style="list-style-type: none"> • Outer Dimension 3.0 x 3.5 x 1.9 mm(L x W x H) • Temperature range. Storage Temperature : -40 °C ~100 °C Operating Temperature : -40 °C ~85 °C • No lead package and lead-free soldering compatible • RoHS compliant
Dominant wavelength	Blue : 470nm (UB) Green : 530nm (UG) Red : 630nm (UR)
Spatial distribution	120 deg.
Die materials	UB,UG : InGaN, UR :AlGaInP
Rank grouping parameter	Sorted by luminous intensity and wavelength per rank taping
Assembly method	Auto pick & place machine (Auto Mounter)
Soldering methods	Reflow soldering and manual soldering
Taping and reel	2,000pcs per reel in a 8mm width tape. (Standard) Reel diameter: Φ 180mm
ESD	1kV (HBM)

Recommended Applications

Amusement Equipment, OA/FA, Other General Applications

Color Variations and Luminous Intensity

(T_a=25°C)

Part No.	Die Name	Material	Emitted Color	Lens Color	Dominant Wavelength λ_d (nm)		Luminous Intensity I_v (mcd)		
					TYP.	I _F	MIN.	TYP.	I _F
					URGB1308B	UB	InGaN	Blue	Water Clear
UG	InGaN	Green	530	20		200	500	20	
UR	AlGaInP	Red	630	20		140	350	20	

※ Note : The luminous intensity(I_v) and dominant wavelength(λ_d) above are the setup values of the sorting machine.
 (Tolerance : I_v ... $\pm 15\%$, λ_d ... $\pm 2\text{nm}$)

Absolute Maximum Ratings

(T_a=25°C)

Item	Symbol	Absolute Maximum Ratings			Unit
		UB	UG	UR	
Power Dissipation	P _d	84	84	87	mW
Forward Current	I _F	20	20	30	mA
Pulse Forward Current ^{※1}	I _{FRM}	100	100	100	mA
Derating (T _a =60°C or higher)	ΔI _F	0.50	0.50	0.75	mA/°C
	ΔI _{FRM}	2.50	2.50	2.50	mA/°C
Reverse Voltage	V _R	5	5	5	V
Operating Temperature	T _{opr}	-40~+85			°C
Storage Temperature	T _{stg}	-40~+100			°C

※1 I_{FRM} Measurement condition : Pulse Width ≤ 1ms., Duty ≤ 1/20.

※ The ratings specified above is under the condition that only one diode is lit.

50% Max. of each rating shall be applied when two diodes are lit simultaneously.

30% Max. of each rating shall be applied when all three diodes are lit simultaneously.

Electro-Optical Characteristics (UB,UG,UR)
(T=25°C)

Item	Conditions	Symbol	Characteristics			Unit	
			UB	UG	UR		
Forward Voltage	I _F =20mA	V _F	TYP.	3.7	3.7	2.2	V
			MAX.	4.2	4.2	2.8	
Reverse Current	V _R =5V	I _R	MAX.	100	100	100	μA
Peak Wavelength	I _F =20mA	λ _p	TYP.	465	522	641	nm
Dominant Wavelength	I _F =20mA	λ _d	TYP.	470	530	630	nm
Spectral Line Half Width	I _F =20mA	Δλ	TYP.	26	35	18	nm
Half Intensity Angle	I _F =20mA	2θ _{1/2}	TYP.	120	120	120	deg.

※Note: The dominant wavelength (λ_d) above is the setup value of the sorting machine.
(Tolerance: λ_d ...± 2nm)

Luminous Intensity Rank

(T_a=25°C)

Intensity Tolerance each Rank : +/- 15%

Rank	I _v (mcd)					
	UB		UG		UR	
	I _F =20mA					
	MIN.	MAX.	MIN.	MAX.	MIN.	MAX.
A	50	100	200	400	140	350
B	100	200				
C	200					
D	50	100	400	800		
E	100	200				
F	200					
G	50	100	800			
H	100	200				
J	200					
K	50	100	200	400	350	
L	100	200				
M	200					
N	50	100	400	800		
P	100	200				
Q	200					
R	50	100	800			
S	100	200				
T	200					



Pb-free
HEAT

URGB1308B

PLCC-6 Type Tri-color

Color Tone Groups (λd)

($T=25^{\circ}\text{C}$)

Tolerance: +/- 2nm

Rank	Dominant Wave Length λd (nm)					
	UB		UG		UR	
	$I_f=20\text{mA}$					
	MIN.	MAX.	MIN.	MAX.	MIN.	MAX.
A	460	480	515	540	618	638

Technical Data(UB)

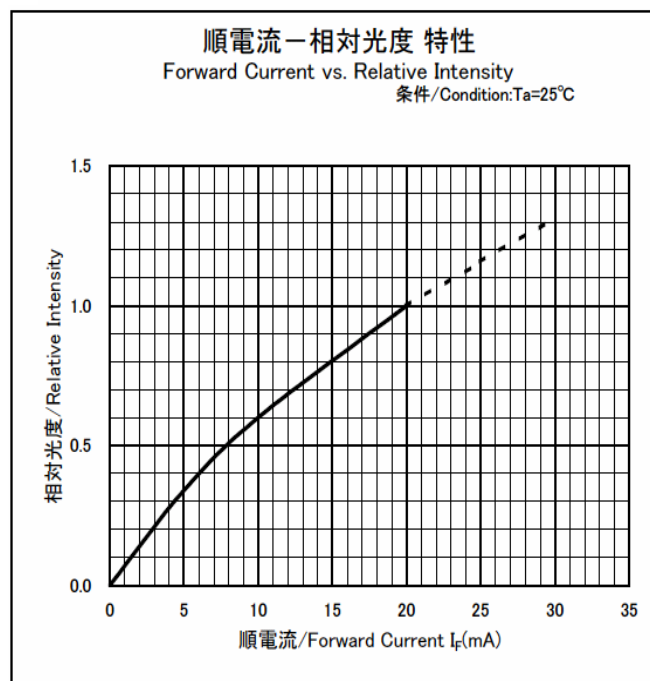
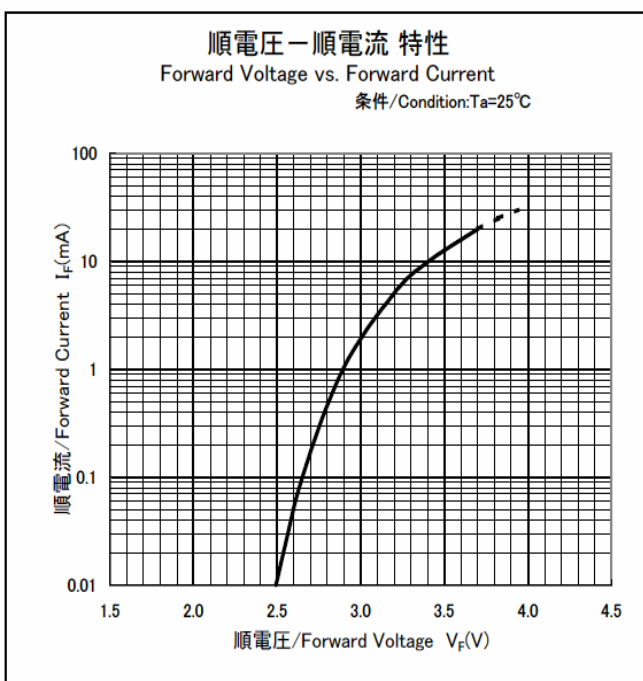
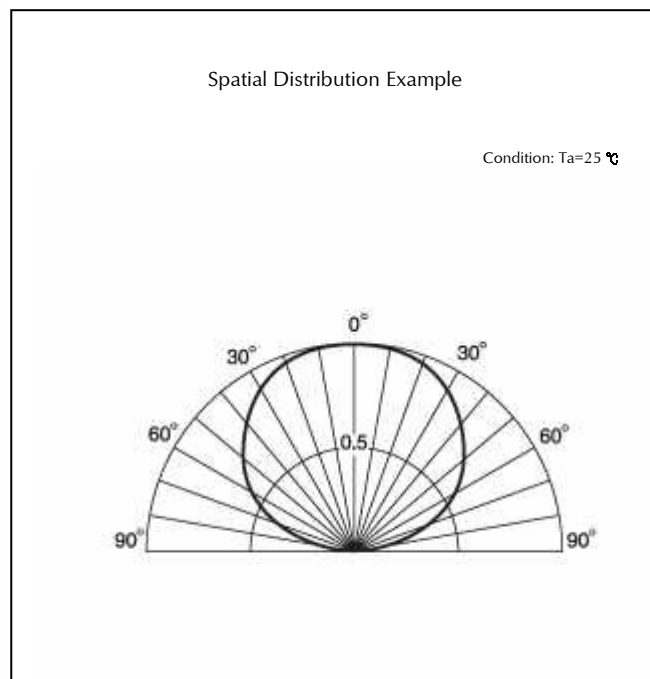
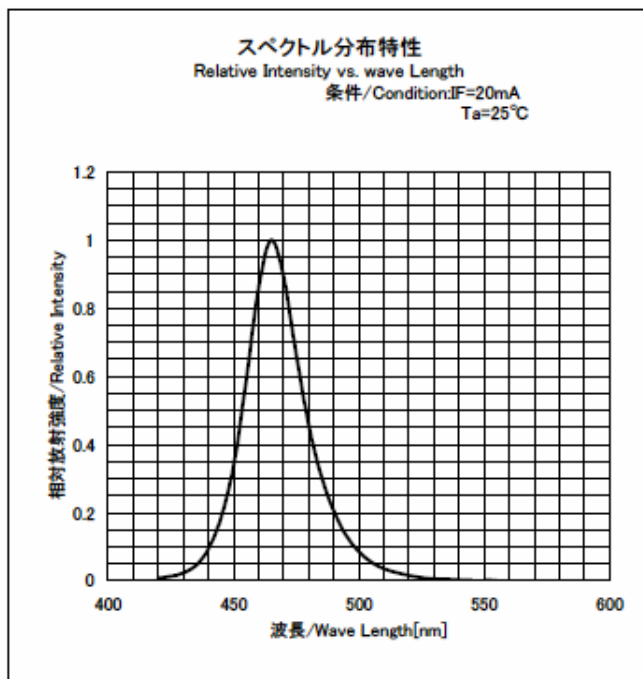

Technical Data(UB)

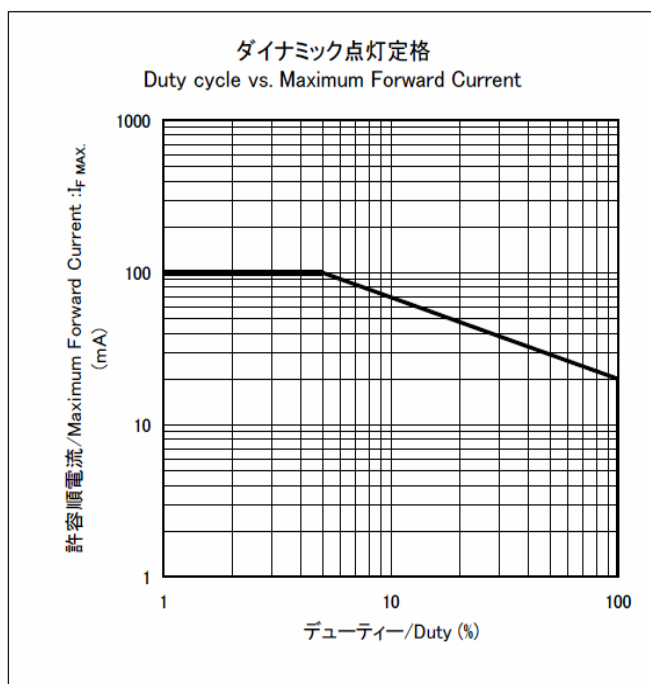
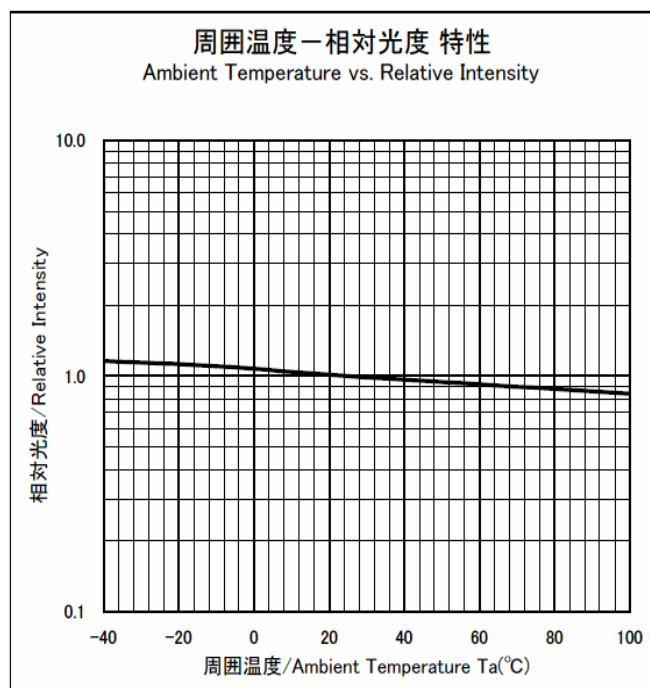
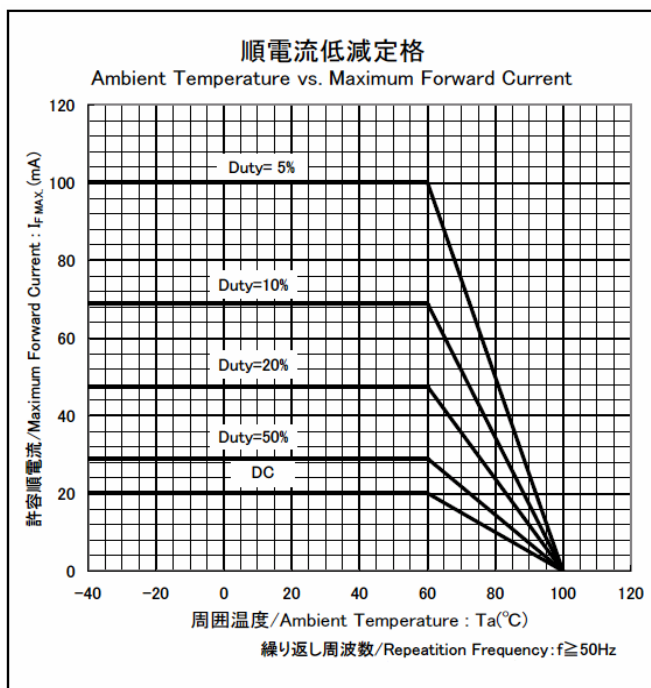

Technical Data(UG)

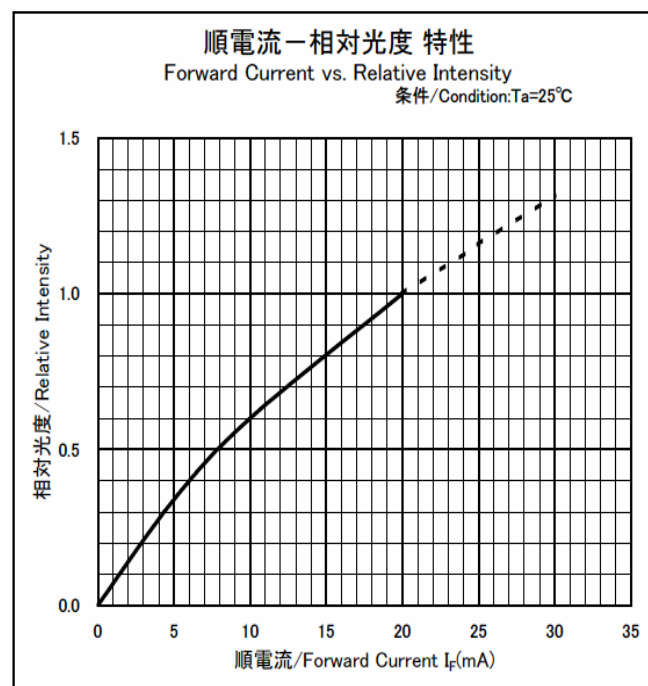
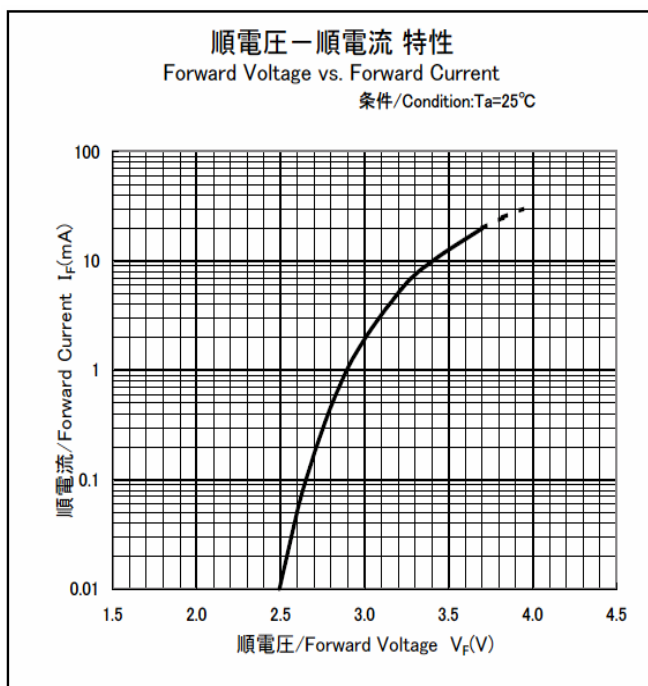
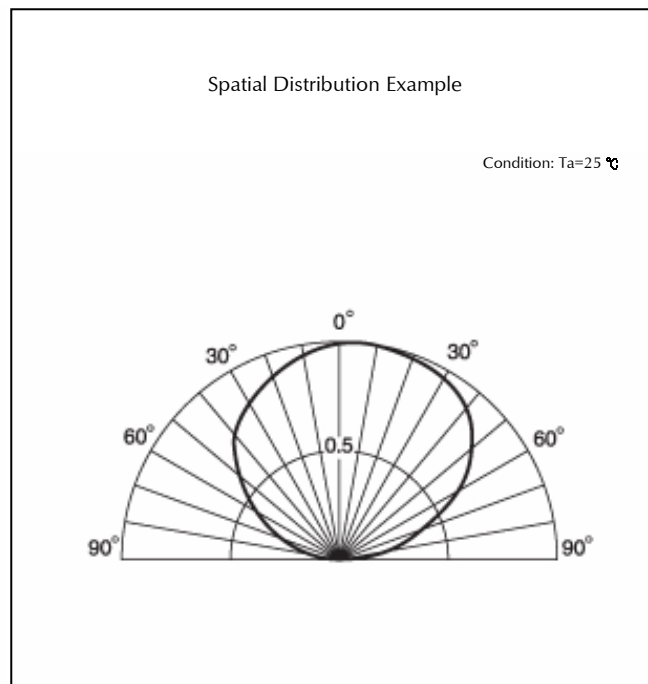
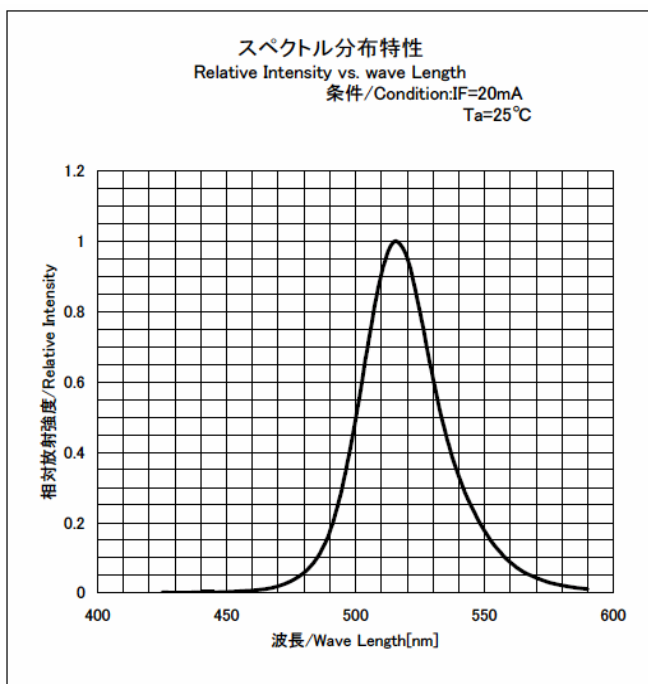

Technical Data(UG)

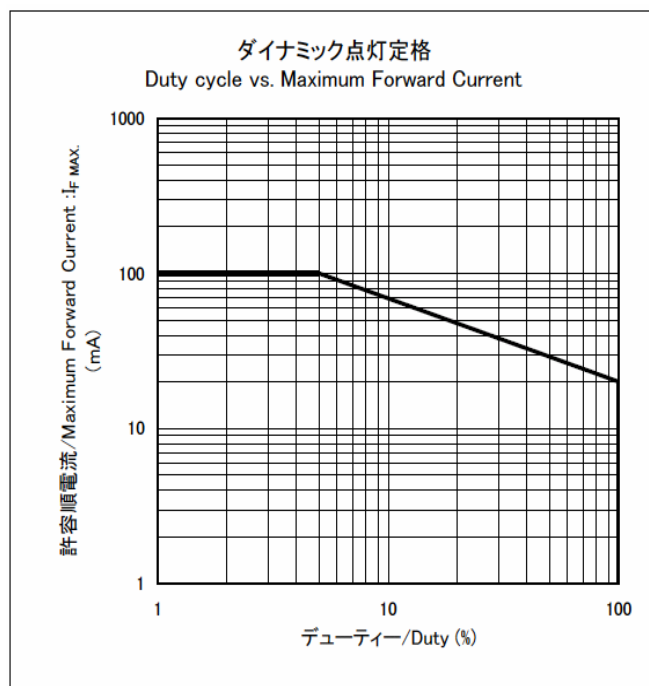
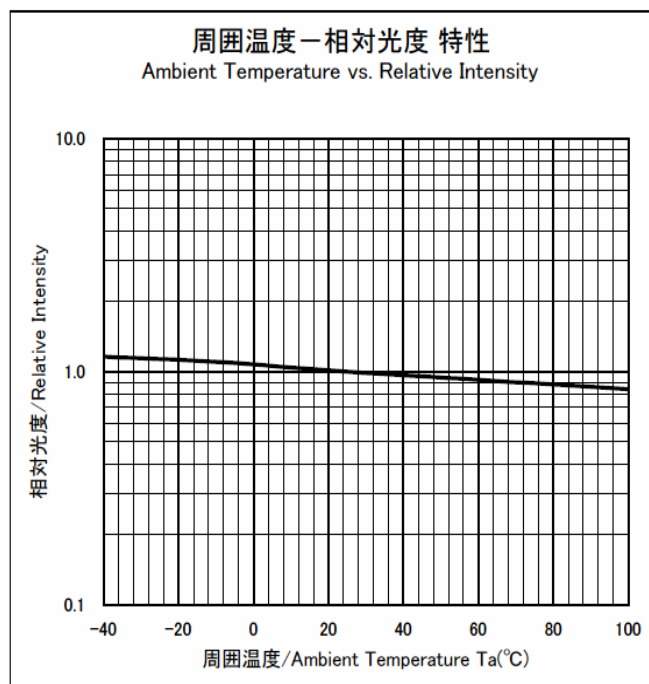
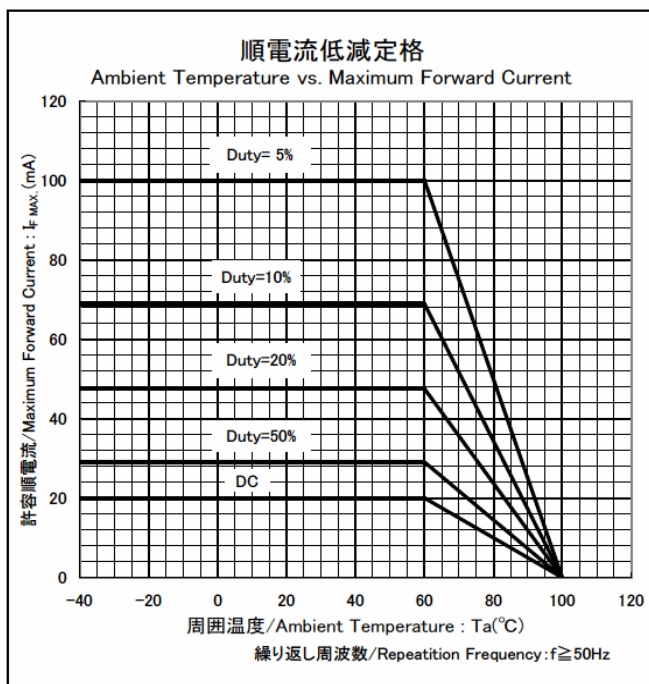

Technical Data(UR)

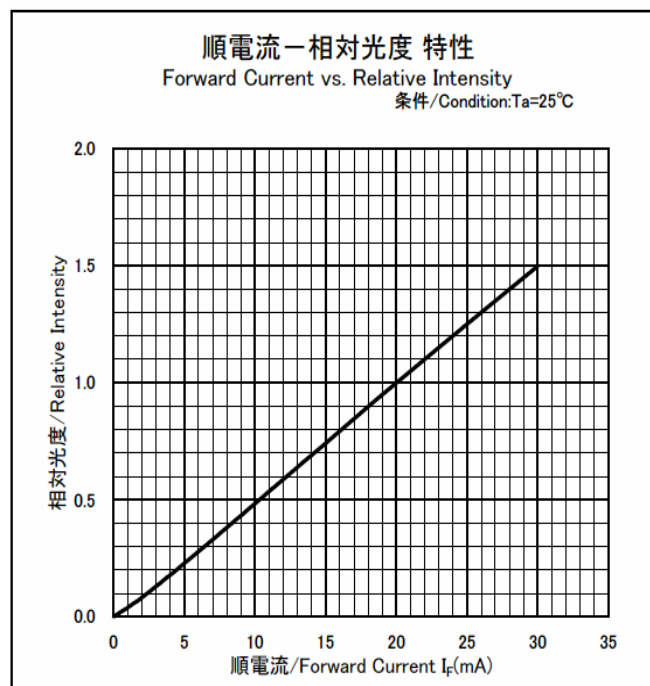
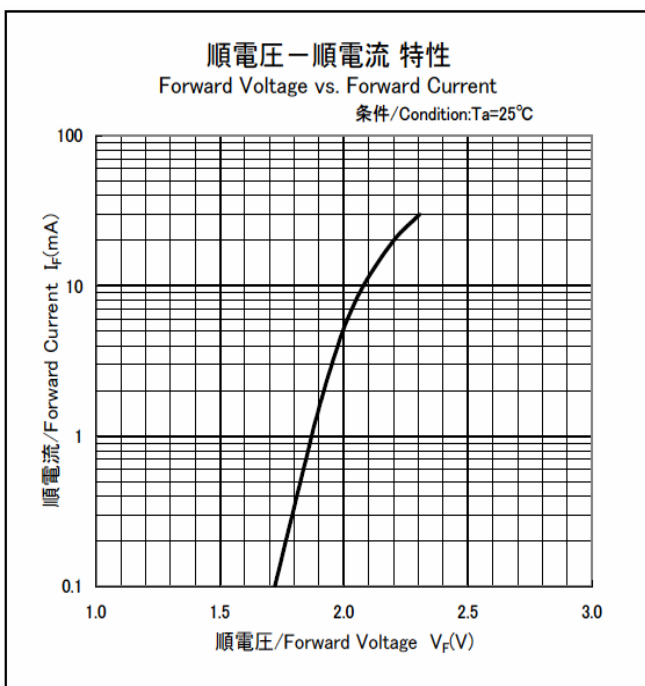
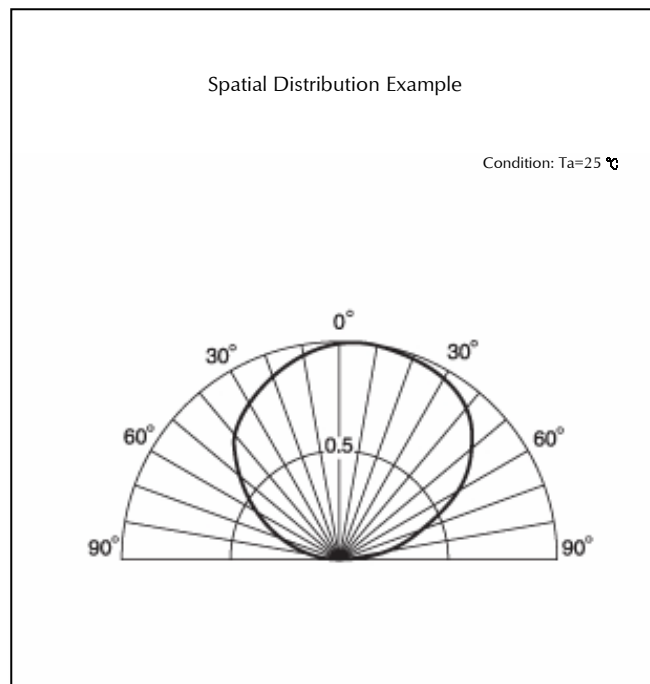
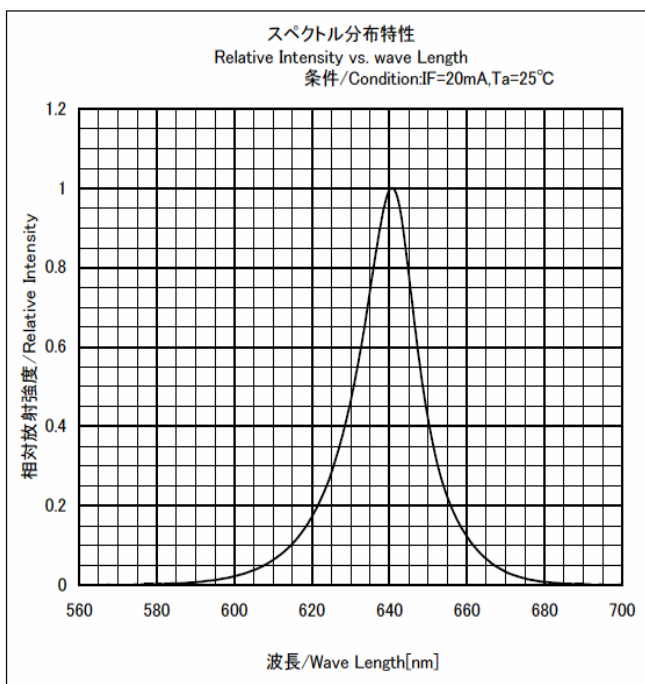

Technical Data(UR)

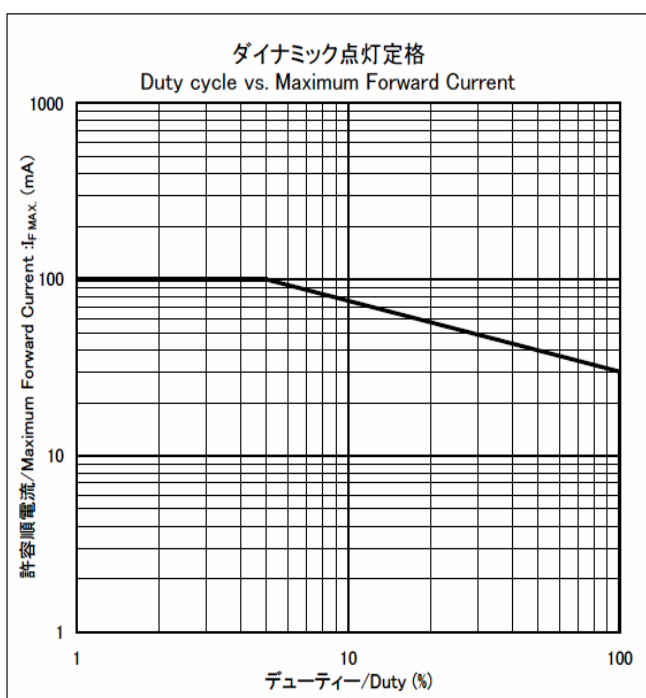
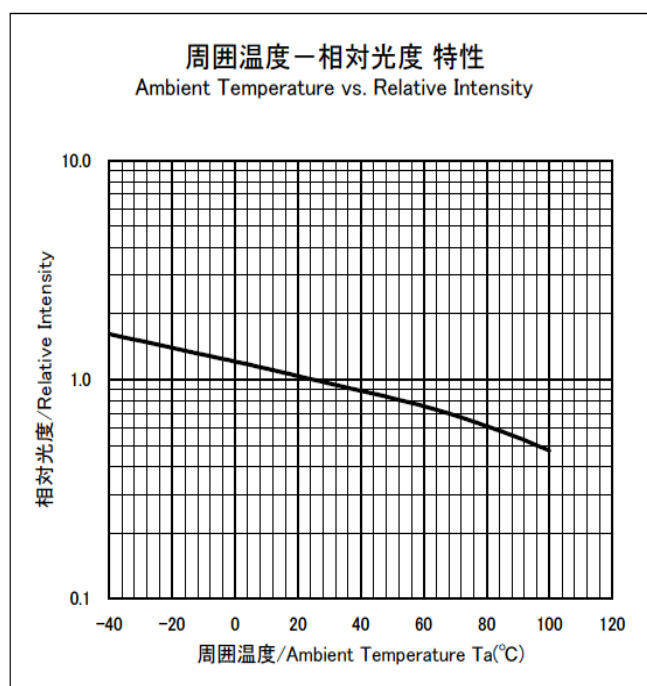
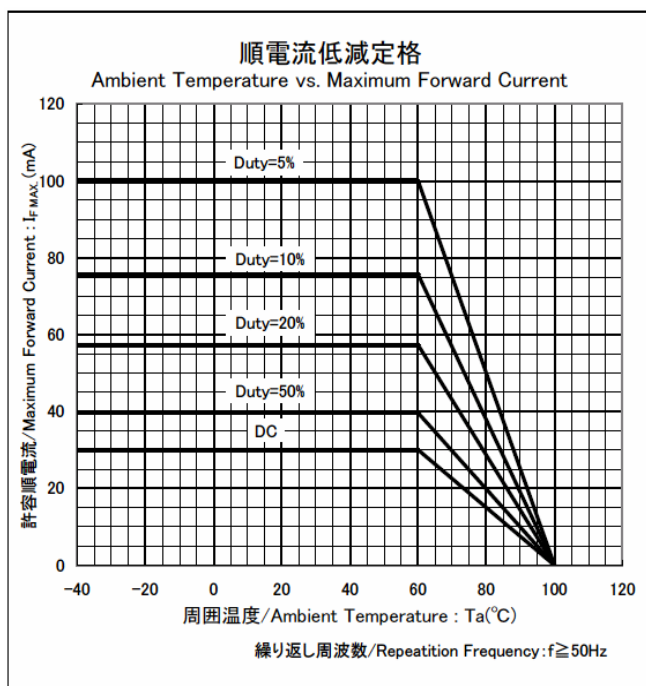

Package Dimensions

(Unit: mm)

Weight: (35.0)mg

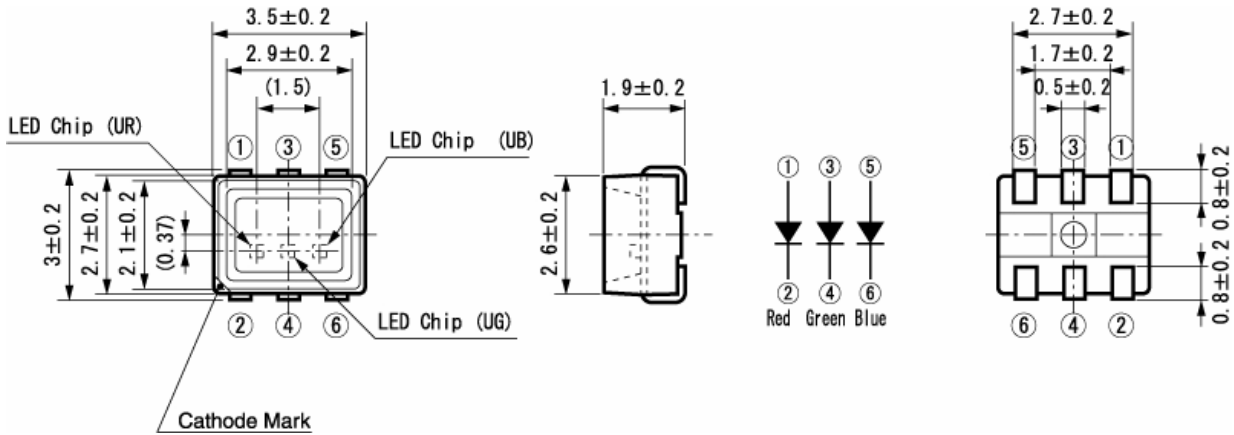

Recommended Soldering Pattern

(Unit: mm)

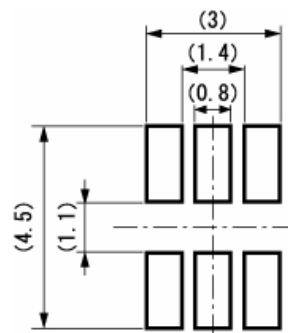

Taping Specification

(Unit: mm)

Quantity: 2,000pcs/ reel (standard)

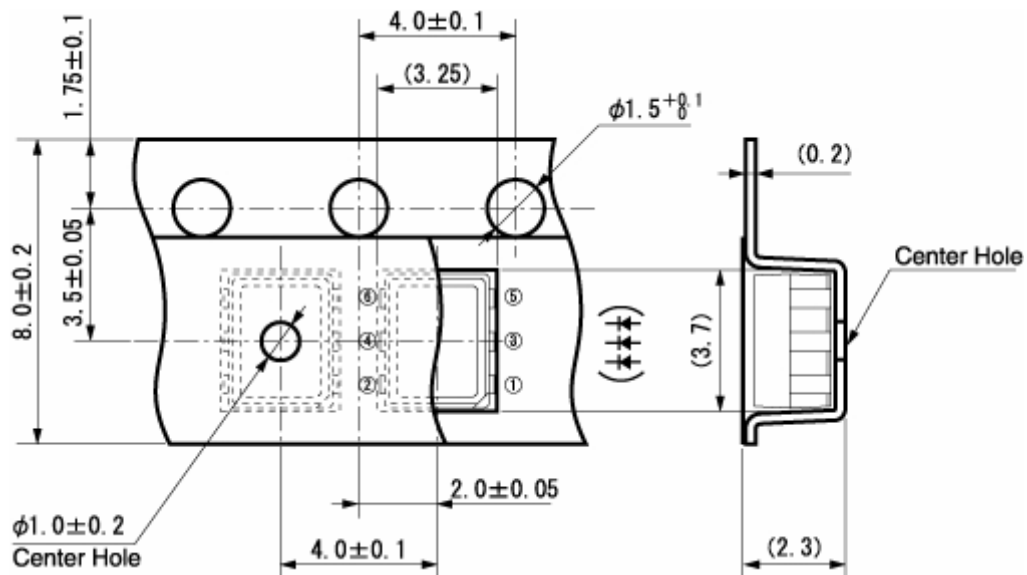

Reflow Soldering Conditions

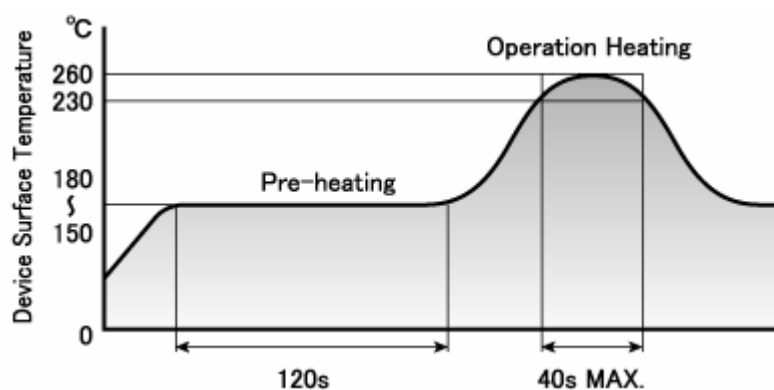

- 1) The above profile temperature gives the maximum temperature of the LED resin surface. Please set the temperature so as to avoid exceeding this range.
- 2) Total times of reflow soldering process shall be no more than 2 times. When the second reflow soldering process is performed, intervals between the first and second reflow should be short as possible (while allowing some time for the component to return to normal temperature after the first reflow) in order to prevent the LED from absorbing moisture.
- 3) Temperature fluctuation to the LED during the pre-heating process shall be minimized. (6°C maximum)

Manual Soldering Conditions

Iron tip temp.	350 °C	(MAX.)
Soldering time and frequency	3 s	(MAX.)
	1 time	(MAX.)

Special Notice to Customers Using the Products and Technical Information Shown in This Data Sheet

- 1) The technical information shown in the data sheets are limited to the typical characteristics and circuit examples of the referenced products. It does not constitute the warranting of industrial property nor the granting of any license.
- 2) For the purpose of product improvement, the specifications, characteristics and technical data described in the data sheets are subject to change without prior notice. Therefore it is recommended that the most updated specifications be used in your design.
- 3) When using the products described in the data sheets, please adhere to the maximum ratings for operating voltage, heat dissipation characteristics, and other precautions for use. We are not responsible for any damage which may occur if these specifications are exceeded.
- 4) The products described in the data sheets are made to be used in standard electronic applications such as office automation appliances, communication devices, audio visual, home appliances, and measuring instruments.
- 5) If the products in the data sheets are to be used for purposes other than the above which requires high level reliability and safety where failure and or malfunction of the product may cause death or other serious effects on the human body such as airplane, space activity, transportation, medical, nuclear), please contact our sales personnel.
- 6) In order to export the products or technologies described in this data sheet which are under the "Foreign Exchange and Foreign Trade Control Law," it is necessary to first obtain an export permit from the Japanese government.
- 7) No part of this data sheet may be reprinted or reproduced without prior written permission from Stanley Electric Co., Ltd.
- 8) The most updated edition of this data sheet can be obtained from the address below:
<http://www.stanley-components.com>