

MSL-324B	MSL-324NUYL
MSL-324UB	MSL-324UG
MSL-324TG	MSL-324UYL
MSL-324UTG	MSL-324SO
MSL-324PG	MSL-324UOL
MSL-324G	MSL-324DR

Technical Data AxiaL LEDs

Features

- **Package** : Subminiature Dome package , Gull Wing
- **Viewing angle** : 25°
- **Technology** : AlGaAs (red)
 - AllnGaP (red, orange, amber, green)
 - GaP (pure green)
 - InGaN (true green, blue)
- **Wavelength** : 640 nm (red)
 - 625 nm (red), 605 nm (orange), 590 nm (amber), 573nm (green),
 - 555 nm (pure green),
 - 525 nm (true green), 470 nm (blue)
- **Grouping parameter** : luminous intensity , wavelength
- **Assembly methods** : suitable for all SMT assembly methods
- **Soldering methods** : IR reflow soldering and TTV soldering
- **Preconditioning** : acc. to JEDEC Level 2
- **Taping** : 12-mm tape with 1500/reel, ϕ 180mm



Applications

- **Automotive** : Dashboards
- **Backlighting** : LCDs , Key pads , advertising
- **Lighting** : Signal & symbol luminare , marker lights
- **Displays** : Message boards
- **Status indicators** : Consumer & industrial electronics

Package Dimensions

Unit : mm (inch)

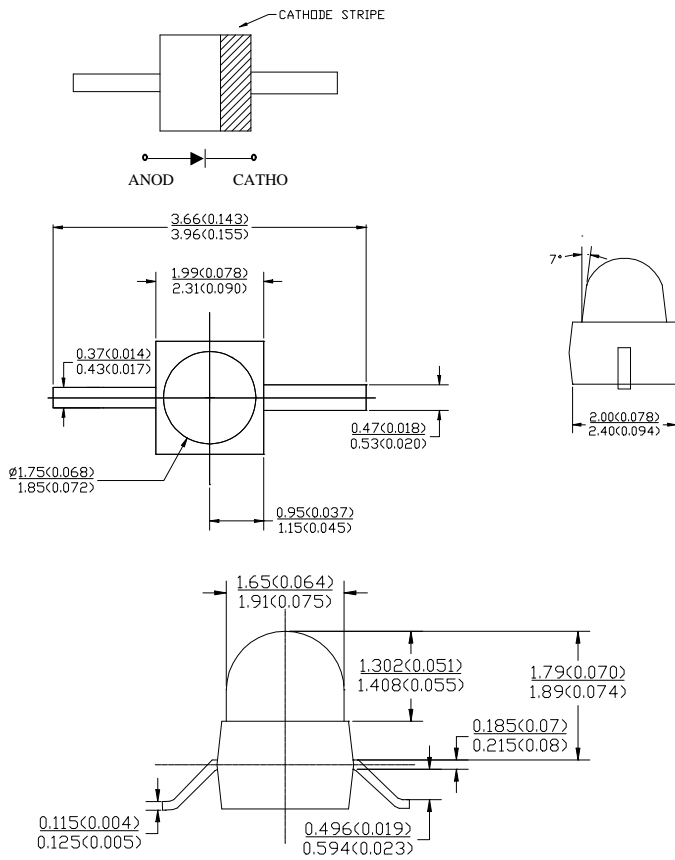

Notes :

1. All dimensions are in millimeters (inches)

Package Dimensions

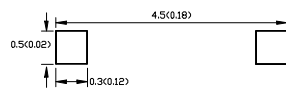

Method of Taping / Polarity and Orientation Packing unit 1500/reel

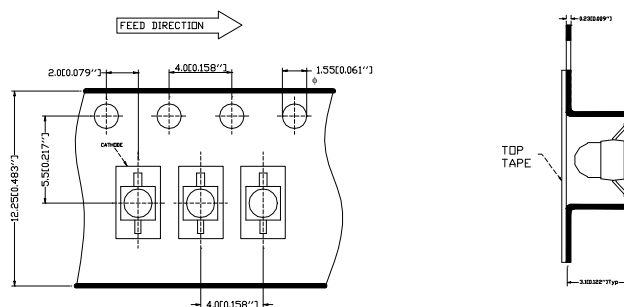

Selection Guide

Part Number	Color of Emission	d (nm)	Package Description	Viewing Angle 2q 1/2	Luminous Intensity I _v (mcd) @20mA
MSL-324B	Blue	470	Dome Nondiffused	25°	210
MSL-324UB	Blue	470			210
MSL-324TG	Ture Green	525			700
MSL-324UTG	Ture Green	525			1400
MSL-324PG	Pure Green	557			18
MSL-324G	Green	570			35
MSL-324UG	Green	572			420
MSL-324NUYL	Amber	587			210
MSL-324UYL	Amber	590			525
MSL-324SO	Orange	605			740
MSL-324UOL	Red	625			740
MSL-324DR	Red	640			160

Maximum Ratings

Parameter	Symbol	Value					Unit
		UOL,SO	B,UB	DR	NUYL	G,PG	
		UYL,UG	TG,UTG				
Operating Temp. range	T_{OP}	-40 ~ +100		-20 ~ +100			°C
Storage Temp. range	T_{stg}	-55 ~ +100					°C
Junction temperature	T_j	110					°C
Forward current	I_F	50	30			mA	
Surge current $t \leq 10\mu s, D=0.005$	I_{FM}	0.5					A
Reverse Voltage ($I_R=100\mu A$)	V_R	5					V
Power dissipation	P_{tot}	105	55	65	70	mW	
Lead Soldering Temperature [1.6 mm (0.063 in.) from body]		260°C for 5 seconds					
SMT Reflow Soldering Temperatures Convective Reflow Vapor Phase Reflow		235°C Peak, above 183°C for 90 seconds 215°C for 3 minutes					

Optical Characteristics at $T_A=25^{\circ}\text{C}$

Part Number	Luminous Intensity I_V (mcd) @ 20mA		Peak Wavelength λ_{peak} (nm)	Color, Dominant Wavelength λ_d (nm)	Viewing Angle $2\theta_{1/2}$ (Degrees)	Luminous Efficiency @ $I_F=20\text{mA}$ (lm / W)	Spectral Bandwidth at 50% $I_{\text{rel max}}$ (nm)
	Min.	Typ.	Typ.	Typ.	Typ.		
MSL-324B	63	210	468	470	25	80	26
MSL-324UB	60	210	468	470	25	80	26
MSL-324TG	250	700	523	525	25	465	36
MSL-324UTG	400	1400	518	525	25	465	35
MSL-324PG	4	18	555	557	25	630	20
MSL-324G	16	35	568	570	25	576	30
MSL-324UG	160	420	576	572	25	560	16
MSL324NUYL	63	210	589	587	25	503	20
MSL324UYL	250	525	592	590	25	490	16
MSL-324SO	250	740	611	605	25	335	20
MSL-324UOL	250	740	633	625	25	190	20
MSL-324DR	63	160	660	640	25	60	20

Electrical Characteristics at $T_A=25^\circ\text{C}$

Device Type	Forward Voltage V_F (Volts) @ $I_F = 20\text{mA}$			Reverse Current I_R (uA) @ $V_R = 5\text{V}$		Capacitance C (pF) $V_F=0$, $f=1\text{MHz}$	Thermal Resistance R_{qPIN} ($^\circ\text{C/W}$)
	Min.	Typ.	Max	Min.	Typ.	Typ.	Typ.
MSL-324B	-	3.30	4.0	0.01	10	70	110
MSL-324UB	-	3.70	4.2	0.01	10	70	110
MSL-324TG	-	3.30	4.0	0.01	10	70	110
MSL-324UTG	-	3.70	4.2	0.01	10	70	110
MSL-324PG	-	2.25	2.5	0.01	10	70	170
MSL-324G	-	2.30	2.6	0.01	10	70	170
MSL-324UG	-	2.00	2.5	0.01	10	70	170
MSL-324NUYL	-	2.10	2.4	0.01	10	70	170
MSL-324UYL	-	2.00	2.5	0.01	10	70	170
MSL-324SO	-	2.00	2.5	0.01	10	70	170
MSL-324UOL	-	2.00	2.5	0.01	10	70	170
MSL-324DR	-	1.80	2.4	0.01	10	70	170

FIG.1 Relative spektrale Emission $I_{rel} = f(\lambda)$, $T_A = 25^\circ\text{C}$, $I_F = 10\text{mA}$

$V(\lambda)$ = Standard eye response curve

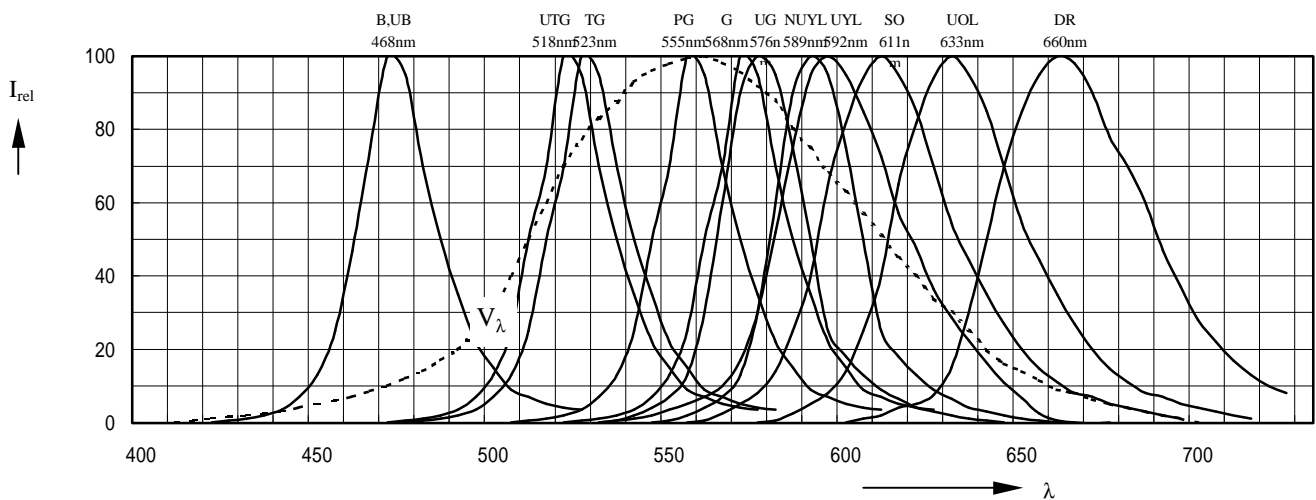

FIG.2 Forward Current $I_F = f(V_F)$

$T_A = 25^\circ\text{C}$

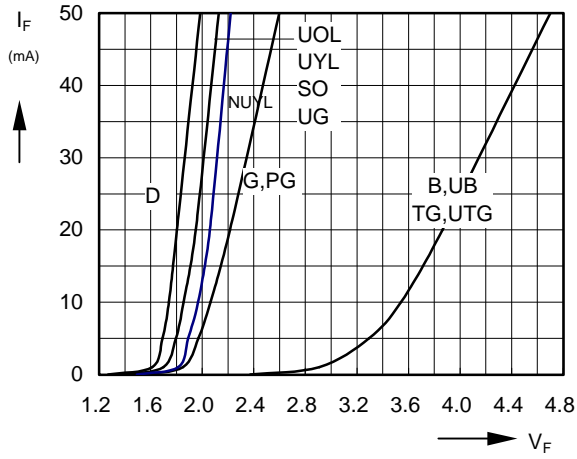

FIG.3 Relative Luminous Intensity $I_V/I_V(10\text{mA}) = f(I_F)$

$T_A = 25^\circ\text{C}$

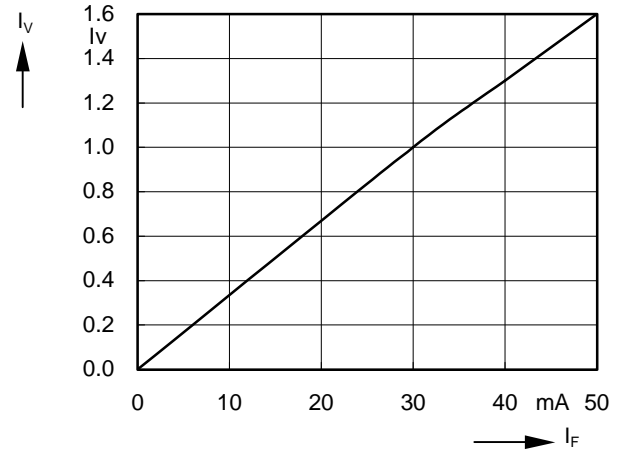

FIG.4 Relative Luminous Intensity $I_{v(\text{rel})} = f(T_A)$

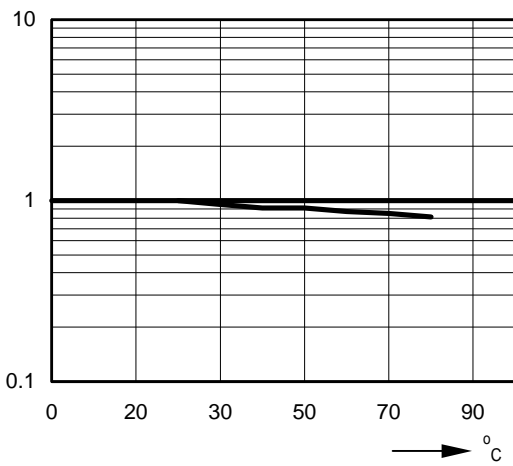

FIG.5 Radiation Characteristic $I_{\text{rel}} = f(j)$

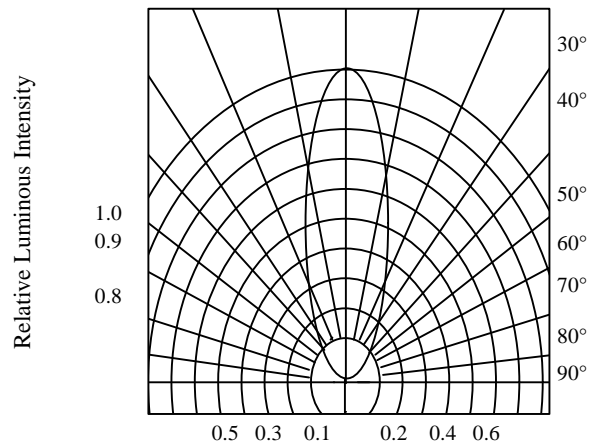
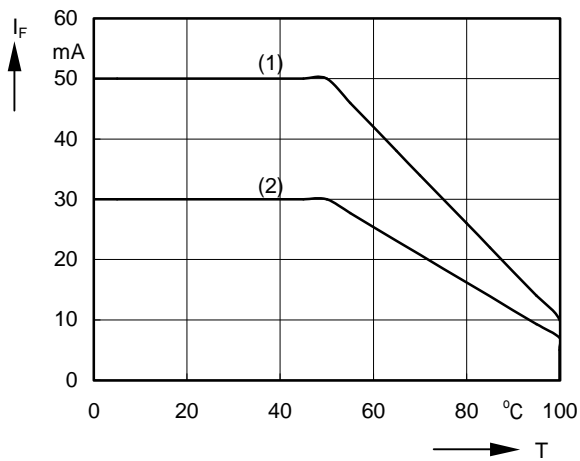

FIG.6 Max. Permissible Forward Current $I_F = f(T_A)$



(1)	(2)
UG	B
UYL	UB
SO	TG
UOL	UTG
	PG
	G
	NUYL
	DR

Part Numbering System

M S L - 3 X X U Y L

Chip Type λ_d

1:B	470nm
2:UB	470nm
3:TG	525nm
4:UTG	525nm
5:PG	557nm
6:G	570nm
7:UG	572nm
8:NUYL	587nm
9:UYL	590nm
10:SO	605nm
11:UOL	625nm
12:DR	640nm

Epoxy Color & Package

- 1:Color Diffused Epoxy
- 2:White Diffused Epoxy
- 3:Color Transparent Epoxy
- 4:Water Clear Epoxy

Package Type & Lead Frame Forming Option

- 0:Dome Straight Lead
- 1:Dome Yoke Lead
- 2:Dome Gull Wing Lead
- 3:Dome Z Bend Lead
- 4:Flat Top Straight Lead
- 5:Flat Top Yoke Lead
- 6:Flat Top Gull Wing Lead
- 7:Flat Top Z Bend Lead

3:Subminiature Axial

L:Visible Lamp

S:Surface Mount Device

M:Company Code

Intensity Bin Limits

Bin	Min.	Max.
A	0.10	0.20
B	0.16	0.32
C	0.25	0.50
D	0.40	0.80
E	0.63	1.25
F	1.00	2.00
G	1.60	3.20
H	2.50	5.00
J	4.00	8.00
K	6.30	12.50
L	10.00	20.00
M	16.00	32.00
N	25.00	50.00
P	40.00	80.00
Q	63.00	125.00
R	100.00	200.00
S	160.00	320.00
T	250.00	500.00
U	400.00	800.00
V	630.00	1250.00
W	1000.00	2000.00
X	1600.00	3200.00
Y	2500.00	5000.00

Color Bin Limits

Package	Bin	Min.	Max.
Pure Green	0	Full Distribution	
	9	552	556
	8	555	559
	7	558	562
	6	561	565
Green	0	Full Distribution	
	6	561	565
	5	564	568
	4	567	571
	3	570	574
	2	573	577
Amber	0	Full Distribution	
	1	581.5	585.0
	2	584.0	587.5
	3	586.0	590.0
	4	589.0	592.5
	5	591.5	593.5
	6	591.5	595.0
	7	594.0	597.5
Orange	0	Full Distribution	
	1	596.5	600.0
	2	599.0	602.5
	3	601.5	604.0
	4	603.8	608.2
	5	606.8	611.2
	6	609.8	614.2
	7	612.8	617.2
	8	615.8	620.2
Red	0	Full Distribution	
	2	611	618
	3	614	622
	4	616	634